

M1-1
INTERSTATE ROUTE

*Series 2000 Standard Alphabets.
**Optically space numerals about vertical centerline.

SIGN	A	B	C	D	E	F	G	H	J	K	L	M
1,2 digits	24	24	.5	7.625	10 D	6.375	5	15	15	2	2.5 C	7.658
1,2 digits	36	36	.75	11.5	15 D	9.5	7.5	22.5	22.5	2.75	4 C	12.246
1,2 digits	48	48	1	15.375	20 D	11	10	30	30	4	5 C	15.307
3 digits	30	24	.5	7.625	10 C	6.375	5	24	17	2	2.5 E	10.911
3 digits	45	36	.75	11.5	15 C	9.5	7.5	36	25.5	2.75	4 E	17.455
3 digits	60	48	1	15.375	20 C	11	10	48	34	4	5 E	21.818

COLORS: LEGEND – WHITE (RETROREFLECTIVE)
TOP – RED (RETROREFLECTIVE)
BOTTOM – BLUE (RETROREFLECTIVE)

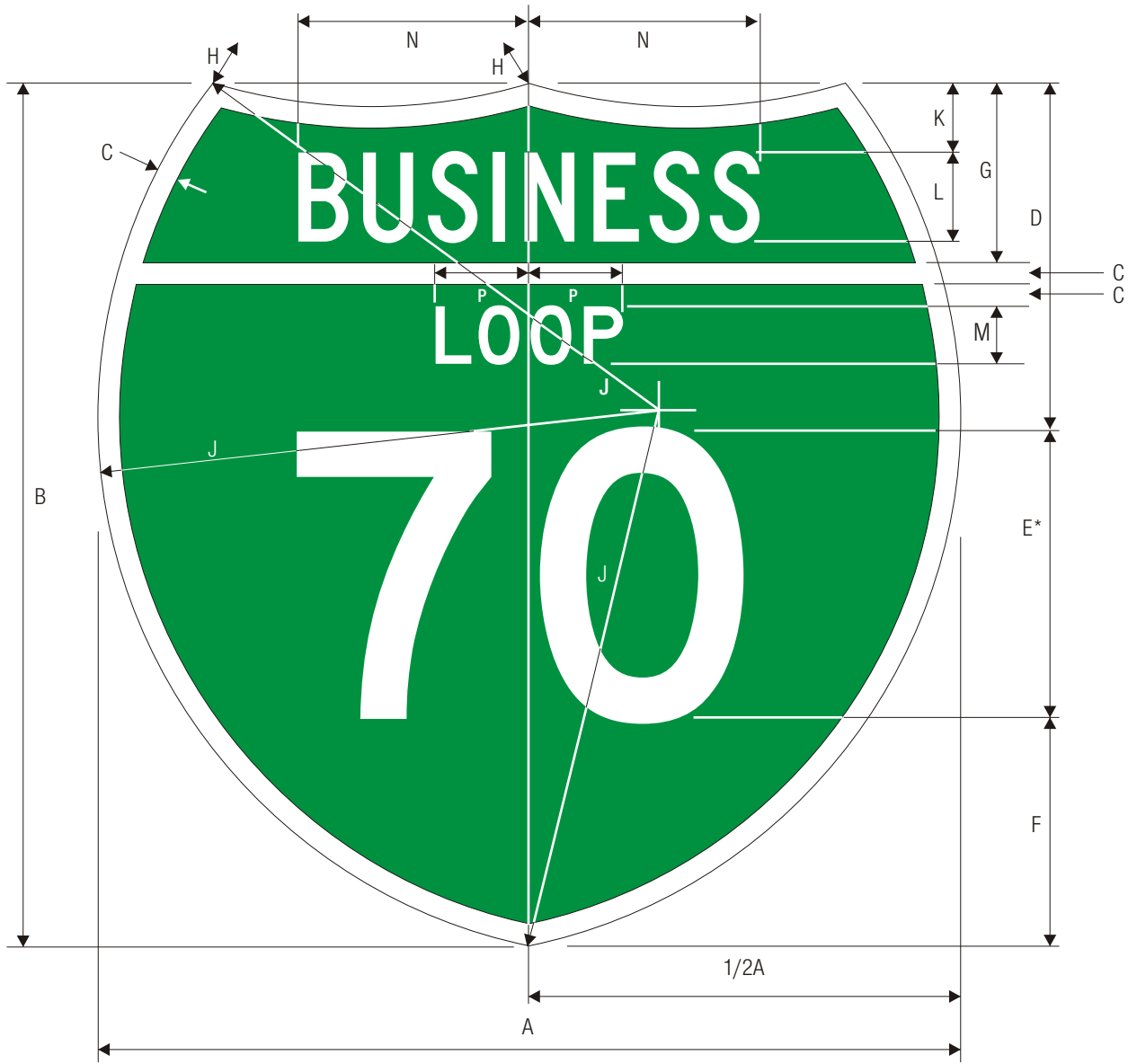

M1-2
OFF-INTERSTATE BUSINESS ROUTE (LOOP)

SIGN	A	B	C	D	E	F	G	H	J	K	L	M
1,2 digits	24	24	.5	8	10 D	6	5	15	15	2	2.5 C	1.5 D
1,2 digits	36	36	.75	12	15 D	9	7.5	22.5	22.5	3	3.75 C	2.25 D
1,2 digits	48	48	1	16	20 D	12	10	30	30	4	5 C	3 D
3 digits	30	24	.5	8	10 D	6	5	24	17	2	2.5 C	1.5 D
3 digits	45	36	.75	12	15 D	9	7.5	36	25.5	3	3.75 C	2.25 D
3 digits	60	48	1	16	20 D	12	10	48	34	4	5 C	3 D

N	P
6.625	2.5
9.938	3.75
13.25	5
6.625	2.5
9.938	3.75
13.25	5

*Optically space numerals about vertical centerline.

COLORS: LEGEND — WHITE (RETROREFLECTIVE)
BACKGROUND — GREEN (RETROREFLECTIVE)

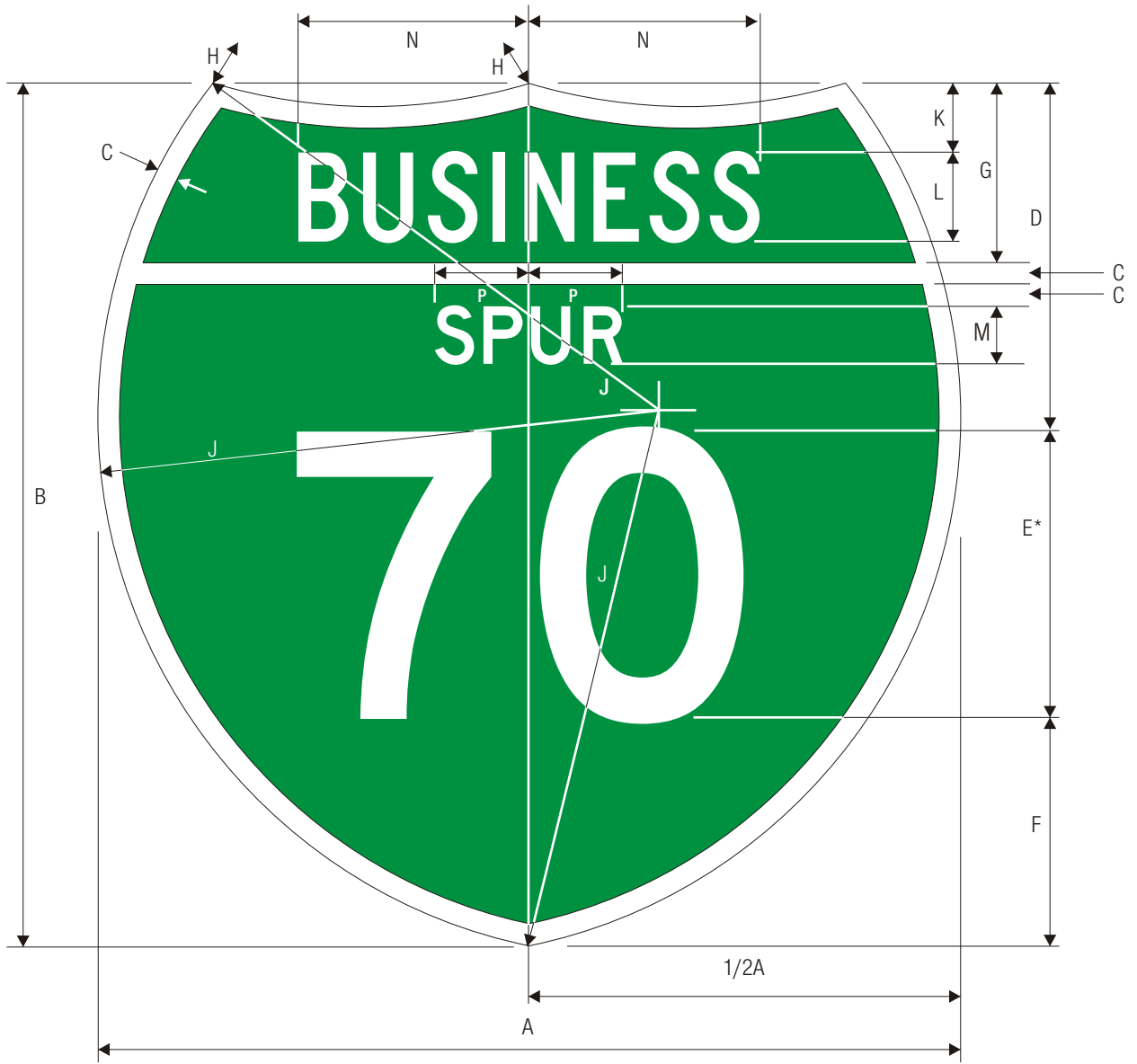

M1-3
OFF-INTERSTATE BUSINESS ROUTE (SPUR)

SIGN	A	B	C	D	E	F	G	H	J	K	L	M
1,2 digits	24	24	.5	8	10 D	6	5	15	15	2	2.5 C	1.5 D
1,2 digits	36	36	.75	12	15 D	9	7.5	22.5	22.5	3	3.75	2.25 D
1,2 digits	48	48	1	16	20 D	12	10	30	30	4	5 C	3 D
3 digits	30	24	.5	8	10 D	6	5	24	17	2	2.5 C	1.5 D
3 digits	45	36	.75	12	15 D	9	7.5	36	25.5	3	3.75	2.25 D
3 digits	60	48	1	16	20 D	12	10	48	34	4	5 C	3 D

N	P
6.625	2.563
9.938	3.844
13.25	5.125
6.625	2.563
9.938	3.844
13.25	5.125

*Optically space numerals about vertical centerline.

COLORS: LEGEND — WHITE (RETROREFLECTIVE)
BACKGROUND — GREEN (RETROREFLECTIVE)

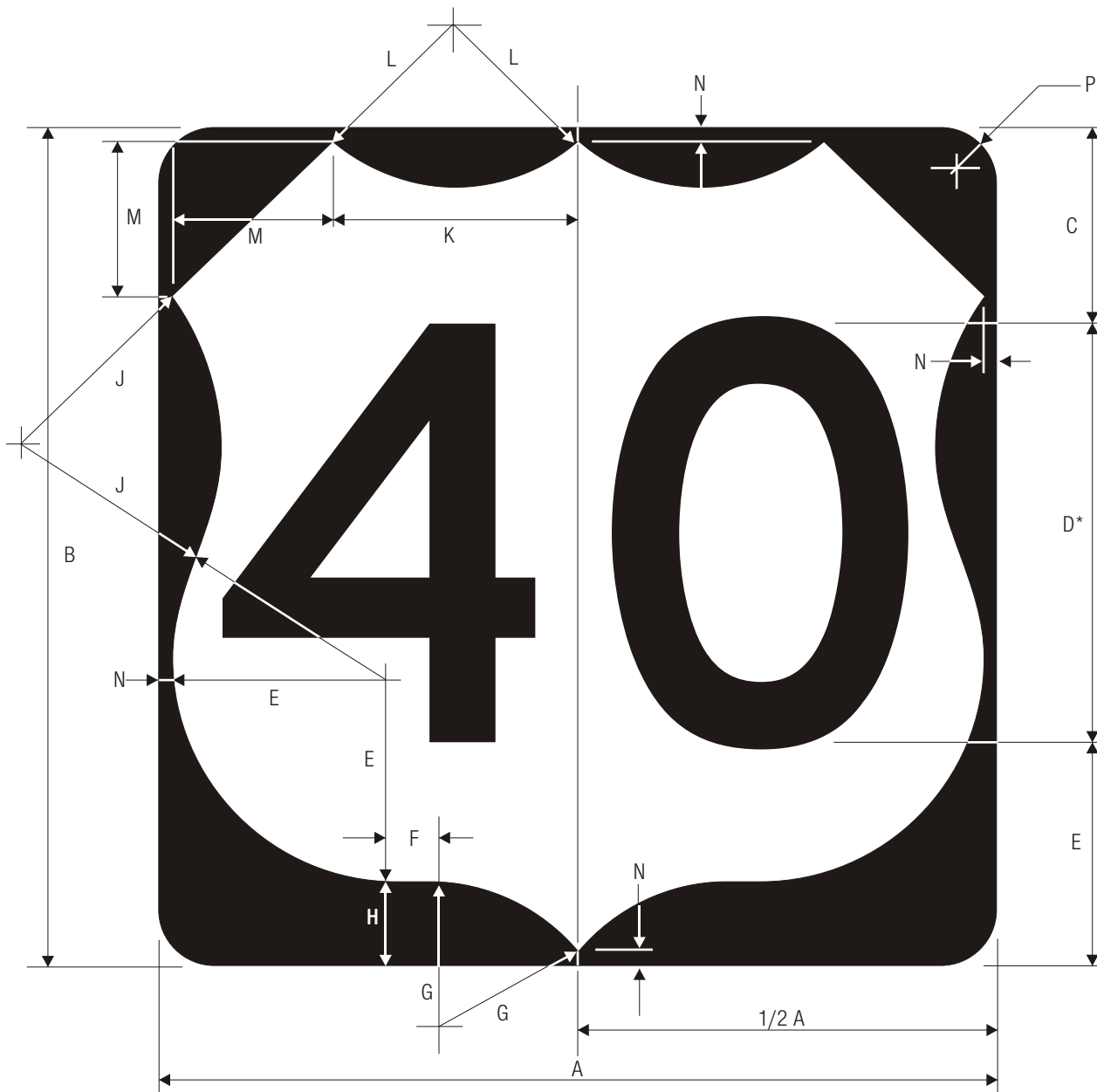

**M1-4 U.S. ROUTE MARKER
FOR INDEPENDENT USE**

*Optically space numerals about vertical centerline.

SIGN	A	B	C	D	E	F	G	H	J	K	L	M
1,2 digits	24	24	5.5	12 D	6.5	1	5.5	2.5	7.5	7	5.5	4.5
1,2 digits	36	36	8.25	18 D	9.75	1.5	8.25	3.75	11.25	10.5	8.25	6.5
1,2 digits	48	48	11	24 D	13	2	11	5	15	14	11	9
3 digits	30	24	5.5	12 D	6.5	4	5.5	2.5	7.5	10	9.5	4.5
3 digits	45	36	8.25	18 D	9.75	5.5	8.25	3.75	11.25	15	14.25	6.5
3 digits	60	48	11	24 D	13	8	11	5	15	20	19	9

N	P
.5	1.5
.75	2.25
1	3
.5	1.5
.75	2.25
1	3

**COLORS: SHIELD — WHITE (RETROREFLECTIVE)
BACKGROUND — BLACK
NUMERALS — BLACK**

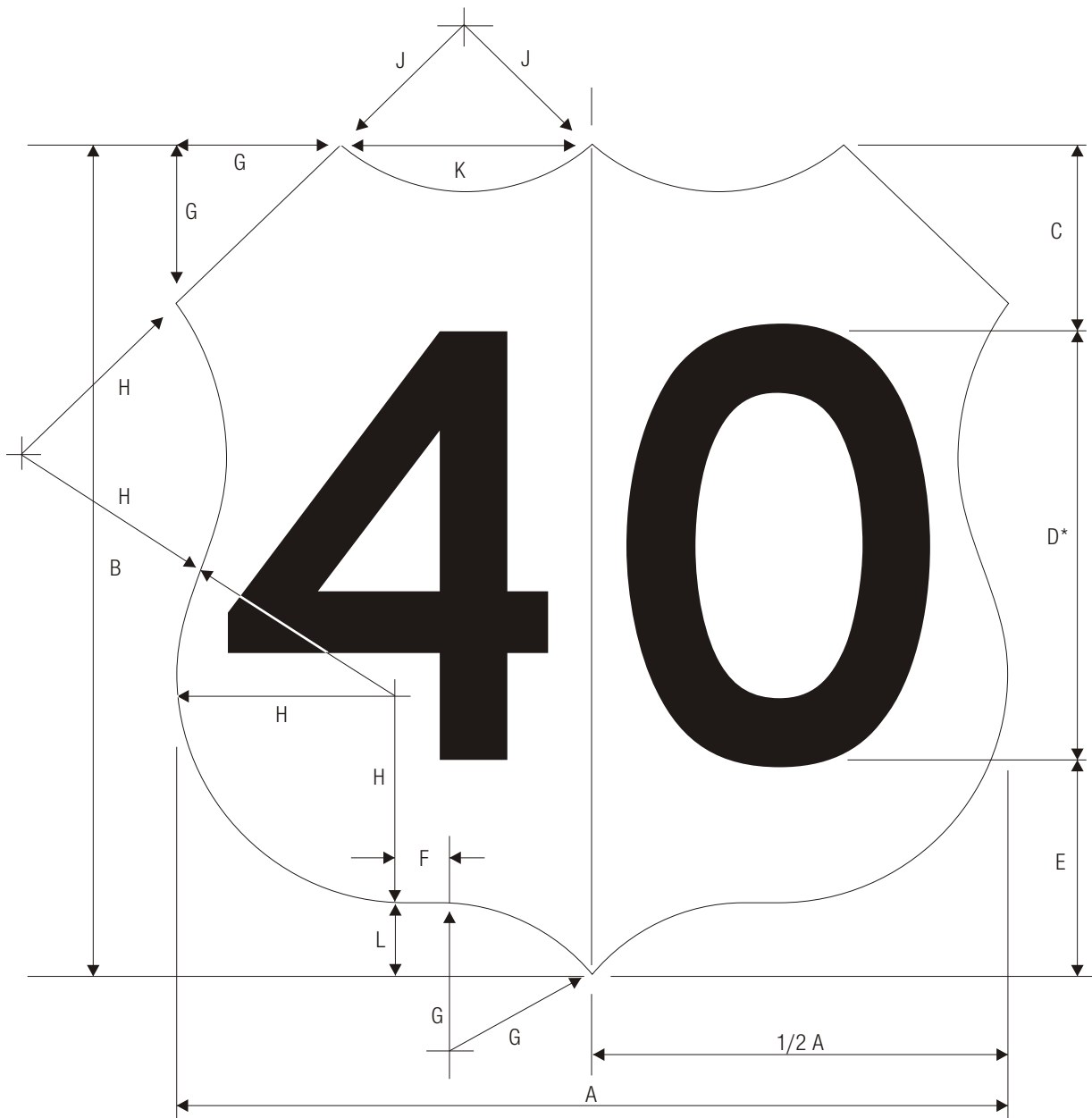

**M1-4 U.S. ROUTE MARKER
FOR GUIDE SIGN USE**

*Optically space numerals about vertical centerline.

SIGN	A	B	C	D	E	F	G	H	J	K	L
1,2 digits	24	24	5.5	12 D	6.5	1	5	7	5	7	2
1,2 digits	36	36	8.25	18 D	9.75	1.5	7.5	10.5	7.5	10.5	3
1,2 digits	48	48	11	24 D	13	2	10	14	10	14	4
3 digits	30	24	5.5	12 D	6.5	4	5	7	9	10	2
3 digits	45	36	8.25	18 D	9.75	5.5	7.5	10.5	13.5	15	3
3 digits	60	48	11	24 D	13	8	10	14	18	20	4

**COLORS: NUMERALS – BLACK
BACKGROUND – WHITE (RETROREFLECTIVE)**



M1-5
STATE ROUTE

*Optically space numerals in shield.
**Alabama Route Marker design used for illustrative purposes.

SIGN	A	B	C	D	E
1,2 digits	24	24	12 D	.5	1.5
1,2 digits	36	36	18 D	.75	2.25
1,2 digits	48	48	24 D	1	3
3 digits	30	24	12 D	.5	1.5
3 digits	45	36	18 D	.75	2.25
3 digits	60	48	24 D	1	3

COLORS: LEGEND – BLACK
SHIELD – WHITE (RETROREFLECTIVE)

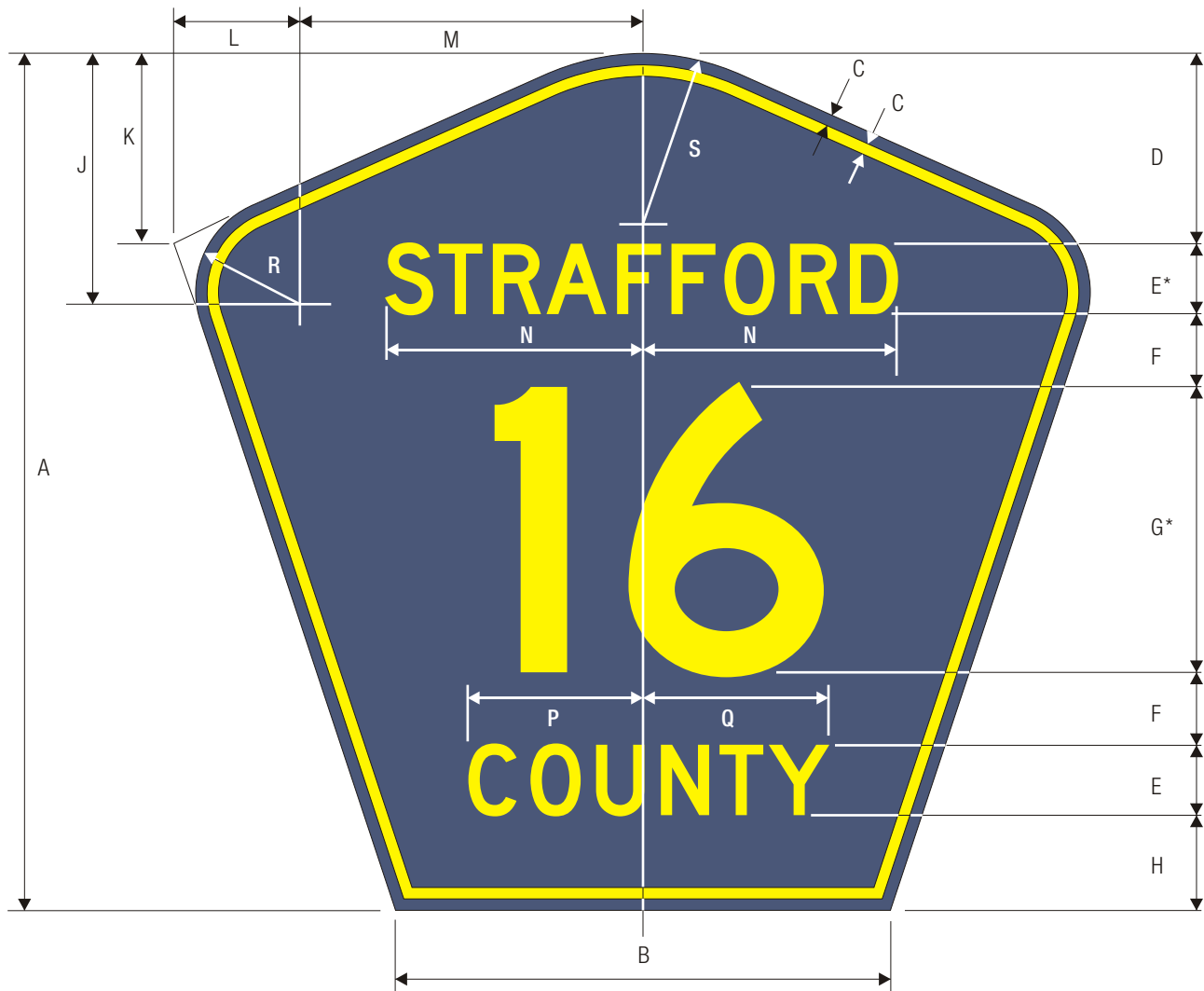

M1-6
COUNTY ROUTE

*Optically space numerals and county name about centerline.

A	B	C	D	E	F	G	H	J	K	L	M
18	10.625	.25	4	1.5 D	1.5	6 D	2	5	3.375	2.375	7
24	14.188	.375	5	2 D	2	8 D	3	6.625	5.125	3.125	9.313
30	17.75	.5	6.25	2.5 D	2.5	10 D	3.75	8.25	6.5	3.875	11.625

N	P	Q	R	S
VAR	3.75	3.875	2	5
VAR	5	5.188	2.688	5.313
VAR	6.188	6.5	3.375	6.625

COLORS: LEGEND — YELLOW (RETROREFLECTIVE)
BACKGROUND — BLUE (RETROREFLECTIVE)



M1-7
FOREST ROUTE

*Optically space numerals about vertical centerline.

A	B	C	D	E	F	G	H	J
18	12.75	.5	2.625	6 D	1.125	4	1.625	2
24	17	.5	3.5	8 D	1.75	5	2.25	2.5

COLORS: LEGEND —WHITE (RETROREFLECTIVE)
BACKGROUND —BROWN (RETROREFLECTIVE)

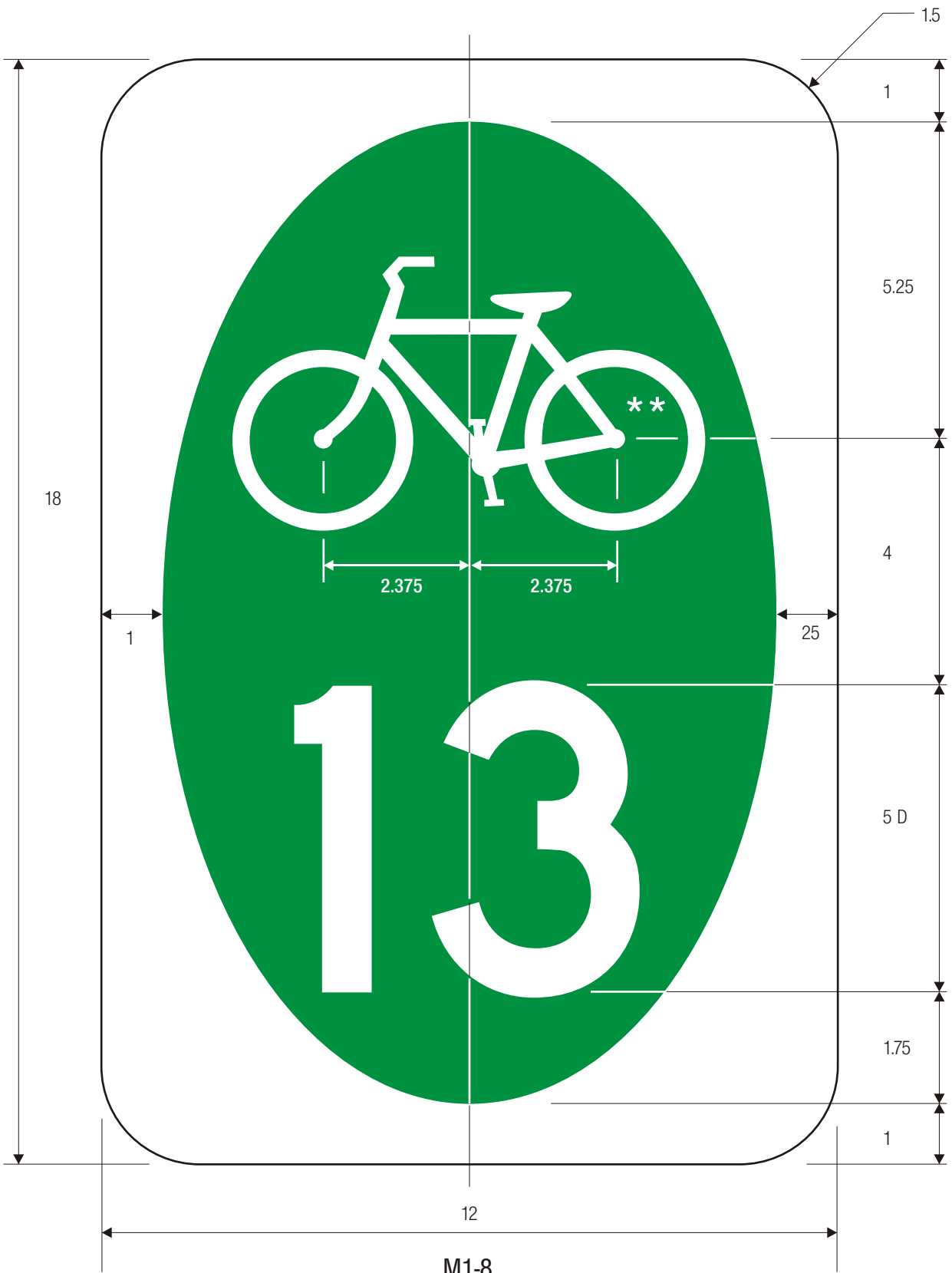

M1-8
BICYCLE ROUTE

COLORS: LEGEND & SYMBOL – WHITE (RETROREFLECTIVE)
 INNER BACKGROUND – GREEN (RETROREFLECTIVE)
 OUTER BACKGROUND – WHITE (RETROREFLECTIVE)

*Optically space numerals about centerline.

**See page 6-7 for symbol design.

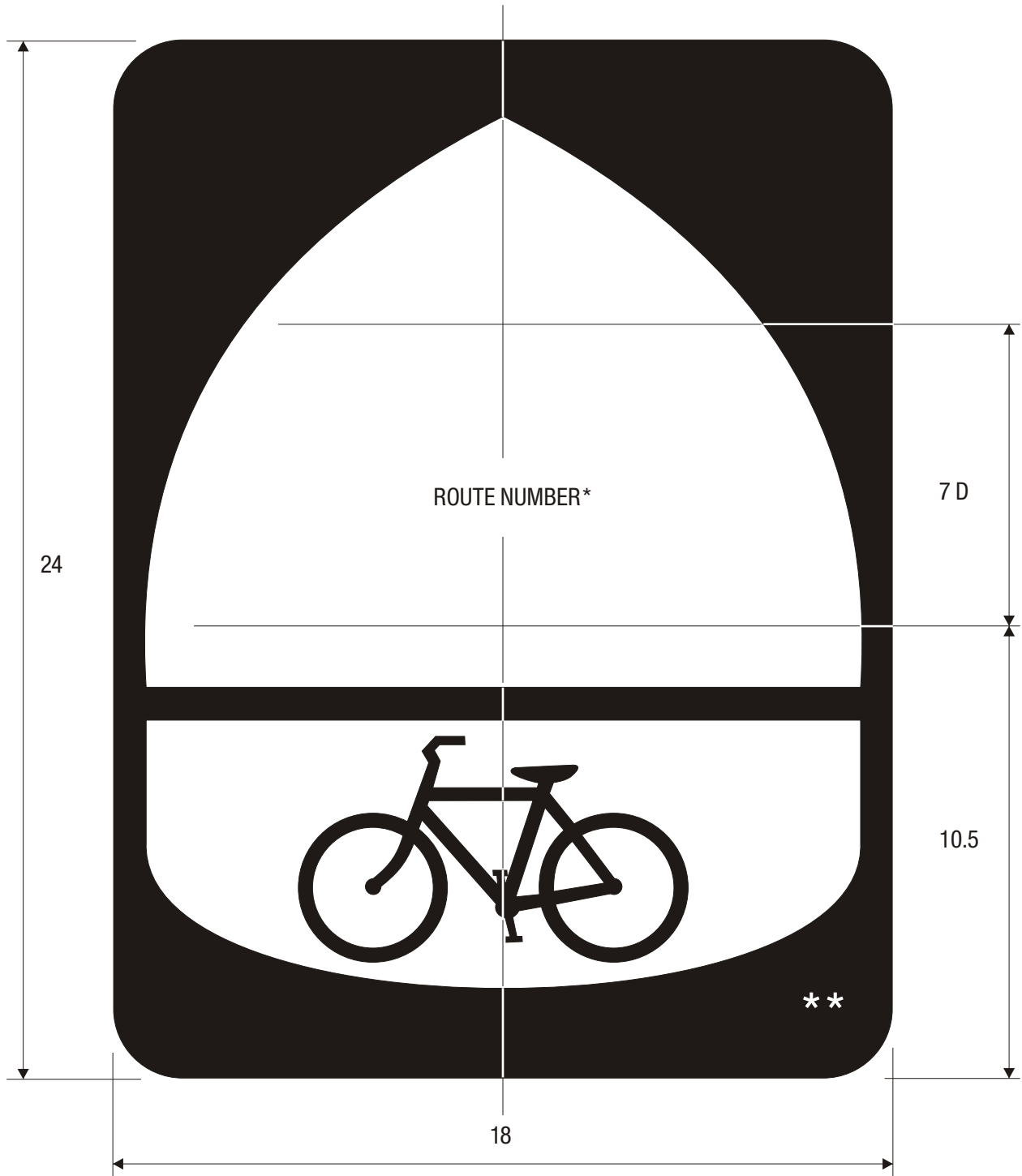

M1-9
BICYCLE ROUTE

*Optically space numerals about centerline.
** See page 6-39 for symbol design.

COLORS: LEGEND & SYMBOL — BLACK
INNER BACKGROUND — WHITE (RETROREFLECTIVE)
OUTER BACKGROUND — BLACK

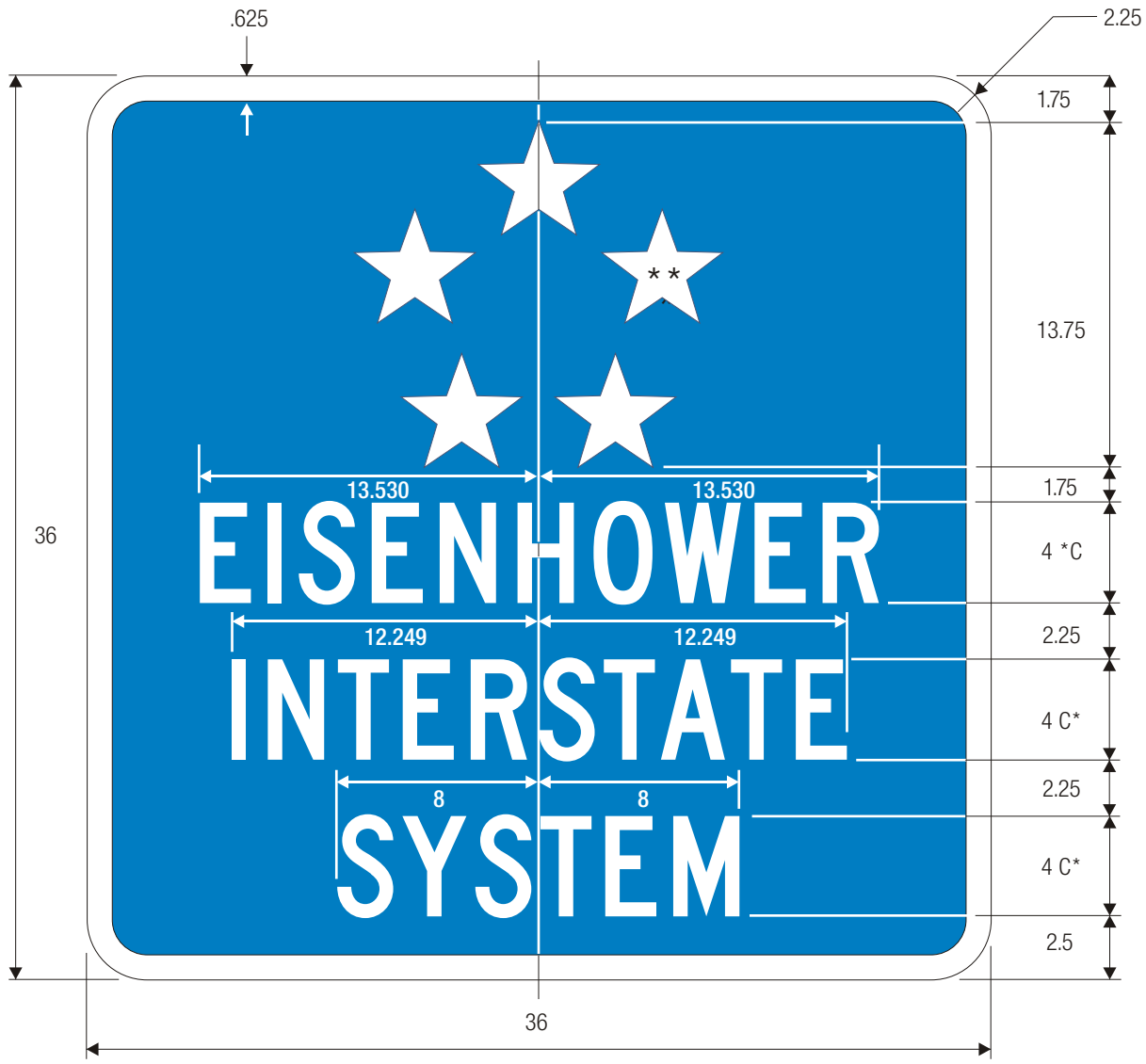

M1-10

EISENHOWER INTERSTATE SYSTEM

*Series 2000 Standard Alphabets.
 **See page 6-40 for symbol design.

COLORS: LEGEND — WHITE (RETROREFLECTIVE)
 BACKGROUND— BLUE (RETROREFLECTIVE)

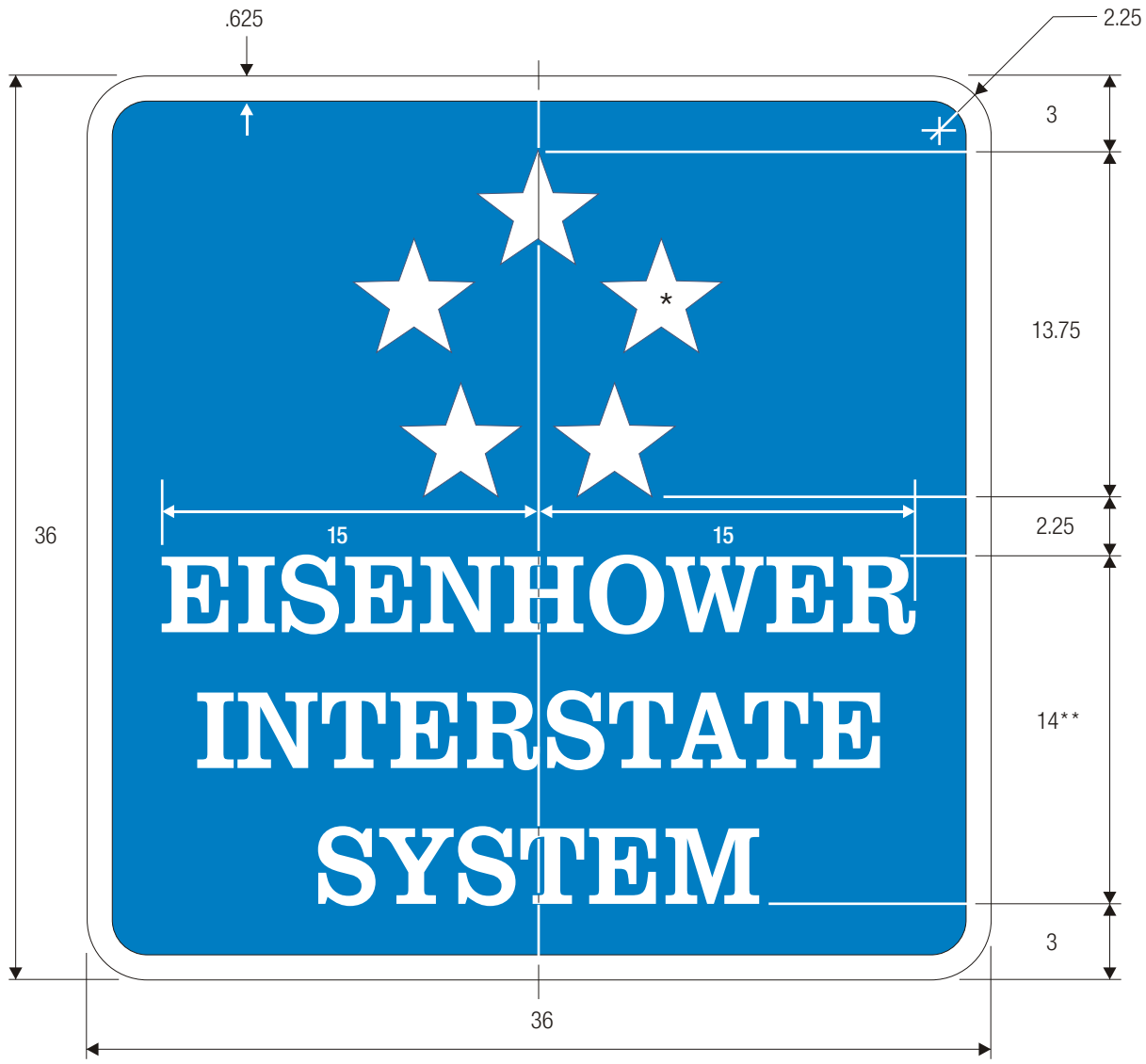

M1-10a

*See page 6-40 for symbol design.
 **See page 6-41 for lettering design.

EISENHOWER INTERSTATE SYSTEM

COLORS: LEGEND — WHITE (RETROREFLECTIVE)
 BACKGROUND — BLUE (RETROREFLECTIVE)

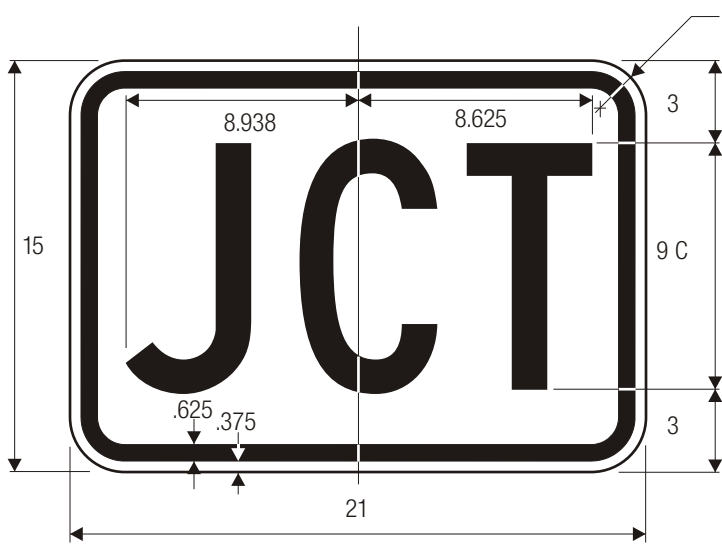

M2-1
JUNCTION AUXILIARY

COLORS: LEGEND — BLACK
BACKGROUND — WHITE (RETROREFLECTIVE)

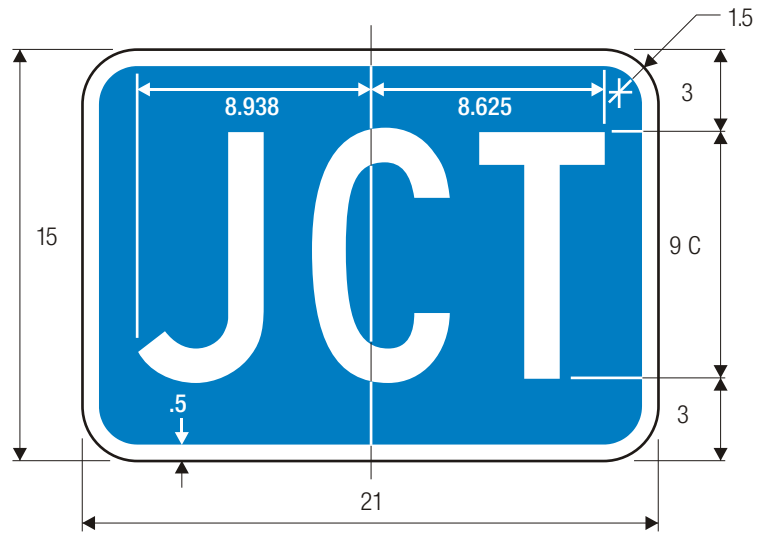

M2-1 (Interstate)
JUNCTION AUXILIARY

COLORS: LEGEND — WHITE (RETROREFLECTIVE)
BACKGROUND — BLUE (RETROREFLECTIVE)

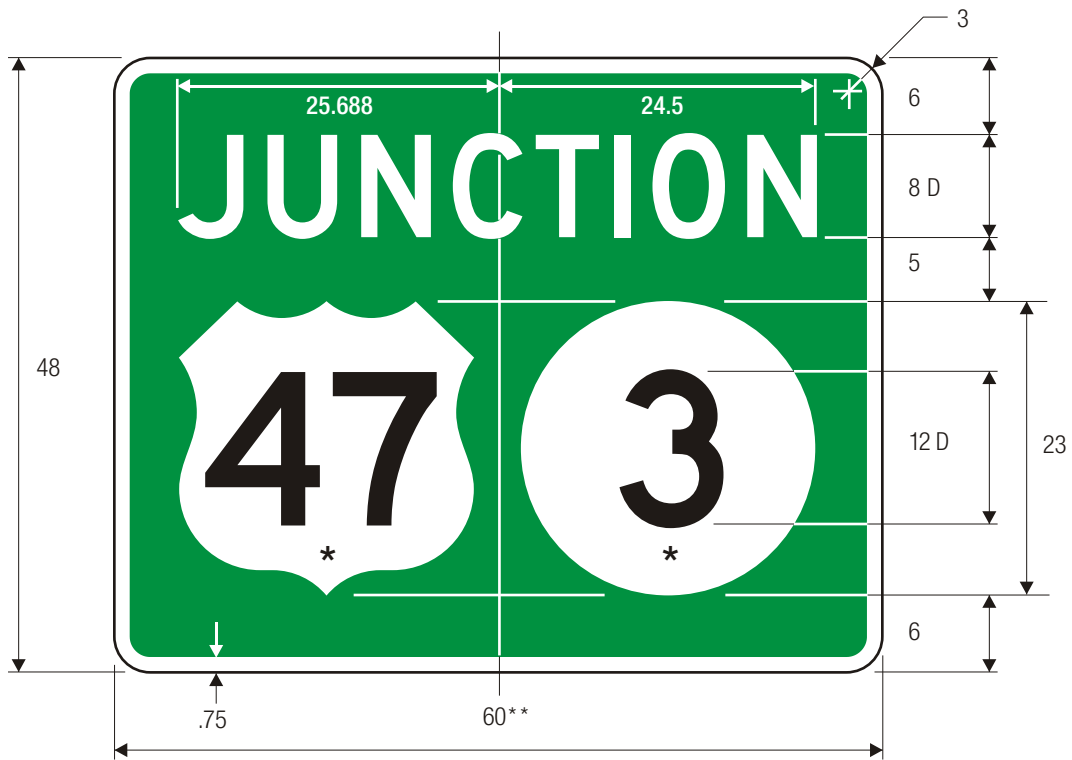

M2-2
COMBINATION JUNCTION

*Use standard shield designs.
**Increase width where more than two shields are used.

COLORS: BORDER & SHIELD — WHITE (RETROREFLECTIVE)
LEGEND LINE 1 — WHITE (RETROREFLECTIVE)
LEGEND LINE 2 — BLACK
BACKGROUND — GREEN (RETROREFLECTIVE)

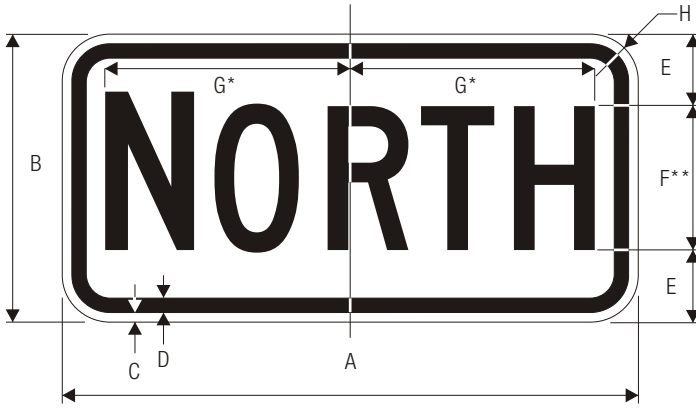

M3-1
CARDINAL DIRECTION AUXILIARY

A	B	C	D
24	12	.375	.625
30	15	.5	.75
E	F	G	H
3	6 C	10.207	1.5
3.5	8 C	12.389	1.875

*Reduce to fit for 30" size.
**Make first letter 10% larger.

COLORS: LEGEND —BLACK
BACKGROUND —WHITE (RETROREFLECTIVE)

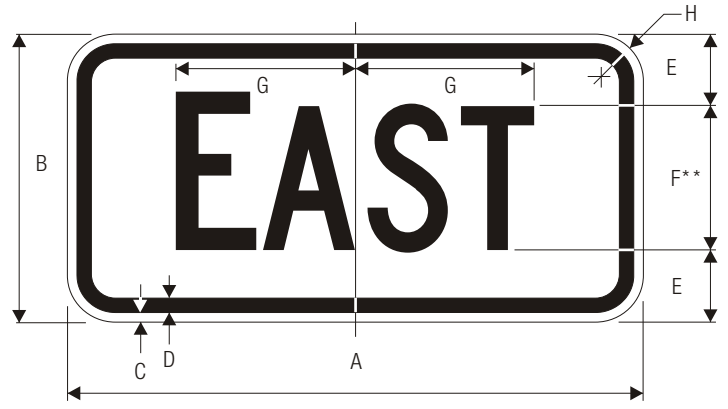

M3-2
CARDINAL DIRECTION AUXILIARY

A	B	C	D
24	12	.375	.625
30	15	.5	.75
E	F	G	H
3	6 C	7.445	1.5
3.5	8 C	9.947	1.875

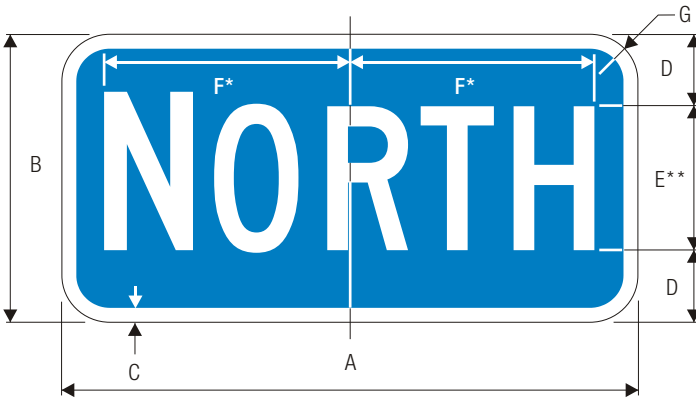

M3-1 (INTERSTATE)
CARDINAL DIRECTION AUXILIARY

A	B	C	D
24	12	.5	3
30	15	.75	3.5
E	F	G	
6 C	10.207	1.5	
8 C	12.389	1.875	

*Reduce to fit for 30" size.
**Make first letter 10% larger.

COLORS: LEGEND —WHITE (RETROREFLECTIVE)
BACKGROUND —BLUE (RETROREFLECTIVE)

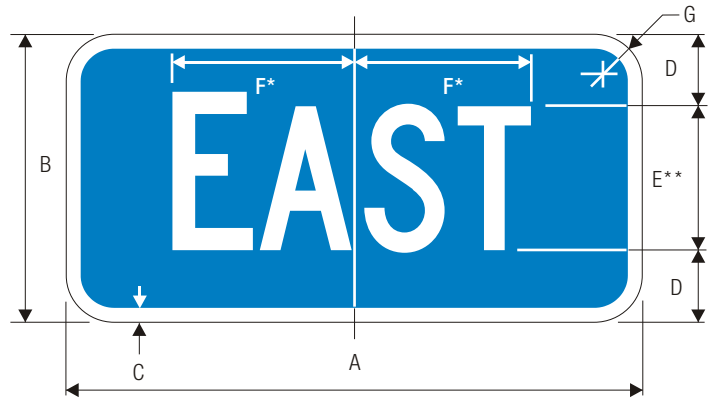

M3-2 (INTERSTATE)
CARDINAL DIRECTION AUXILIARY

A	B	C	D
24	12	.5	3
30	15	.75	3.5
E	F	G	
6 C	7.445	1.5	
8 C	9.947	1.875	

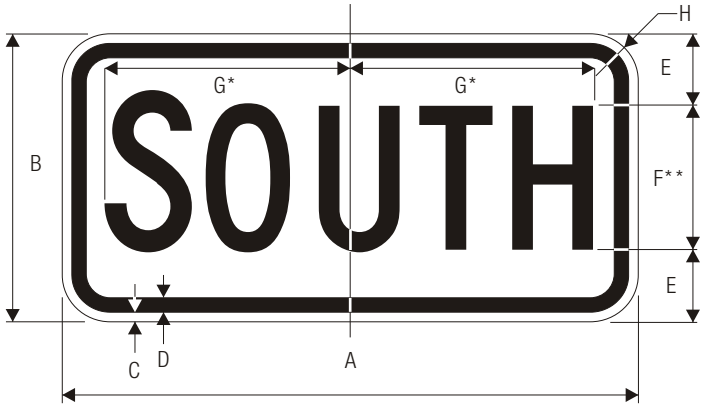

M3-3
CARDINAL DIRECTION AUXILIARY

A	B	C	D
24	12	.375	.625
30	15	.5	.75

E	F	G	H
3	6 C	10.207	1.5
3.5	8 C	12.729	1.875

*Reduce to fit for 30" size.
**Make first letter 10% larger.

COLORS: LEGEND —BLACK
BACKGROUND —WHITE (RETROREFLECTIVE)

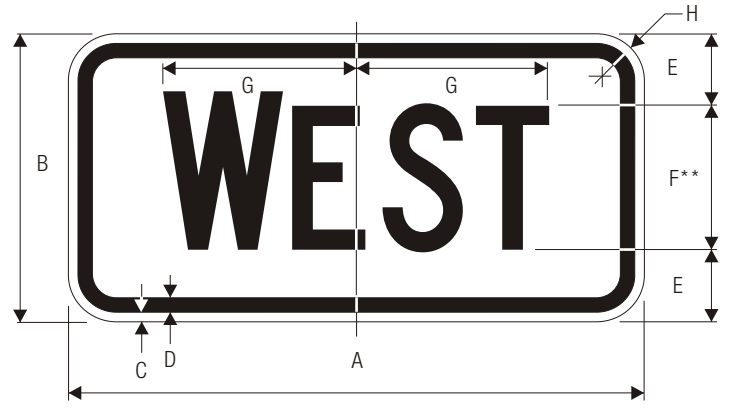

M3-4
CARDINAL DIRECTION AUXILIARY

A	B	C	D
24	12	.375	.625
30	15	.5	.75

E	F	G	H
75	6 C	8.046	1.5
87.5	8 C	10.728	1.875

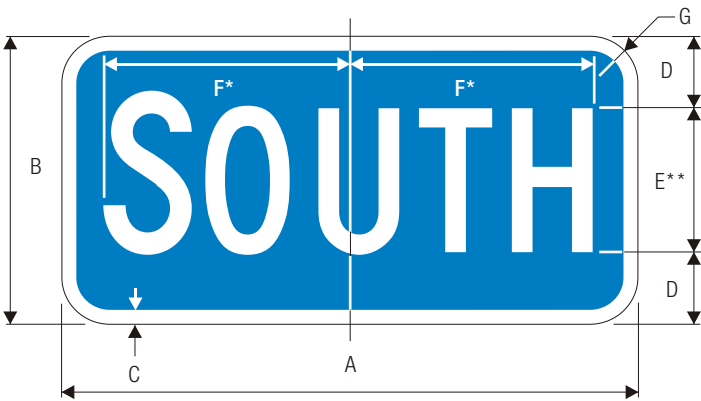

M3-3 (INTERSTATE)
CARDINAL DIRECTION AUXILIARY

A	B	C	D
24	12	.5	3
30	15	.75	3.5

E	F	G
6 C	10.207	1.5
8 C	12.729	1.875

*Reduce to fit for 30" mm size.
**Make first letter 10% larger.

COLORS: LEGEND —WHITE (RETROREFLECTIVE)
BACKGROUND —BLUE (RETROREFLECTIVE)

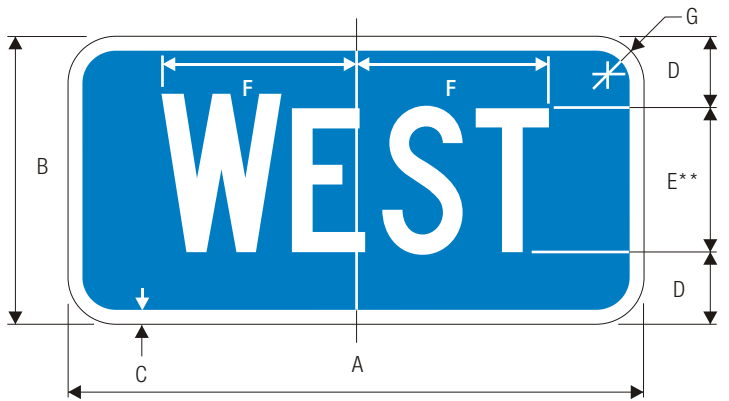

M3-4 (INTERSTATE)
CARDINAL DIRECTION AUXILIARY

A	B	C	D
24	12	.5	3
30	15	.75	3.5

E	F	G
6 C	8.046	1.5
8 C	10.728	1.875

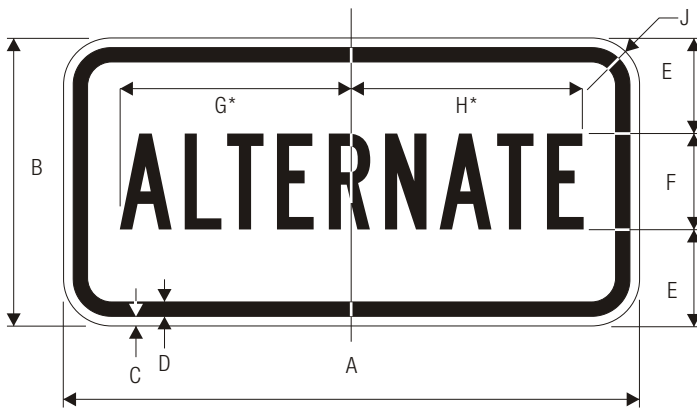

M4-1
ALTERNATE AUXILIARY

A	B	C	D	
24	12	.375	.625	
30	15	.375	.625	
E	F	G	H	J
4	4 B	9.688	9.563	1.5
4.5	6 B	12.938	12.813	1.5

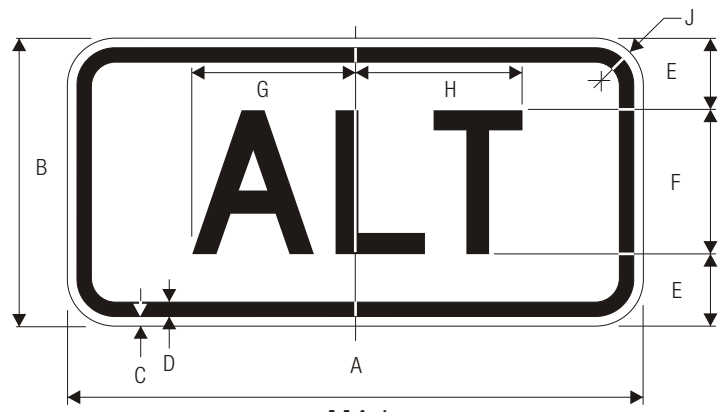

M4-1a
ALTERNATE AUXILIARY

A	B	C	D	
24	12	.375	.625	
30	15	.375	.625	
E	F	G	H	J
3	6 D	6.625	7.25	1.5
3.5	8 D	9	9.5	1.5

COLORS: LEGEND —BLACK
BACKGROUND —WHITE (RETROREFLECTIVE)

*Reduce spacing 50% for 30" size.

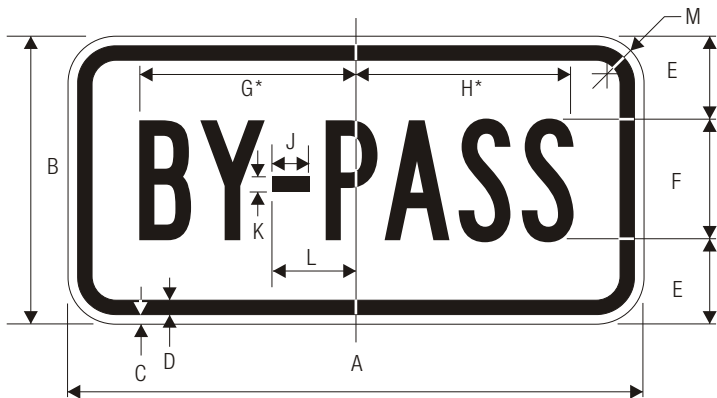

M4-2
BY-PASS AUXILIARY

A	B	C	D	E	F
24	12	.375	.625	3.5	5 B
30	15	.375	.625	4	7 B
G	H	J	K	L	M
9.375	9.625	.75	.625	3.375	1.5
12.25	12.625	1	.875	3.875	1.5

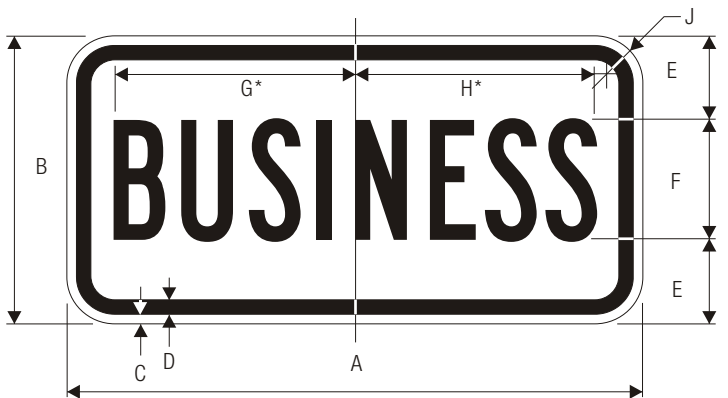

M4-3
BY-PASS AUXILIARY

A	B	C	D	
24	12	.375	.625	
30	15	.375	.625	
E	F	G	H	J
3.5	5 B	9.313	9.563	1.5
4	7 B	12.375	12.75	1.5

*Reduce spacing 40%.

COLORS: LEGEND —BLACK
BACKGROUND —WHITE (RETROREFLECTIVE)

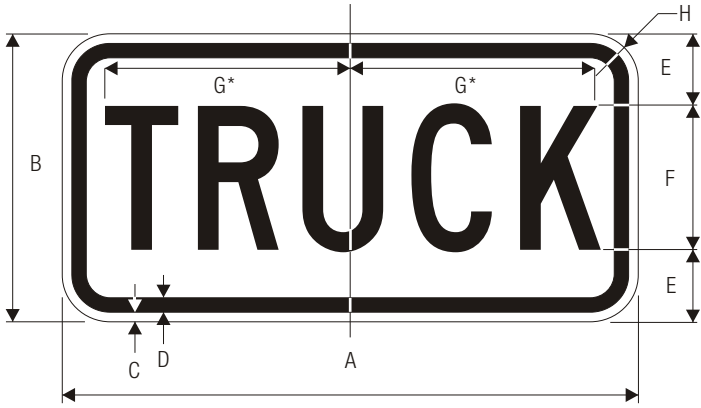

M4-4
TRUCK AUXILIARY

A	B	C	D
24	12	.375	.625
30	15	.375	.625
E	F	G	H
3	6 C	9.875	1.5
3.5	8 C	12.25	1.5

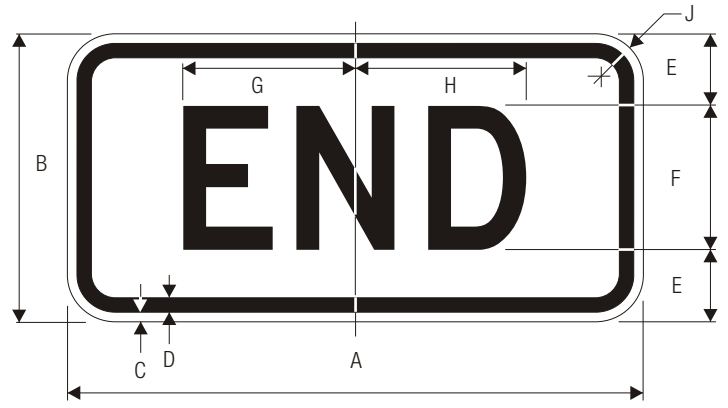

M4-6
END AUXILIARY

A	B	C	D	
24	12	.375	.625	
30	15	.375	.625	
E	F	G	H	J
3	6 D	7	7.25	1.5
3.5	8 D	9.25	9.75	1.5

COLORS: LEGEND —BLACK
BACKGROUND —WHITE (RETROREFLECTIVE)

*Reduce spacing 20% for 24" size and 50% for 30" size.

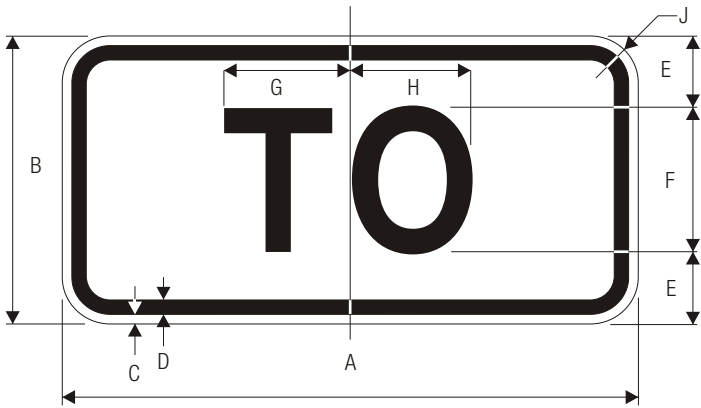

M4-5
TO AUXILIARY

A	B	C	D	
24	12	.375	.625	
30	15	.375	.625	
E	F	G	H	J
3	6 E	5.625	5	1.5
3.5	8 E	7.5	6.625	1.5

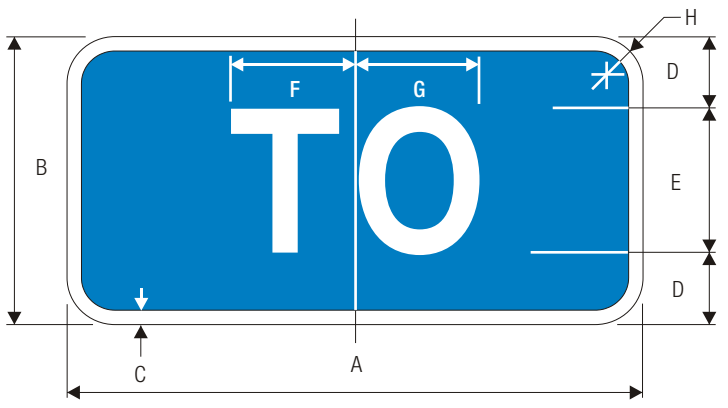

M4-5 (INTERSTATE)
TO AUXILIARY

A	B	C	D
24	12	.5	3
30	15	.5	3.5
E	F	G	H
6 E	5.625	5	1.5
8 E	7.5	6.625	1.5

COLORS: LEGEND —BLACK
BACKGROUND —WHITE (RETROREFLECTIVE)

COLORS: LEGEND —WHITE (RETROREFLECTIVE)
BACKGROUND —BLUE (RETROREFLECTIVE)

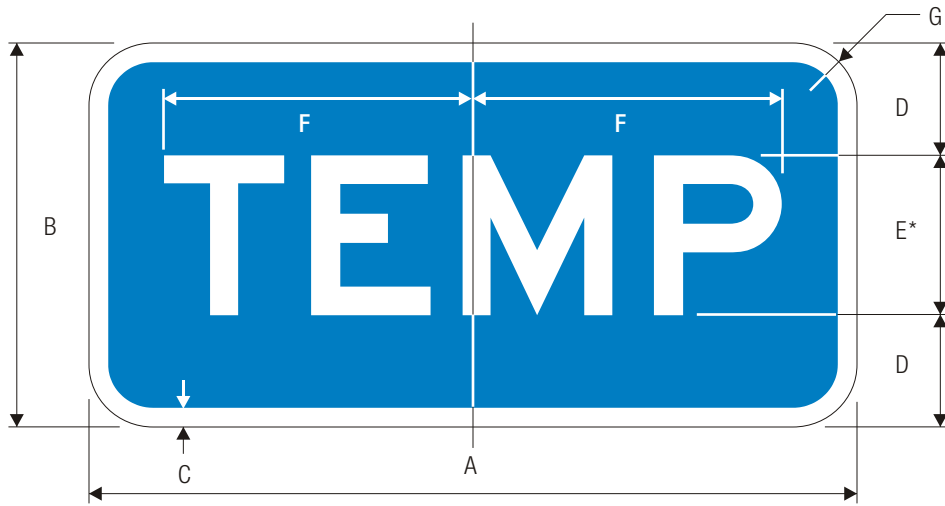

M4-7a (INTERSTATE)

TEMPORARY AUXILIARY

A	B	C	D	E	F	G
24	12	.5	3.5	5 E	9.651	1.5
30	15	.5	4.5	6 E	11.581	1.5

COLORS: LEGEND —WHITE (RETROREFLECTIVE)
 BACKGROUND —BLUE (RETROREFLECTIVE)

*Series 2000 Standard alphabets.

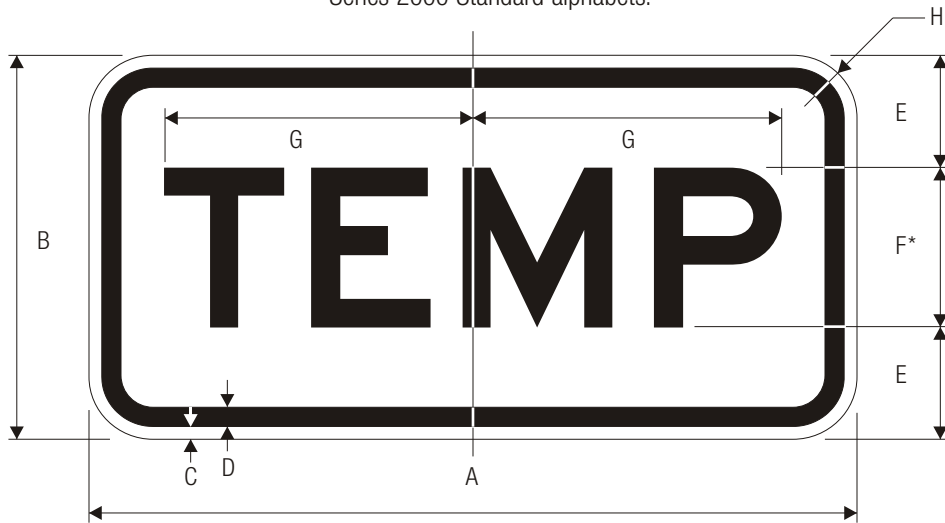

M4-7a

TEMPORARY AUXILIARY

A	B	C	D	E	F	G	H
24	12	.375	.625	3.5	5 E	9.651	1.5
30	15	.375	.625	4.5	6 E	11.581	1.5

COLORS: LEGEND —BLACK
 BACKGROUND —WHITE (RETROREFLECTIVE)

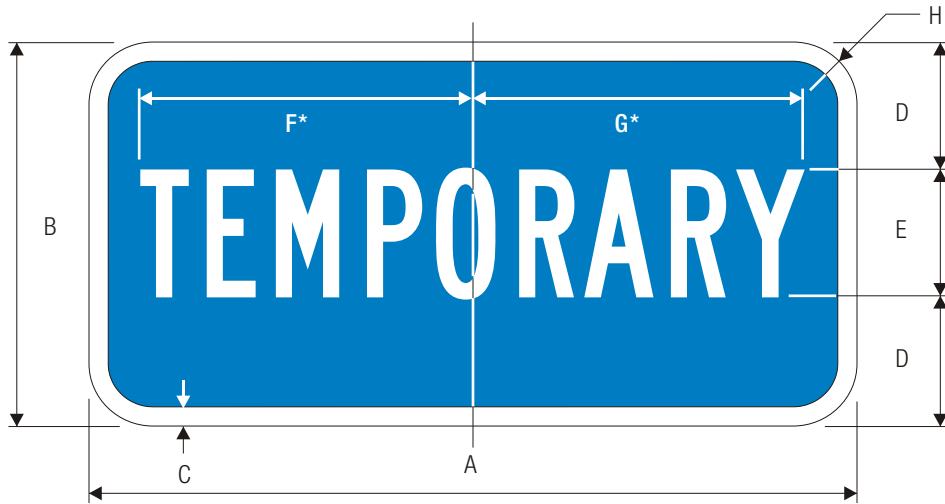

M4-7 (INTERSTATE) *Reduce spacing 20%

A	B	C	D	E	F	G	H
24	12	.5	4	4 B	10	10.125	1.5
30	15	.5	5	5 B	12.5	12.688	1.5

COLORS: LEGEND —WHITE (RETROREFLECTIVE)
 BACKGROUND —BLUE (RETROREFLECTIVE)

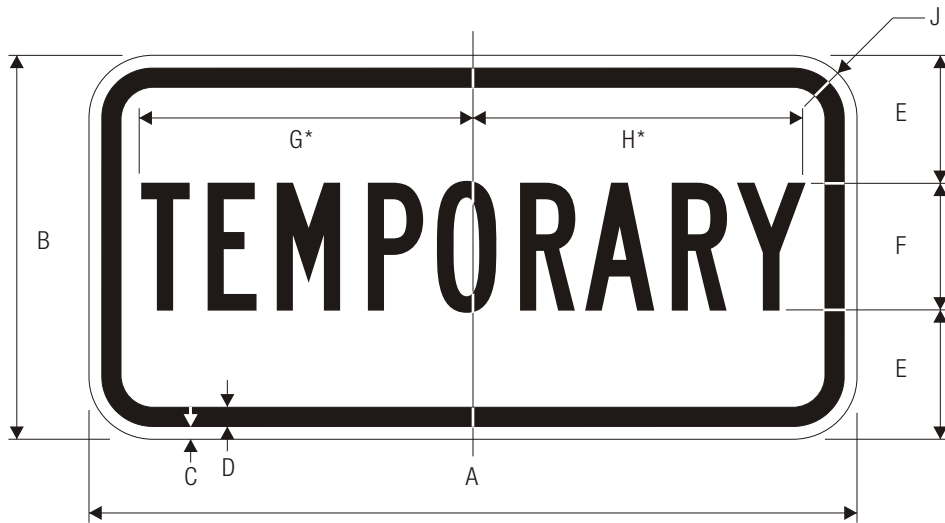

M4-7 *Reduce spacing 40%.

A	B	C	D	E	F	G	H	J
24	12	.375	.625	4	4 B	9.5	9.625	1.5
30	15	.375	.625	5	5 B	11.875	12.063	1.5

COLORS: LEGEND —BLACK
 BACKGROUND —WHITE (RETROREFLECTIVE)

BICYCLE FACILITIES

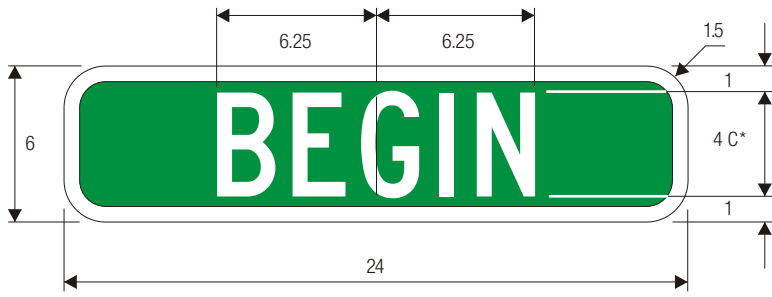

M4-11
BEGIN AUXILIARY

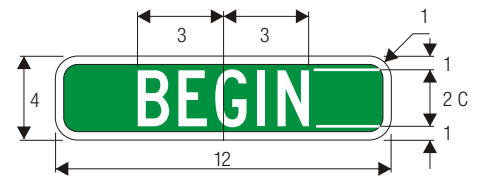

M4-11

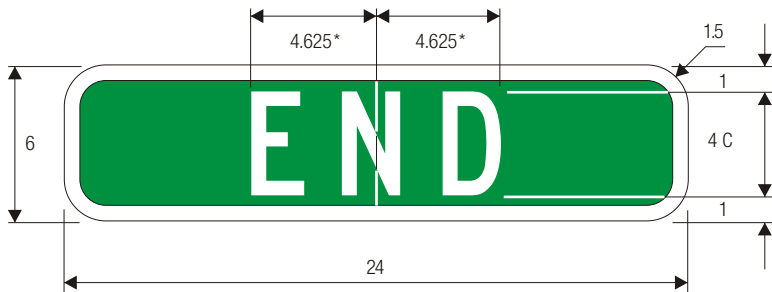

M4-12
END AUXILIARY

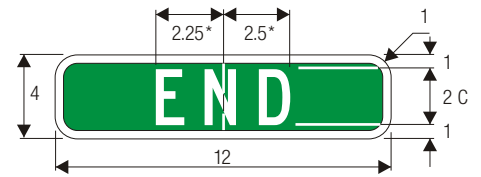

M4-12

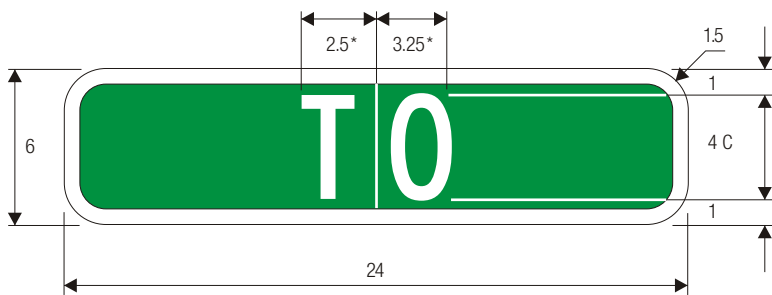

M4-13
TO AUXILIARY

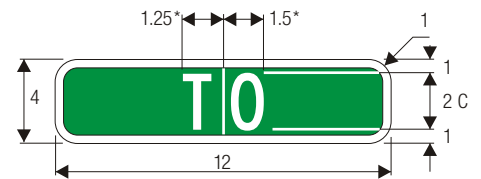

M4-13

*Increase spacing 100%

COLORS: LEGEND —WHITE (RETROREFLECTIVE)
BACKGROUND —GREEN (RETROREFLECTIVE)

DIRECTIONAL ARROW AUXILIARY

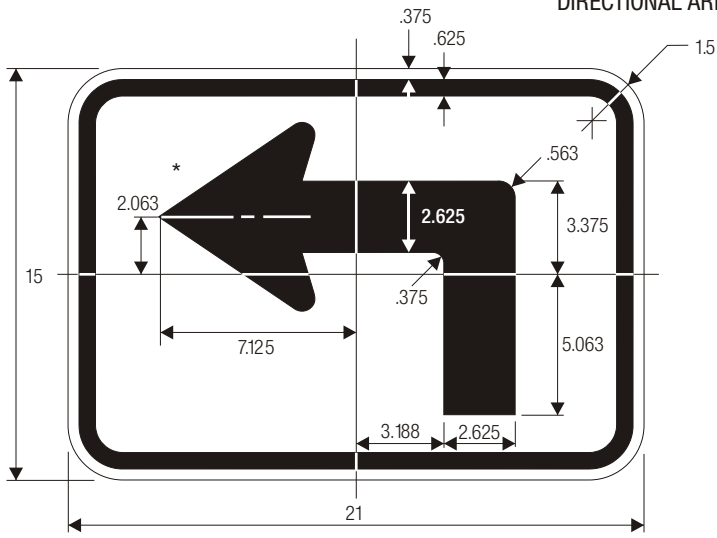

M5-1

*See page 6-2 for arrow detail.

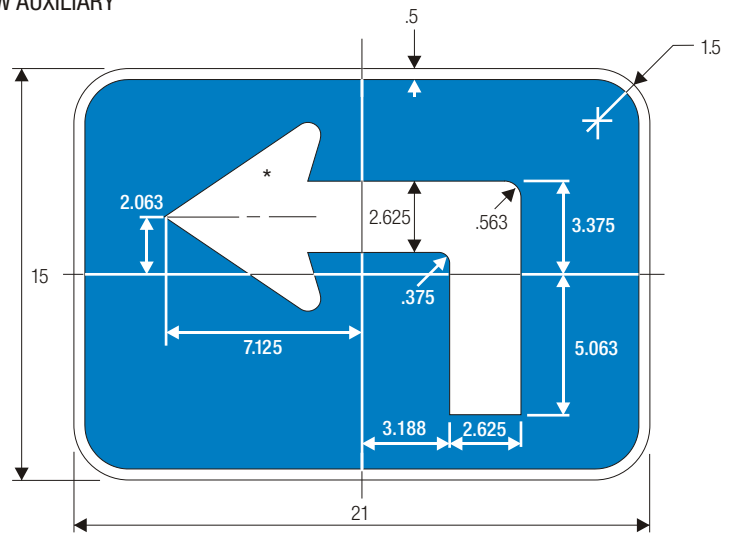

M5-1 (Interstate)

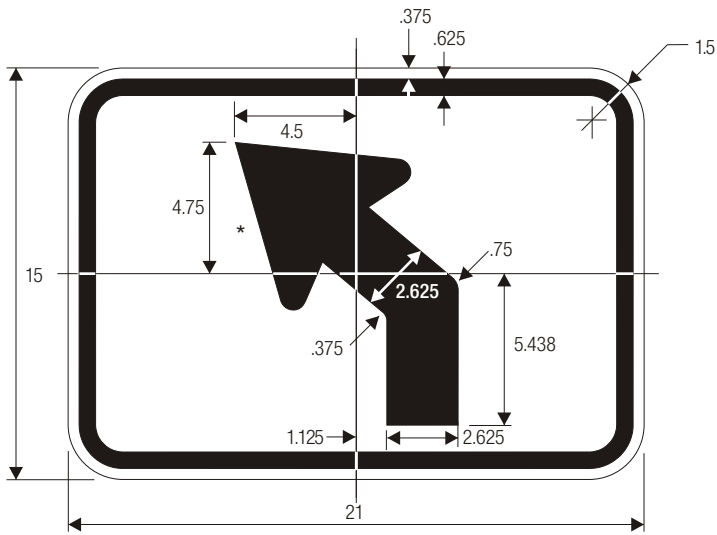

M5-2

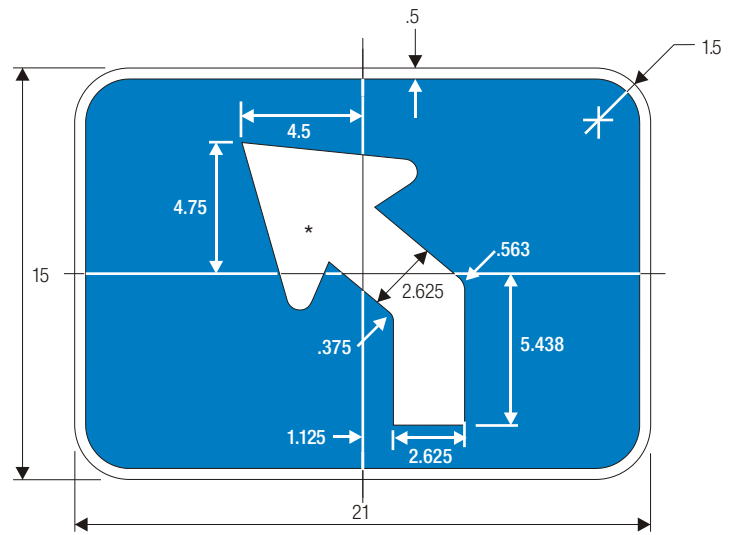

M5-2 (Interstate)

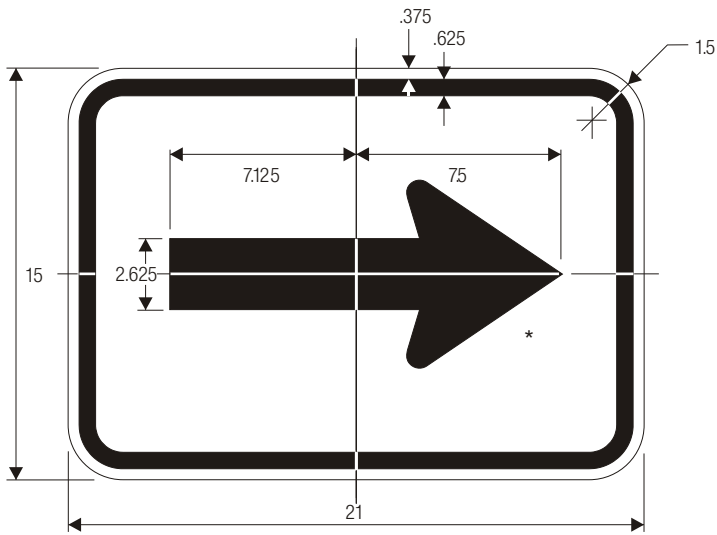

M6-1

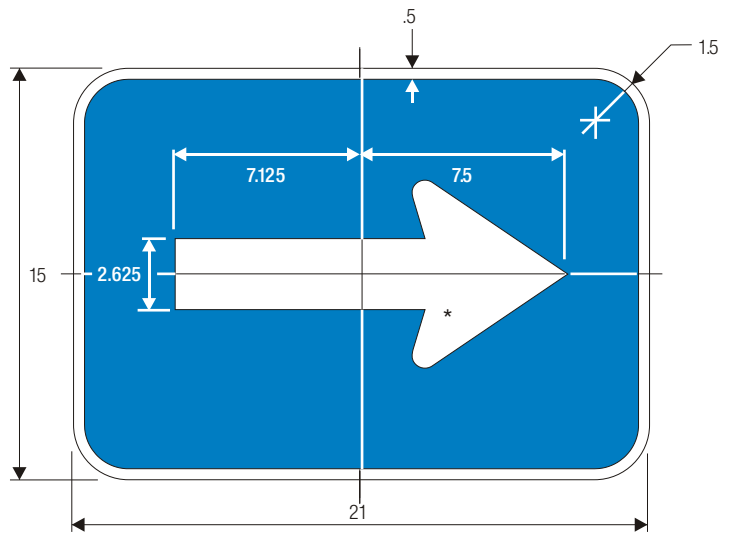

M6-1 (Interstate)

COLORS: LEGEND —BLACK
BACKGROUND —WHITE (RETROREFLECTIVE)

COLORS: LEGEND —WHITE (RETROREFLECTIVE)
BACKGROUND —BLUE (RETROREFLECTIVE)

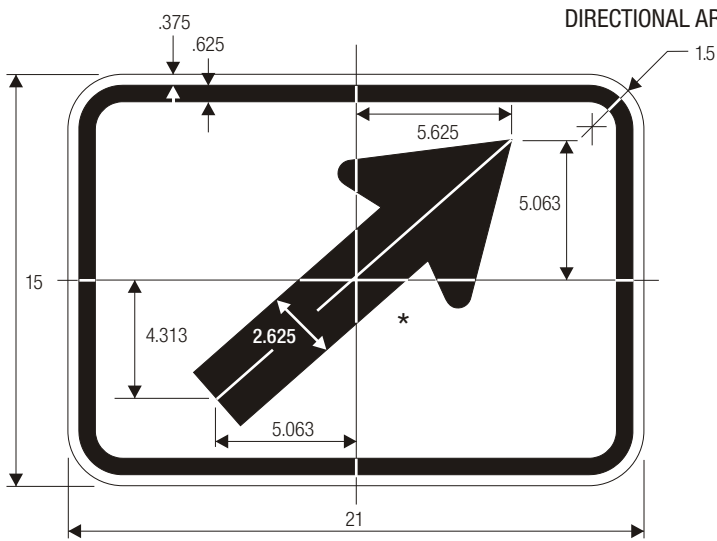

M6-2

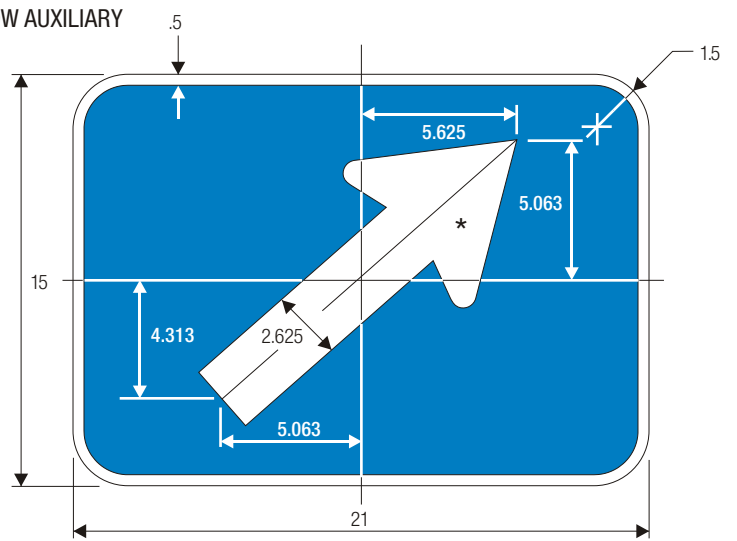

M6-2 (Interstate)

*See page 6-2 for arrow design.

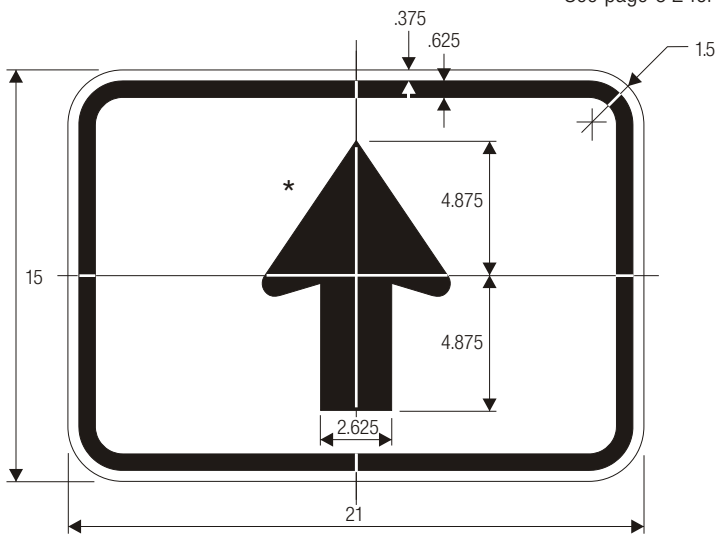

M6-3

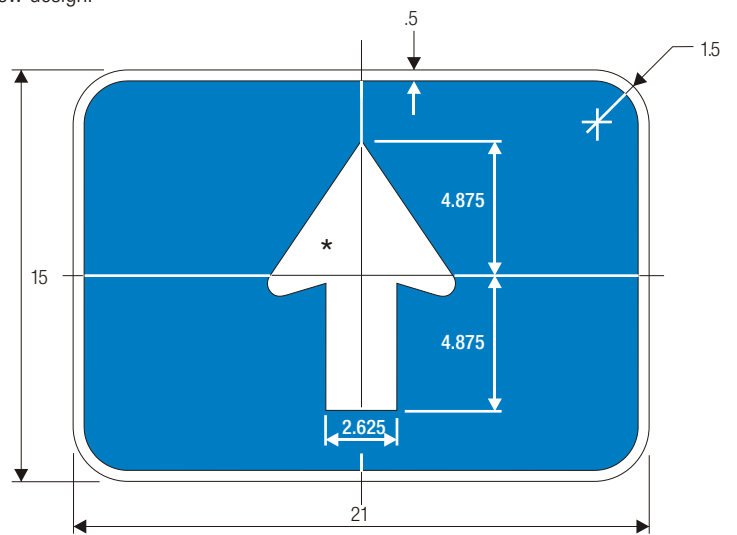

M6-3 (Interstate)

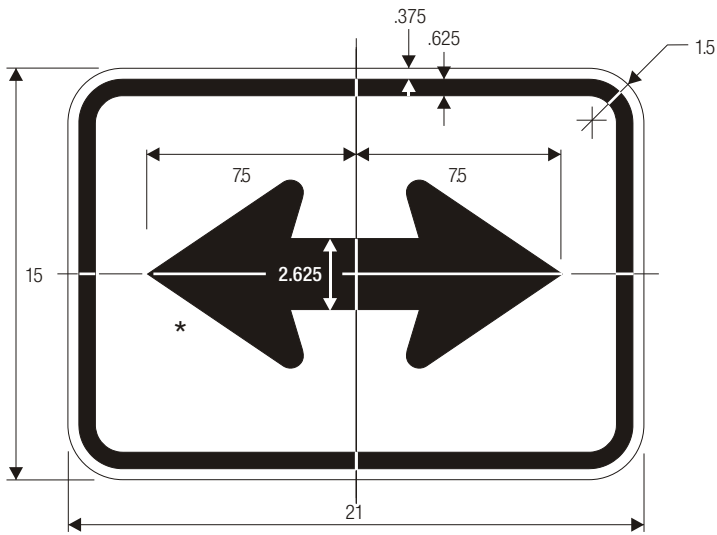

M6-4

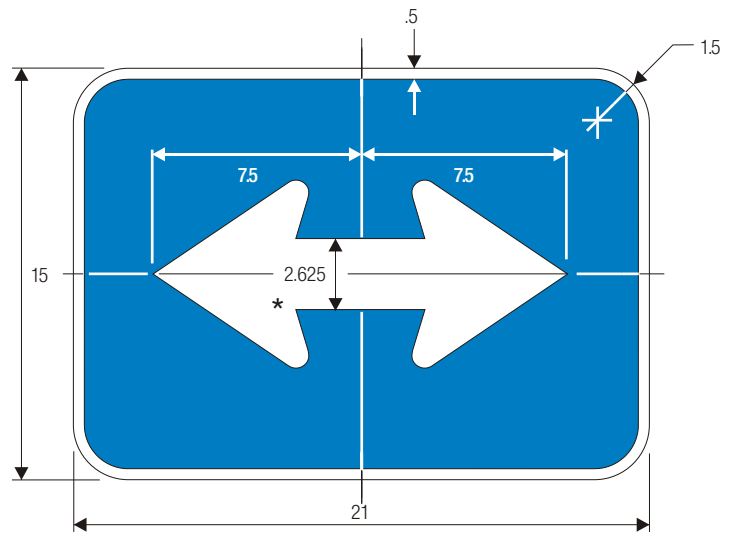

M6-4 (Interstate)

COLORS: LEGEND —BLACK
BACKGROUND —WHITE (RETROREFLECTIVE)

COLORS: LEGEND —WHITE (RETROREFLECTIVE)
BACKGROUND —BLUE (RETROREFLECTIVE)

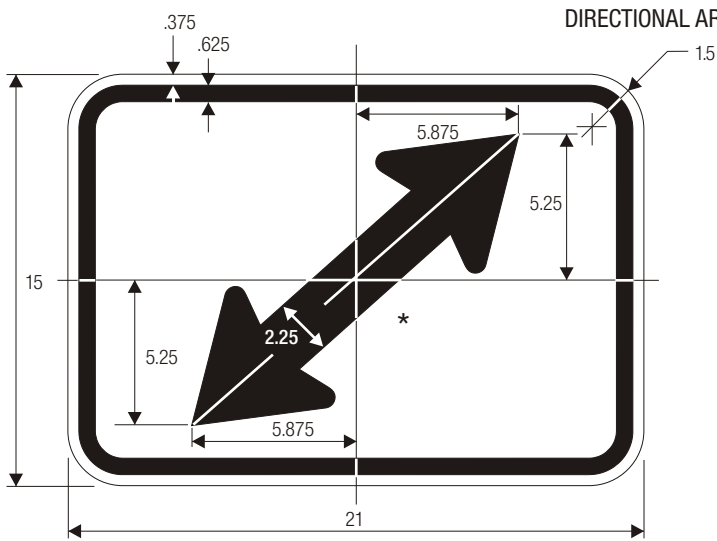

M6-5

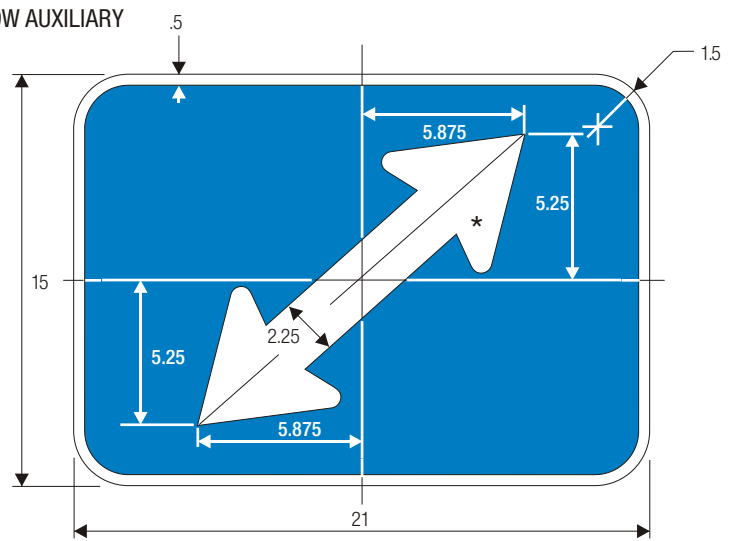

M6-5 (Interstate)

*See page 6-2 for arrow design.

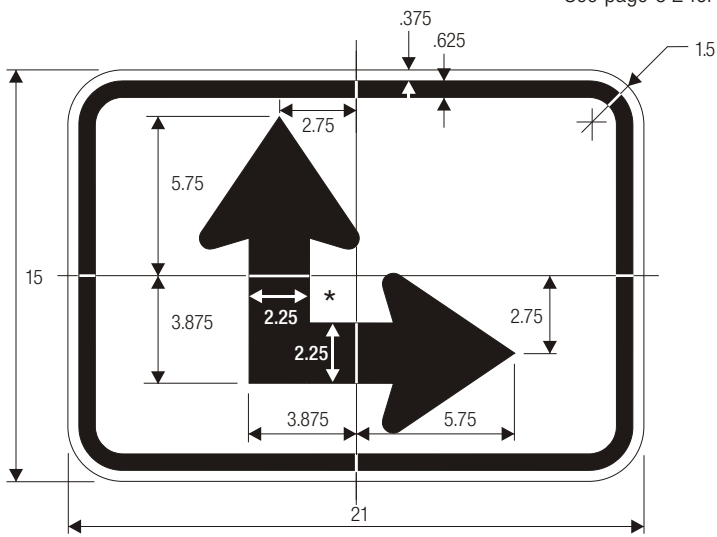

M6-6

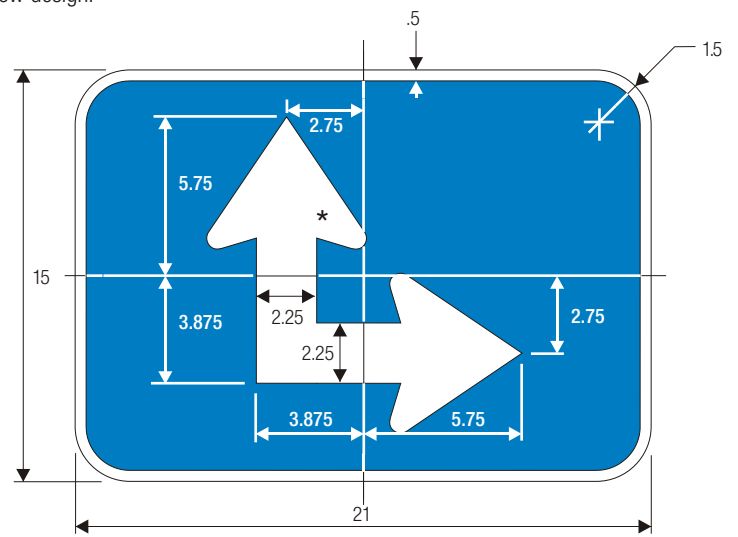

M6-6 (Interstate)

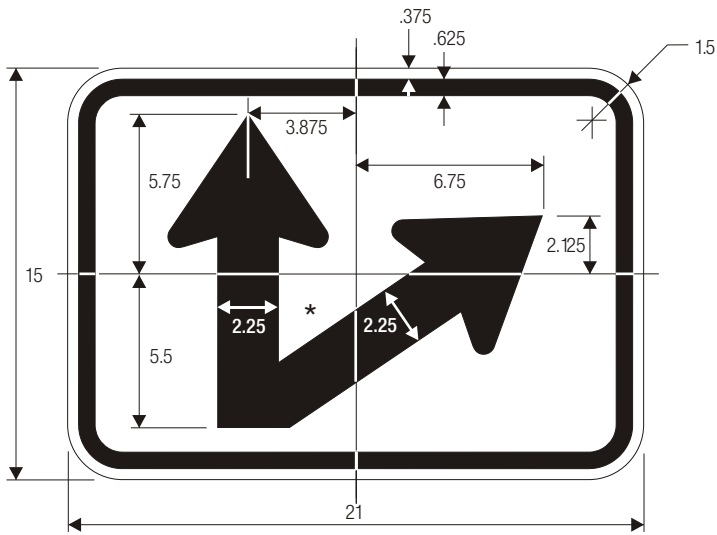

M6-7

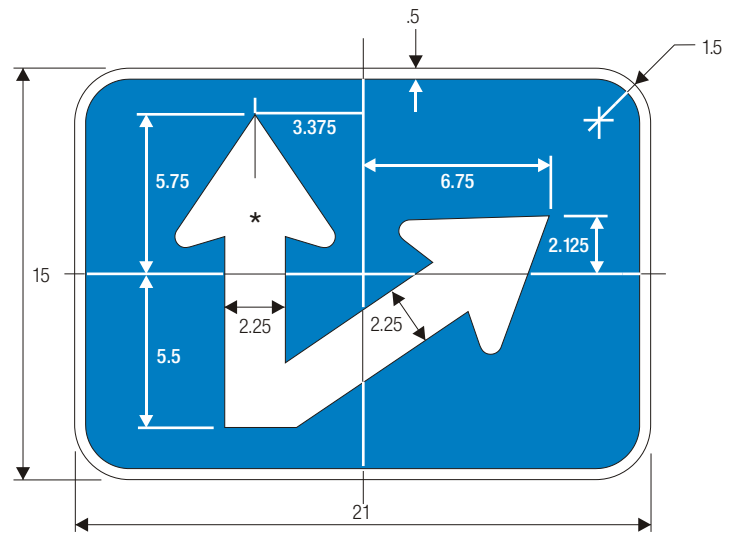

M6-7 (Interstate)

COLORS: LEGEND —BLACK
BACKGROUND —WHITE (RETROREFLECTIVE)

COLORS: LEGEND —WHITE (RETROREFLECTIVE)
BACKGROUND —BLUE (RETROREFLECTIVE)

DIRECTIONAL ARROW AUXILIARY

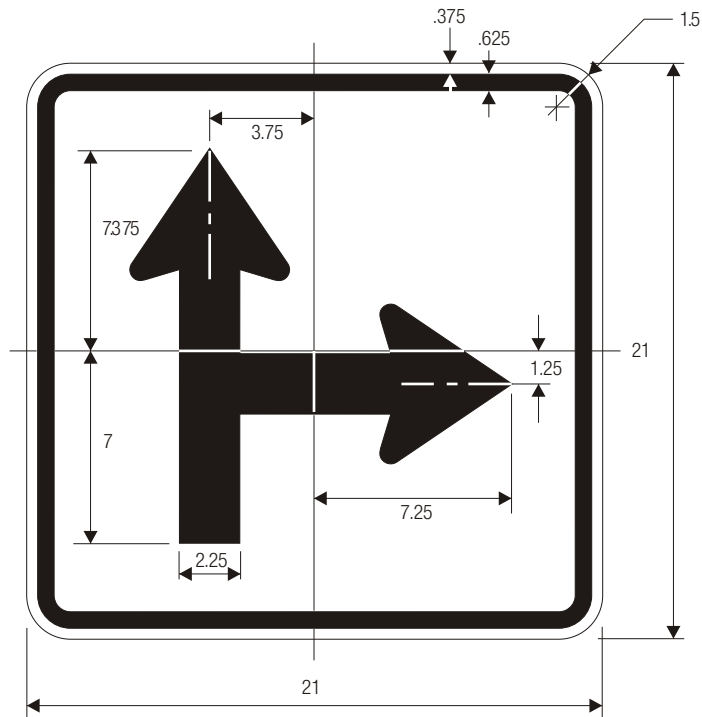

M6-8

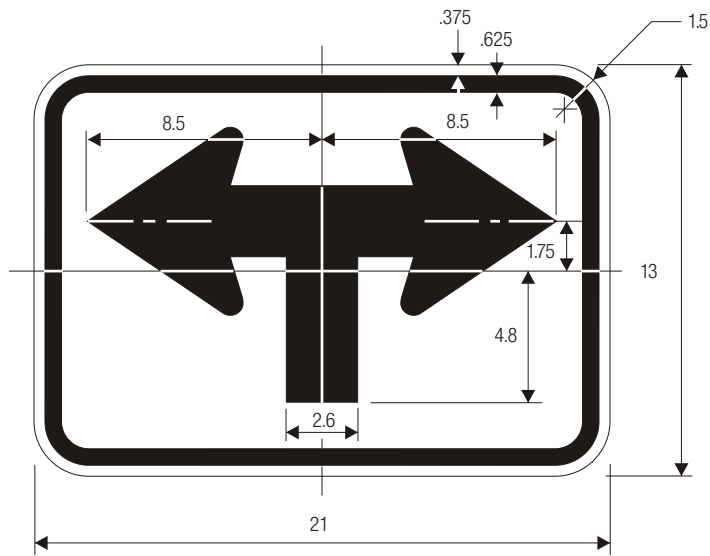

M6-9

*See page 6-2 for arrow design.

COLORS: LEGEND —BLACK
 BACKGROUND —WHITE (RETROREFLECTIVE)

DIRECTIONAL ARROW AUXILIARY
BICYCLE FACILITIES

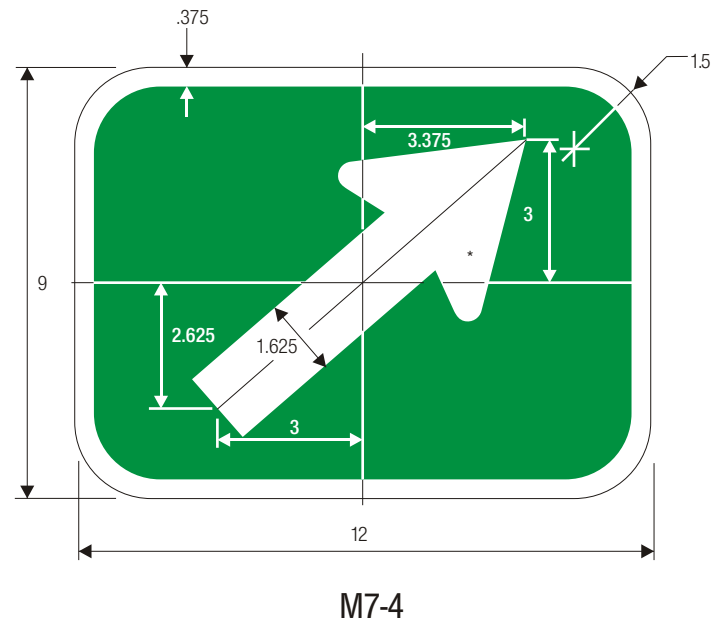
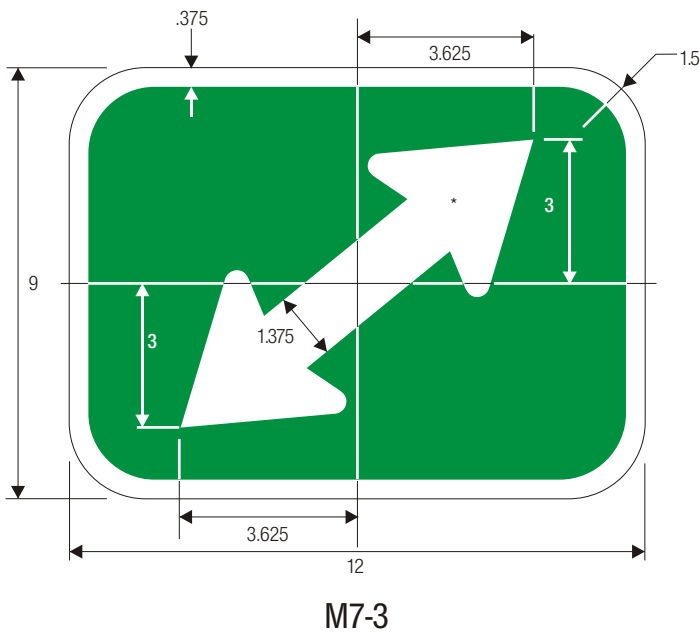
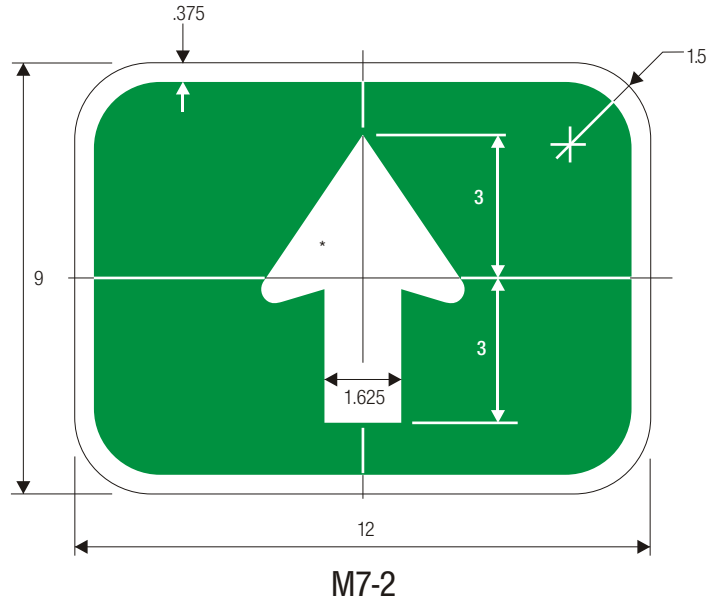
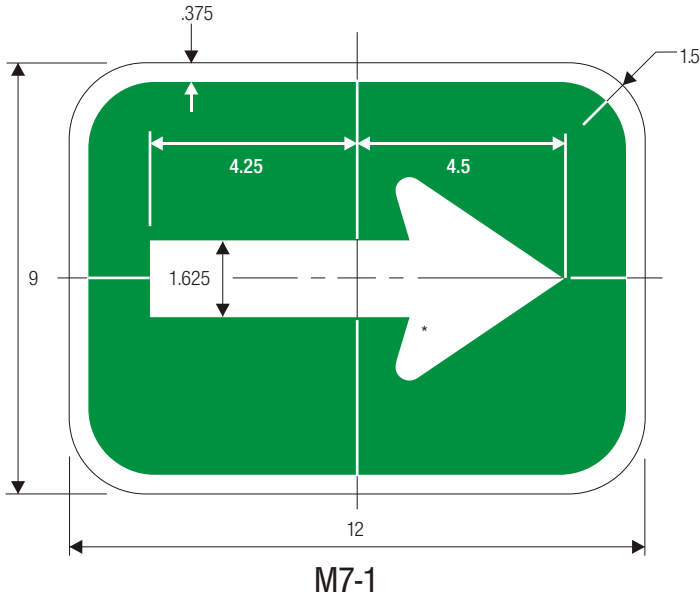

*See page 6-2 for arrow design.

COLORS: SYMBOL —WHITE (RETROREFLECTIVE)
BACKGROUND —GREEN (RETROREFLECTIVE)

DIRECTIONAL ARROW AUXILIARY
BICYCLE FACILITIES

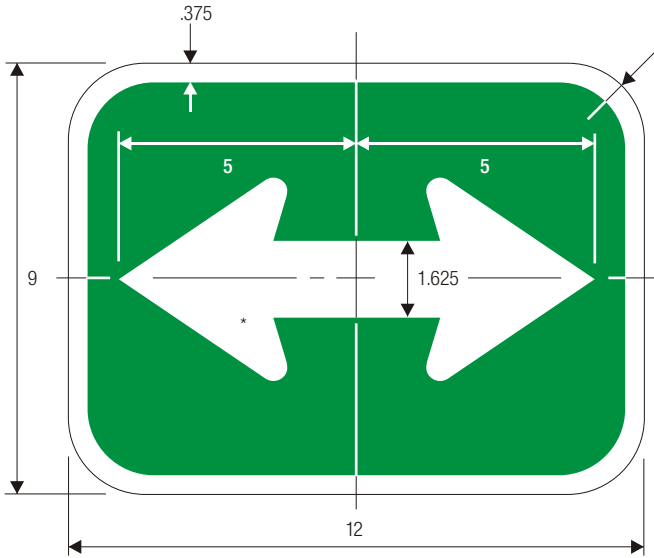

M7-5

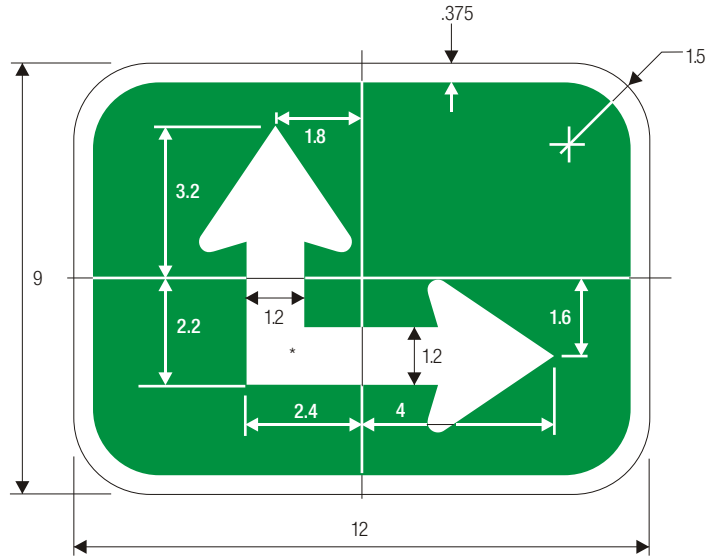

M7-6

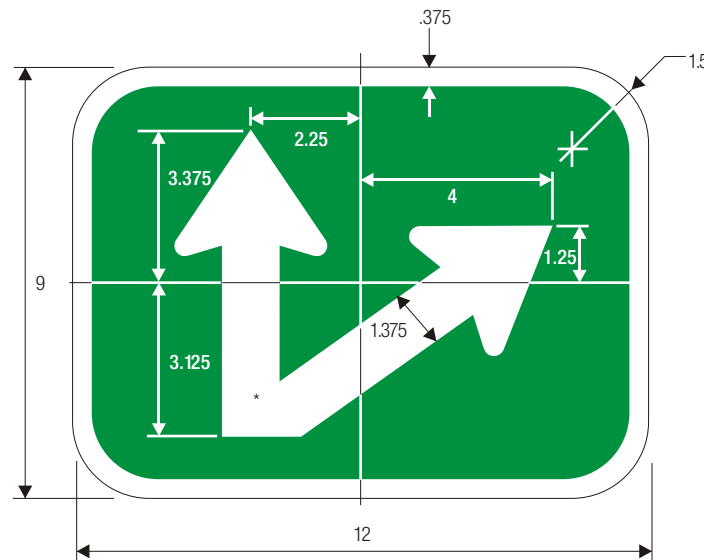

M7-7

*See page 6-2 for arrow design.

COLORS: SYMBOL —WHITE (RETROREFLECTIVE)
BACKGROUND —GREEN (RETROREFLECTIVE)

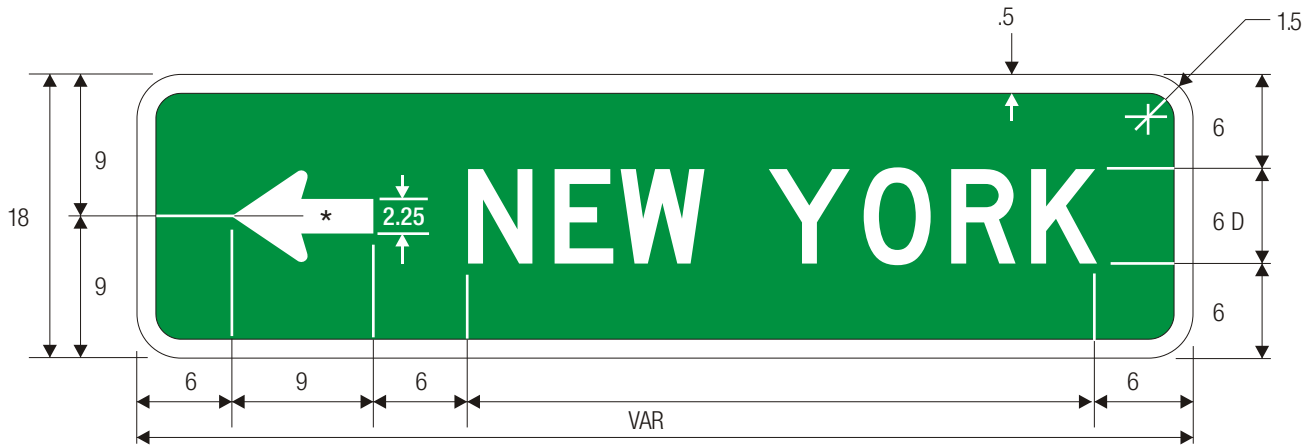

D1-1
DESTINATION



D1-1a
DESTINATION

*See page 6-2 for arrow design.

COLORS: LEGEND -WHITE (RETROREFLECTIVE)
 BACKGROUND -GREEN (RETROREFLECTIVE)



D1-1bL
DESTINATION

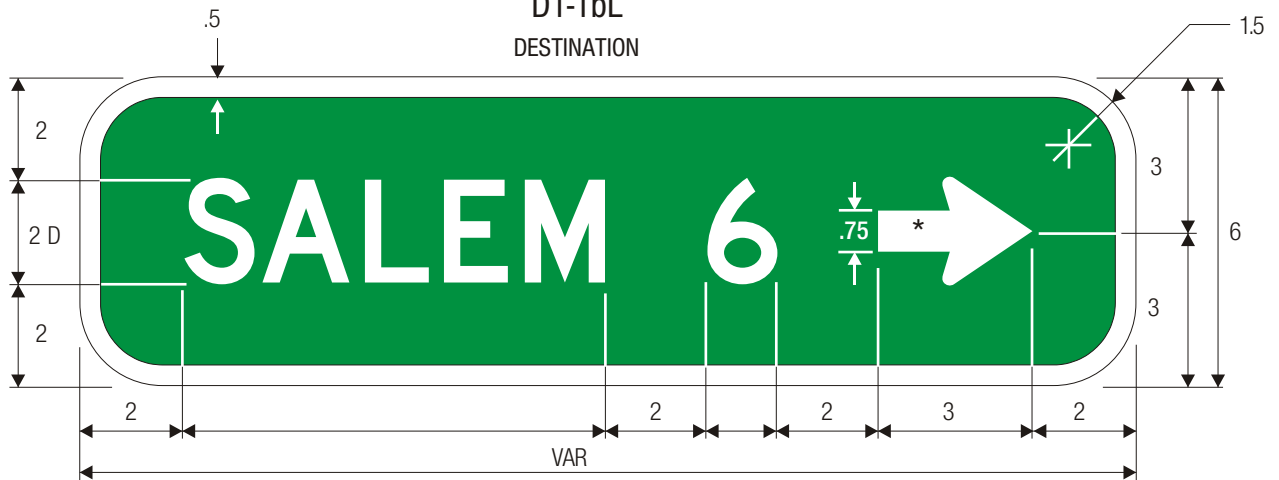

D1-1bR
DESTINATION

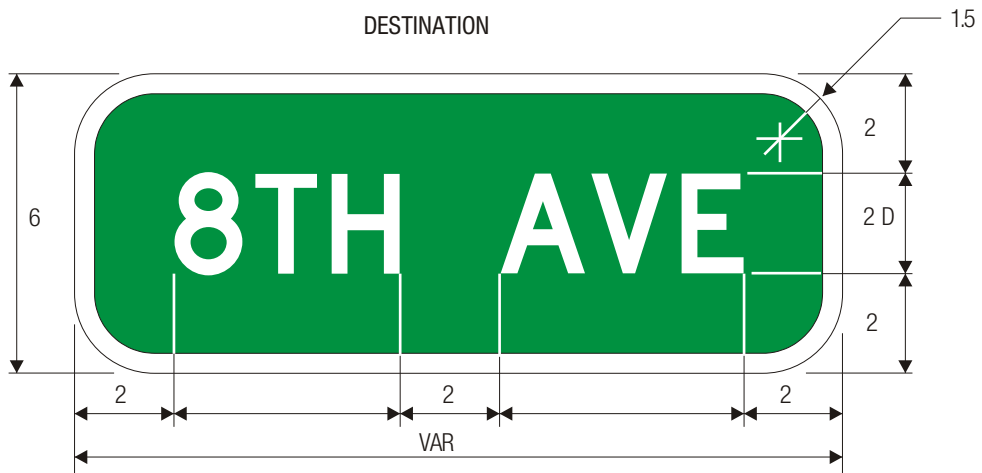

D1-1c
DESTINATION

COLORS: LEGEND -WHITE (RETROREFLECTIVE)
 BACKGROUND -GREEN (RETROREFLECTIVE)



D1-2
DESTINATION



D1-2a
DESTINATION

*See page 6-2 for arrow design

COLORS: LEGEND —WHITE (RETROREFLECTIVE)
BACKGROUND —GREEN (RETROREFLECTIVE)

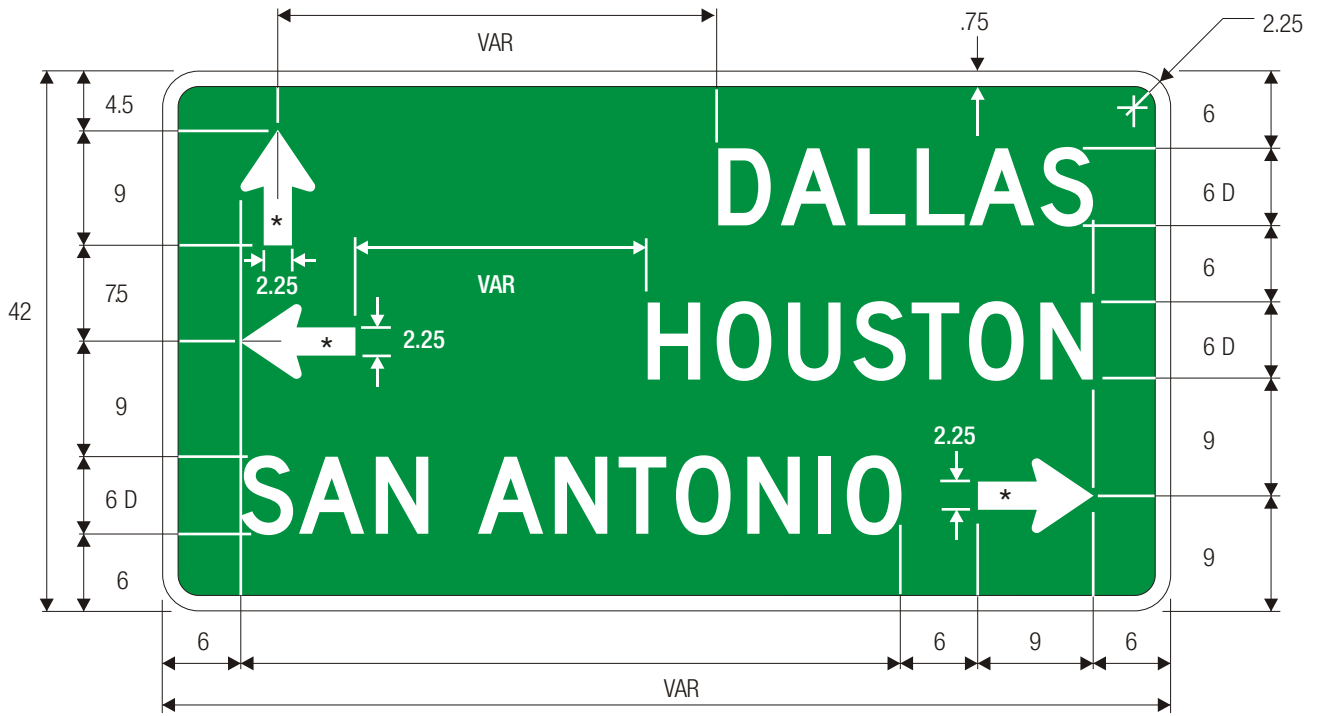

D1-3

DESTINATION

*See page 6-2 for arrow design.



D1-3a

DESTINATION

COLORS: LEGEND -WHITE (RETROREFLECTIVE)
 BACKGROUND -GREEN (RETROREFLECTIVE)

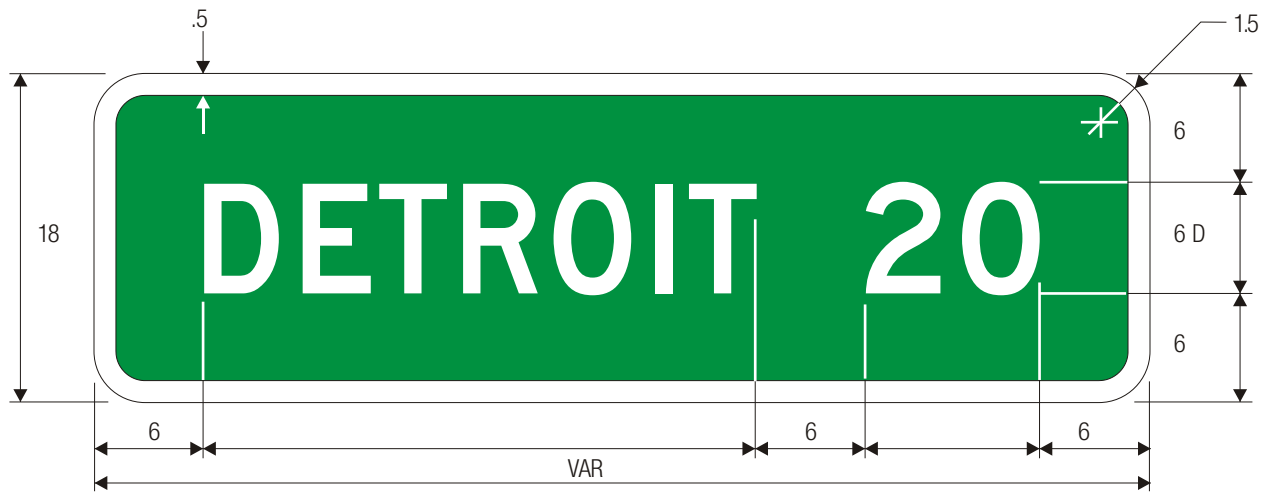

D2-1 DISTANCE



D2-2 DISTANCE



D2-3 DISTANCE

COLORS: LEGEND —WHITE (RETROREFLECTIVE)
 BACKGROUND —GREEN (RETROREFLECTIVE)



D-3
STREET NAME



D-3
STREET NAME

COLORS: LEGEND -WHITE (REFLECTIVE)
BACKGROUND -GREEN (REFLECTIVE)



D4-1
PARKING AREA

*See page 6-2 for arrow design.

COLORS: LEGEND -WHITE (RETROREFLECTIVE)
BACKGROUND -GREEN (RETROREFLECTIVE)

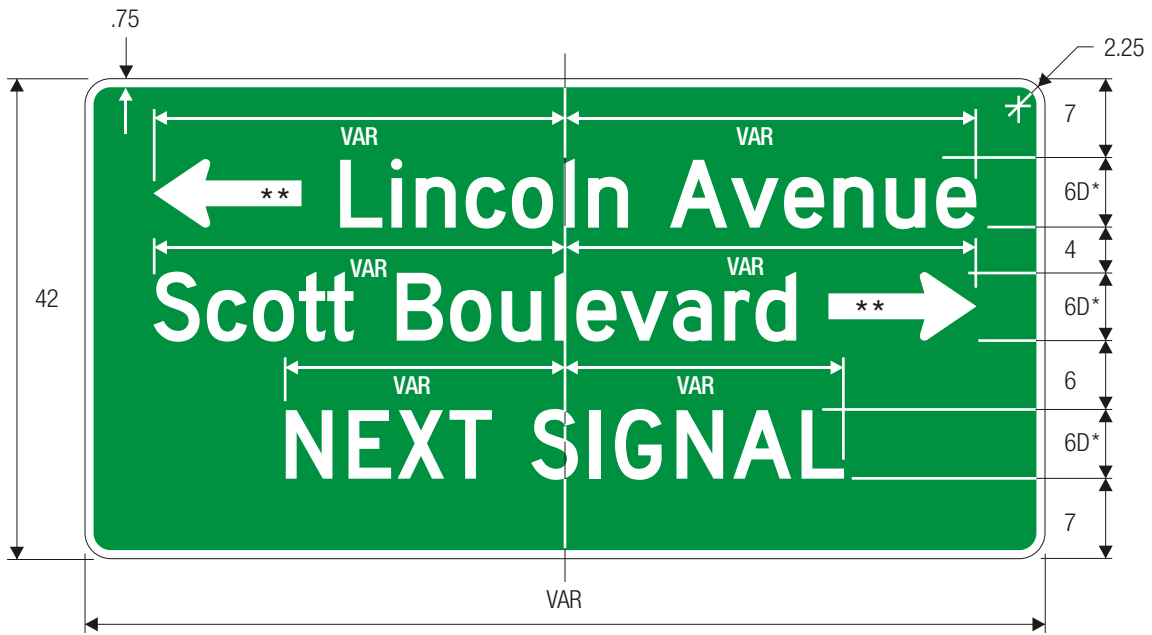

D3-2

ADVANCE STREET NAME

**See page 6-2 for arrow design.

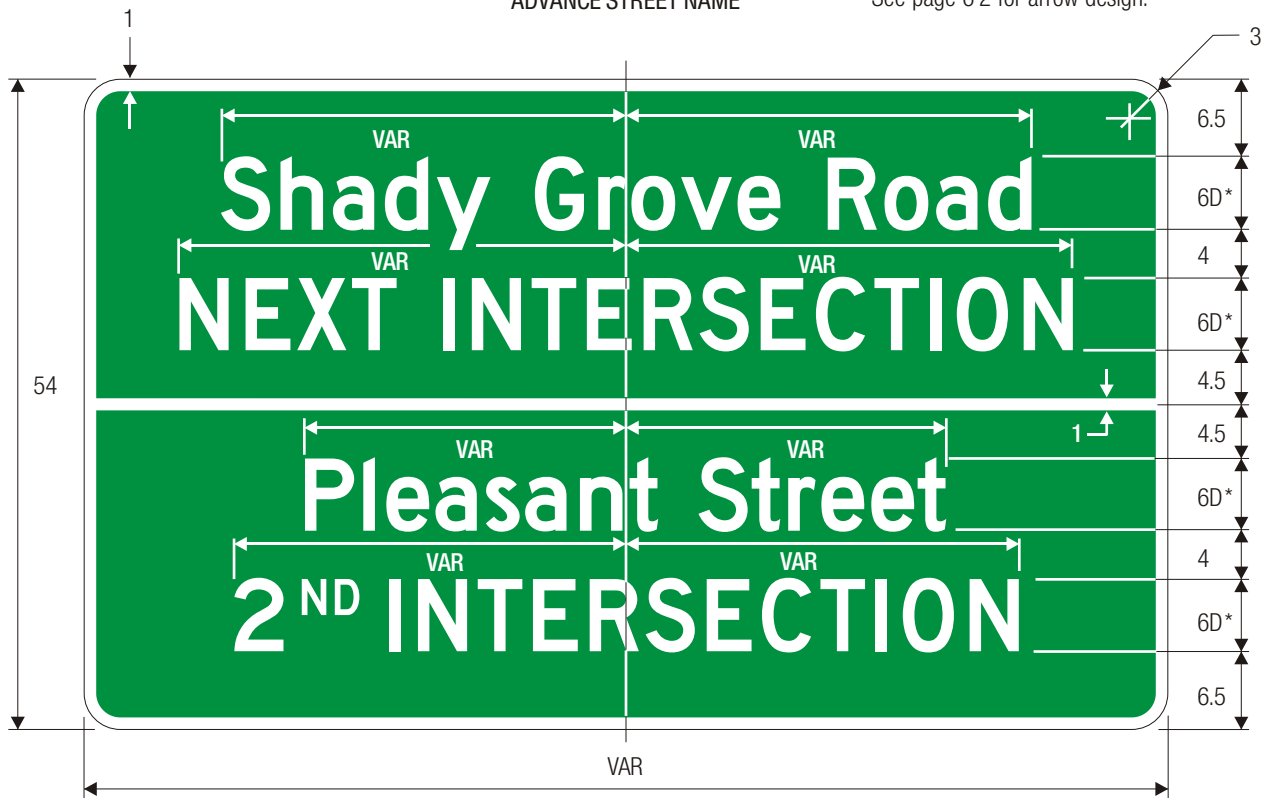

*Series 2000 Standard Alphabets.

COLORS: LEGEND —WHITE (RETROREFLECTIVE)
 BACKGROUND —GREEN (RETROREFLECTIVE)

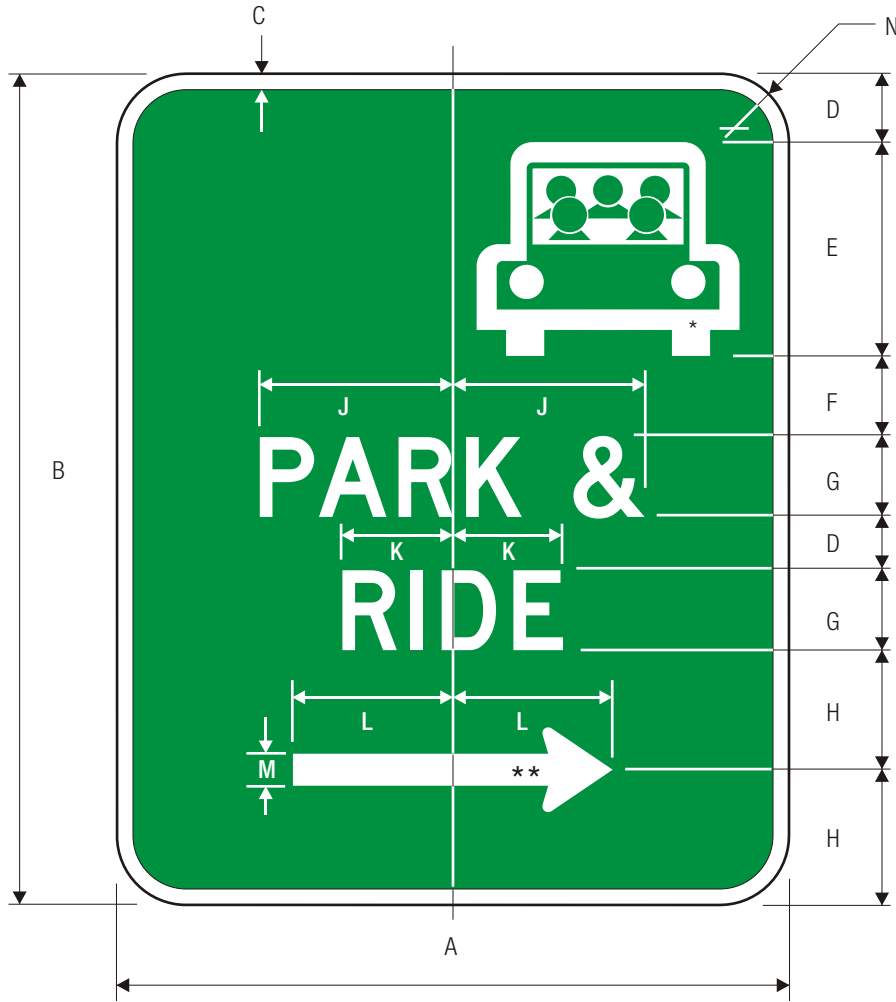

D4-2

PARK & RIDE

**See page 6-2 for arrow design.

*See symbol on page 6-42

A	B	C	D	E	F	G	H	J	K	L	M	N
24	30	.625	2	8	3	3 D	4.5	8	5	6	1.125	1.5
30	36	.75	3	9	3	4 D	5	11	6	7	1.5	1.875
36	48	.875	4	11	3	6 D	7	14	8	9	2.25	2.25

COLORS: LEGEND —WHITE (RETROREFLECTIVE)
 BACKGROUND —GREEN (RETROREFLECTIVE)
 SYMBOL —GREEN ON WHITE (RETROREFLECTIVE)



D4-3

BICYCLE PARKING

*See page 6-7 for symbol design.

**See page 6-2 for arrow design.

COLORS: LEGEND & SYMBOL — GREEN (RETROREFLECTIVE)
 BACKGROUND — WHITE (RETROREFLECTIVE)

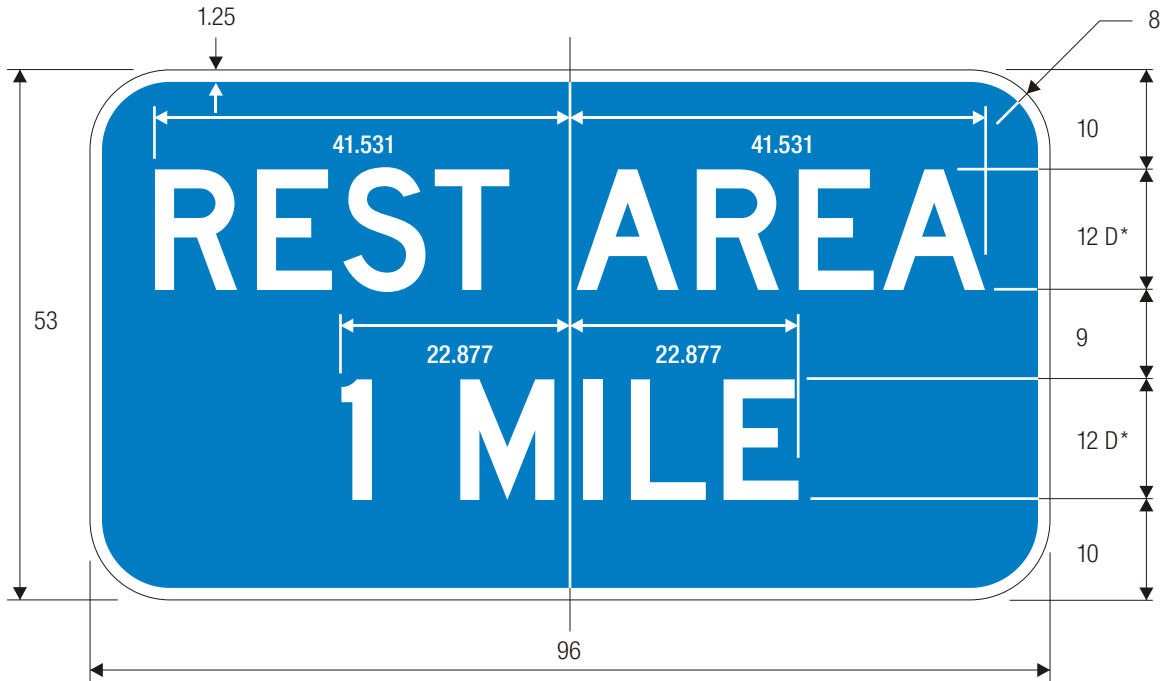

D5-1

ADVANCE REST AREA DISTANCE

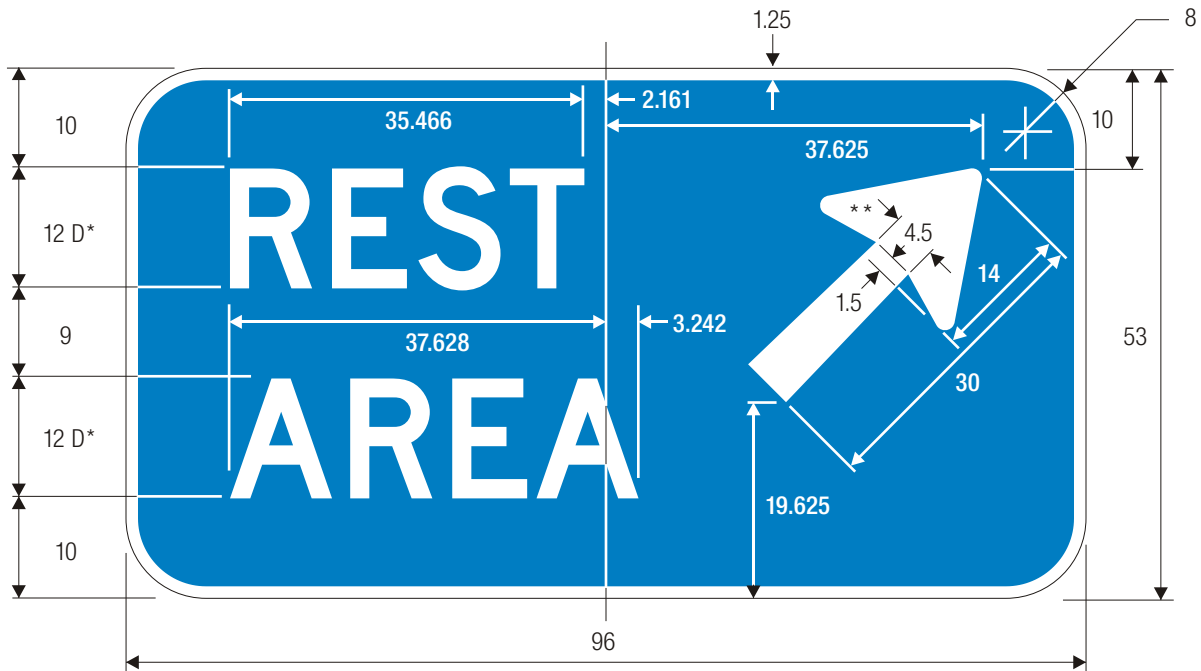

D5-2

REST AREA EXIT DIRECTION

*Series 2000 Standard Alphabets.
 **See page 6-3 for symbol design.

COLORS: LEGEND & ARROW – WHITE (RETROREFLECTIVE)
 BACKGROUND – BLUE (RETROREFLECTIVE)

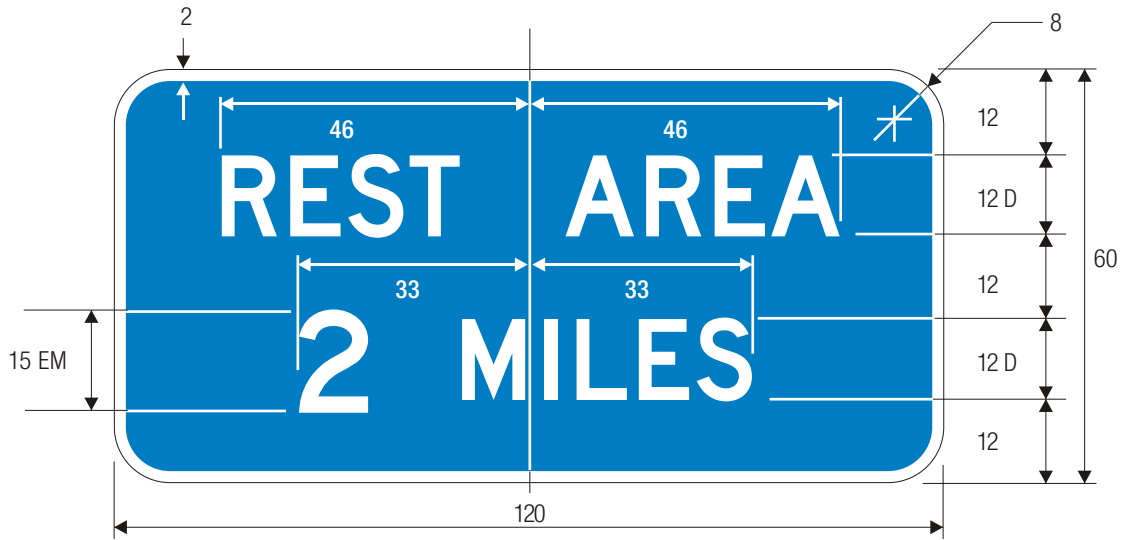

D5-1a

COLORS: LEGEND — WHITE (RETROREFLECTIVE)
 BACKGROUND— BLUE (RETROREFLECTIVE)

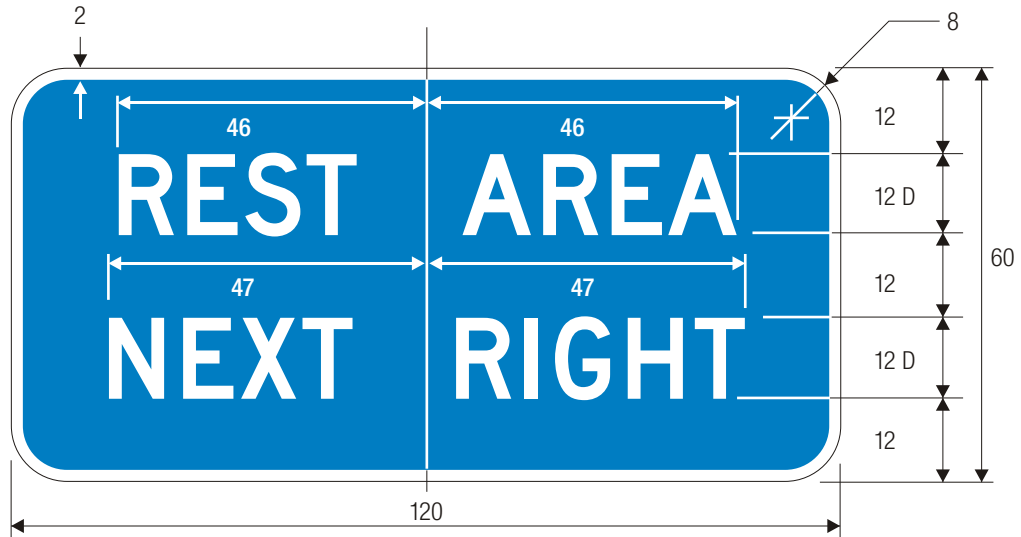

D5-1b

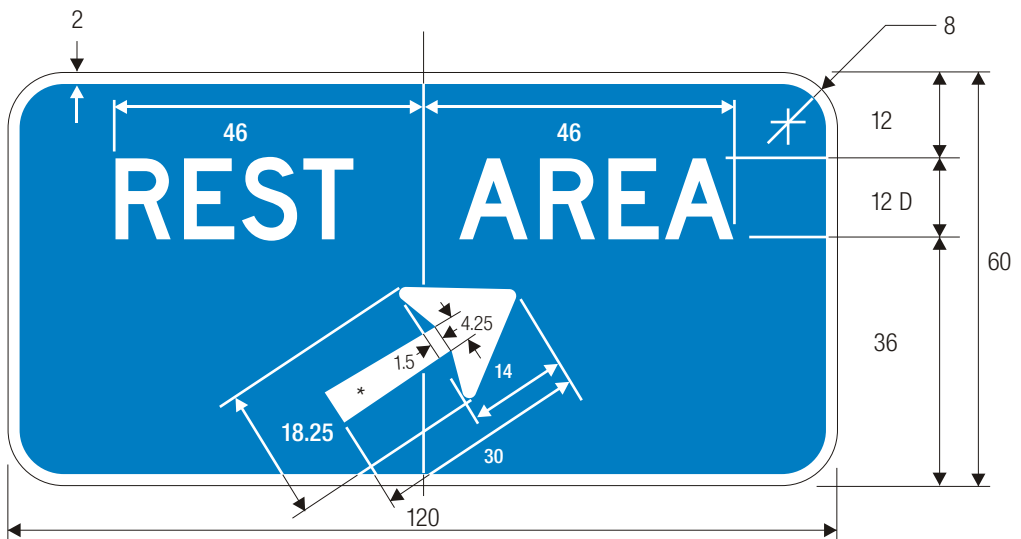

D5-2a

*See page 6-3 for arrow design details.

COLORS: LEGEND — WHITE (RETROREFLECTIVE)
 BACKGROUND — BLUE (RETROREFLECTIVE)

REST AREA GORE SIGN

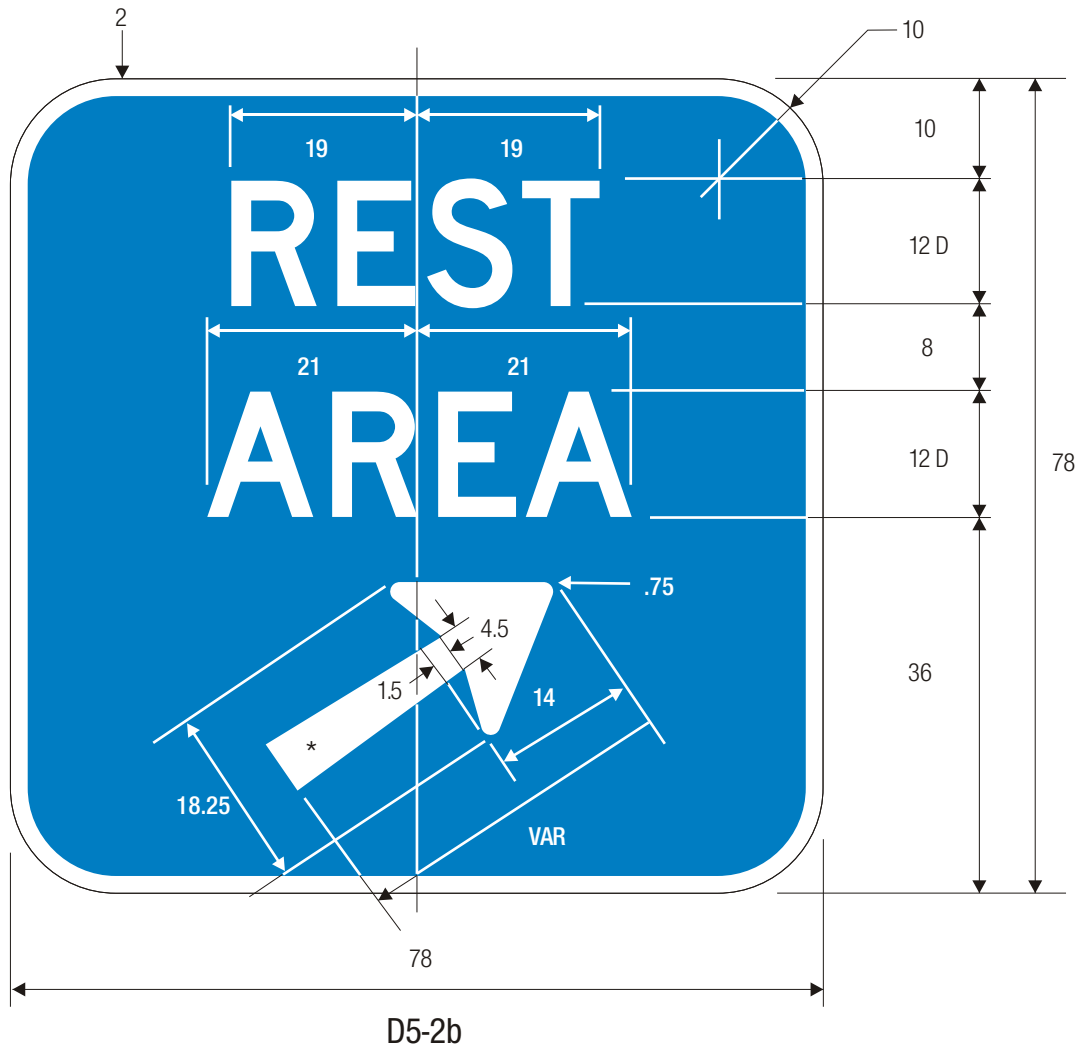

*Optically center arrow
(see page 6-3 for arrow design details)

COLORS: LEGEND — WHITE (RETROREFLECTIVE)
BACKGROUND— BLUE (RETROREFLECTIVE)

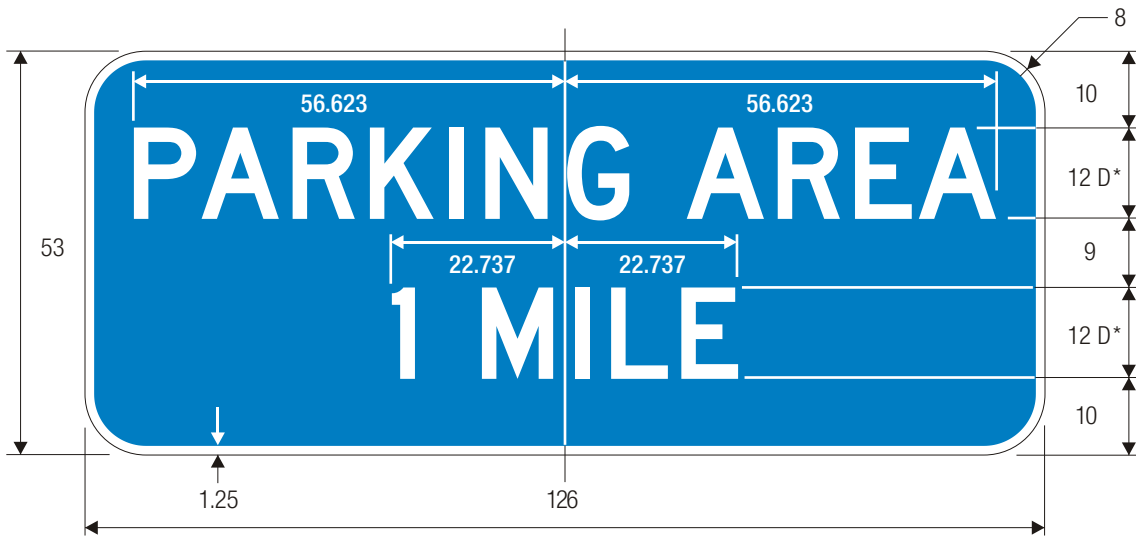

D5-3
ADVANCE PARKING AREA DISTANCE

*Series 2000 Standard Alphabets.

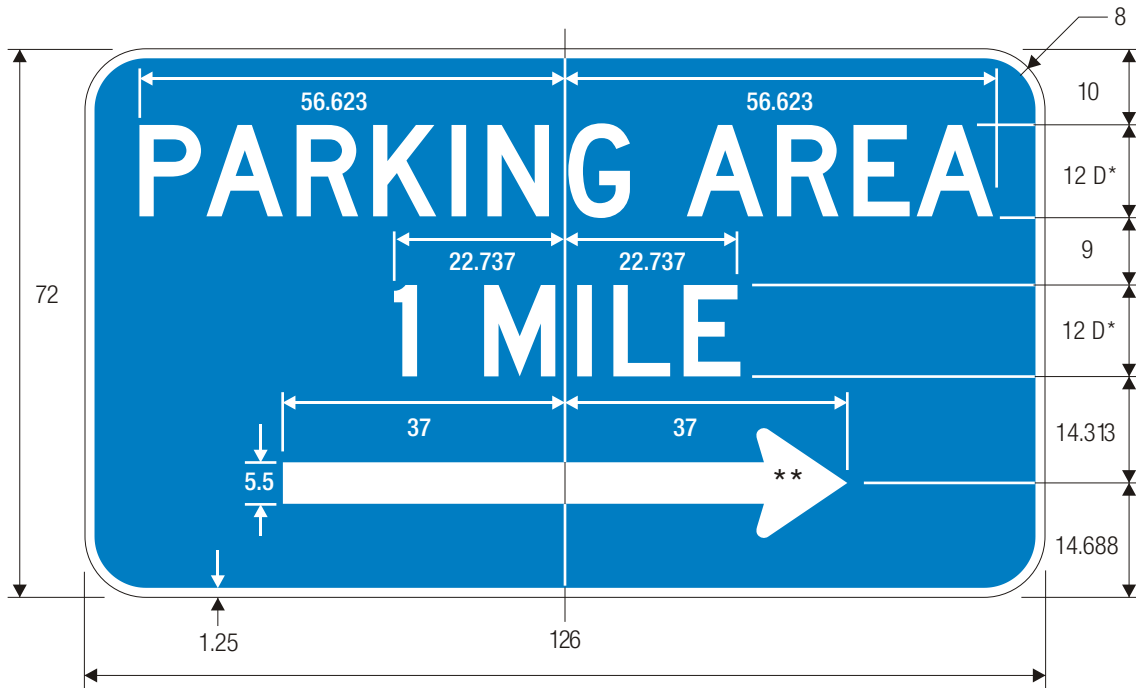

D5-3c
PARKING AREA ARROW & DISTANCE

**See page 6-2 for arrow design.

COLORS: LEGEND & ARROW – WHITE (RETROREFLECTIVE)
BACKGROUND – BLUE (RETROREFLECTIVE)

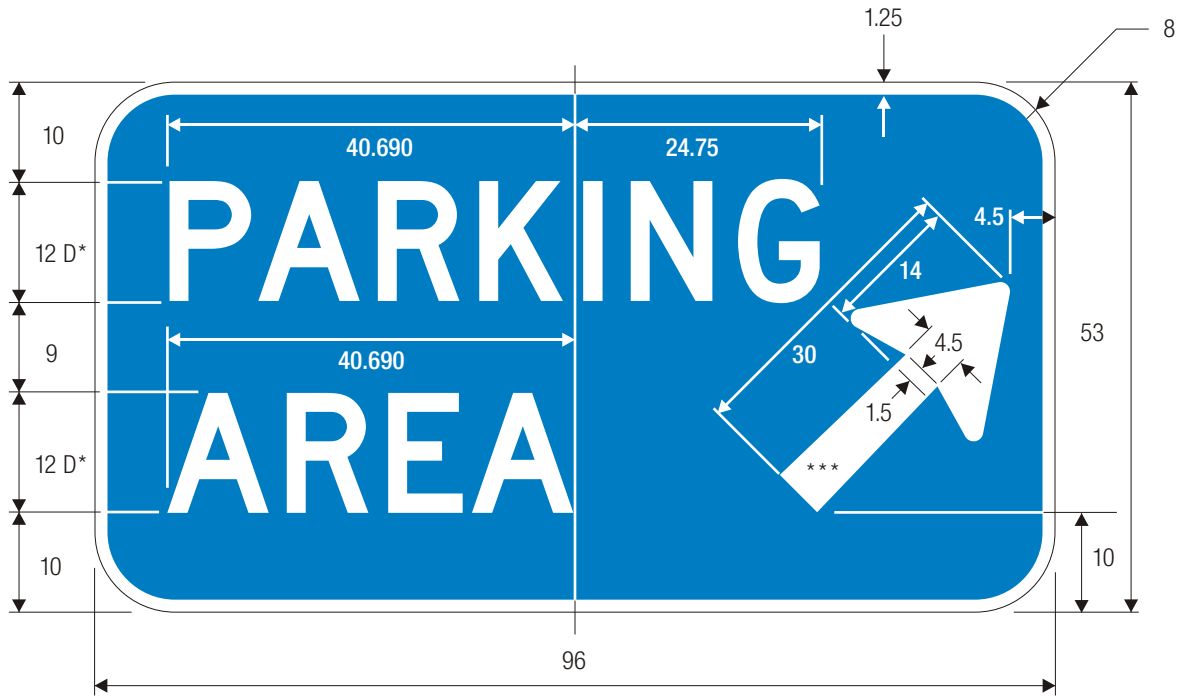

D5-4

PARKING AREA EXIT DIRECTION

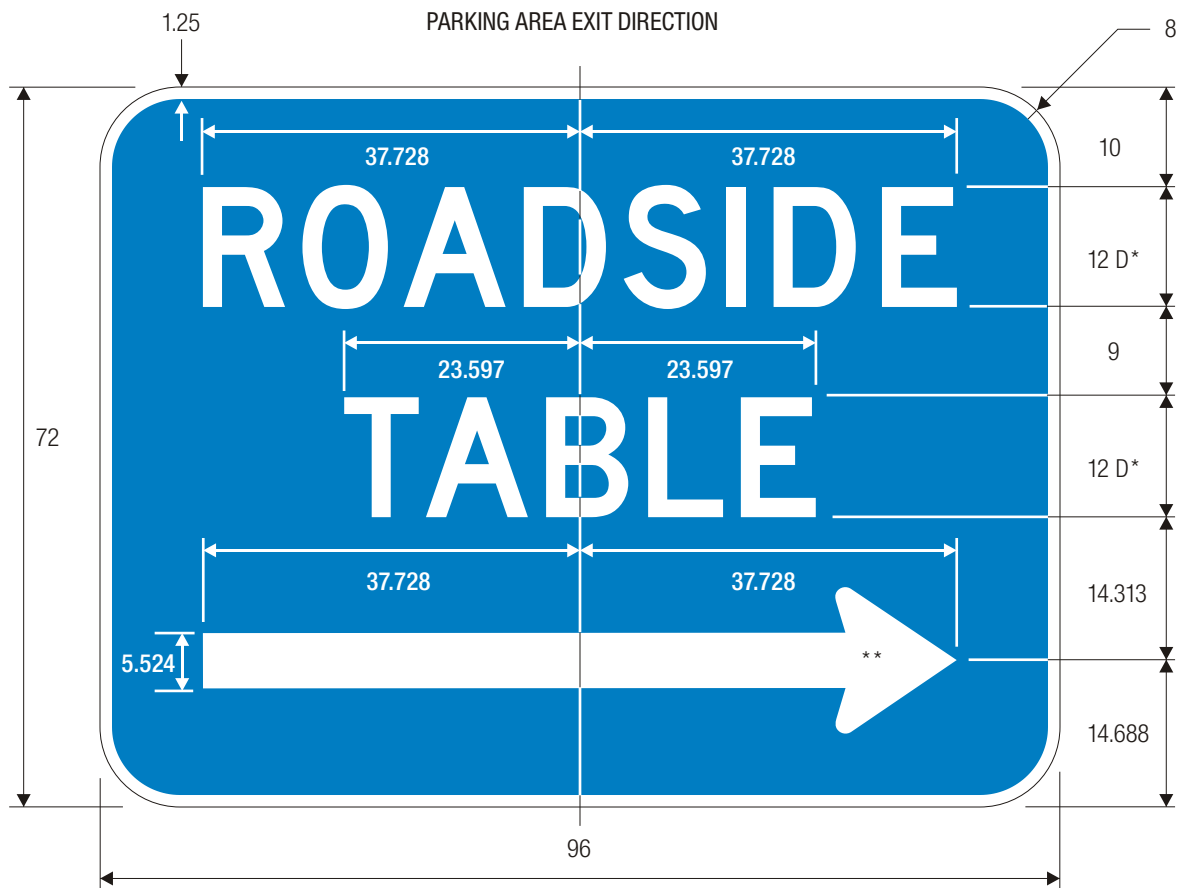

D5-5

ROADSIDE TABLE ARROW

*Series 2000 Standard Alphabets.
 **See page 6-2 for symbol design.
 ***See page 6-3 for symbol design.

COLORS: LEGEND & ARROW – WHITE (RETROREFLECTIVE)
 BACKGROUND – BLUE (RETROREFLECTIVE)

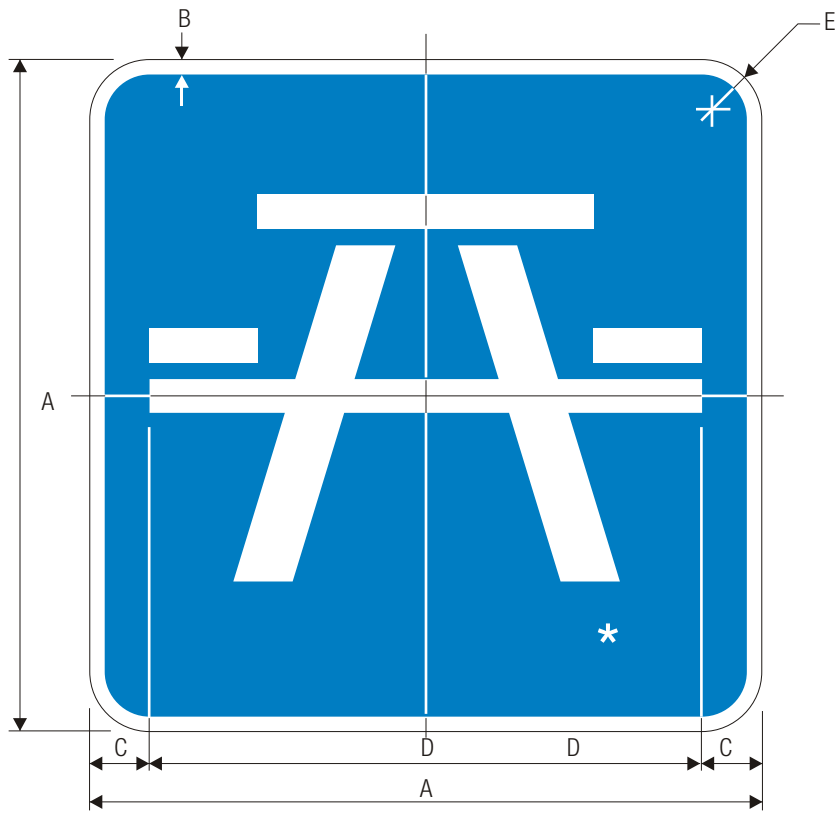

D5-5a

ROADSIDE TABLE SYMBOL

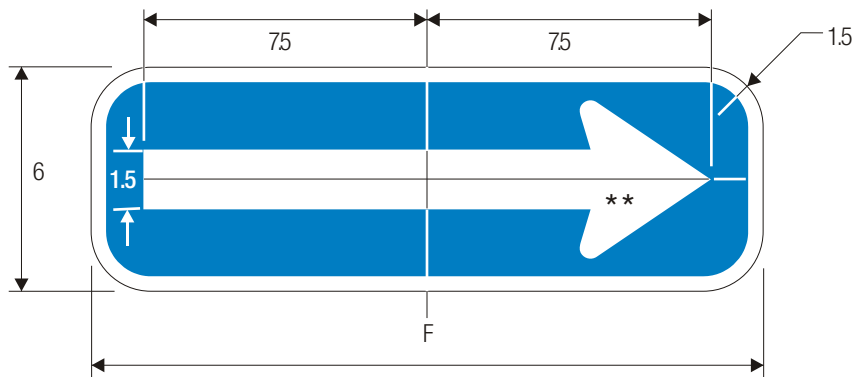

*See page 6-43 for symbol design.

**See page 6-2 for arrow design.

A	B	C	D	E	F
18	.5	1.5	15	1.5	18
24	.5	2	20	1.5	24
30	.75	2.5	25	1.875	24

COLORS: SYMBOL WHITE (RETROREFLECTIVE)
 BACKGROUND BLUE (RETROREFLECTIVE)

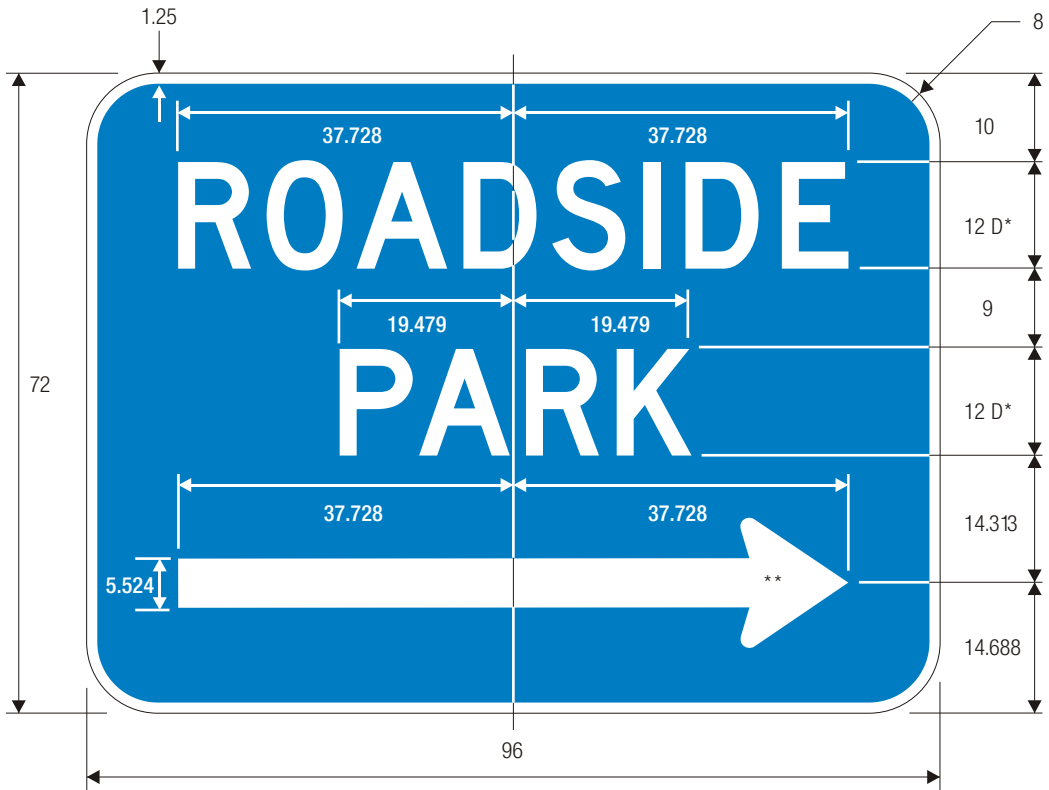

D5-5b

ROADSIDE PARK ARROW

*Series 2000 Standard Alphabets.
 **See page 6-2 for symbol design.

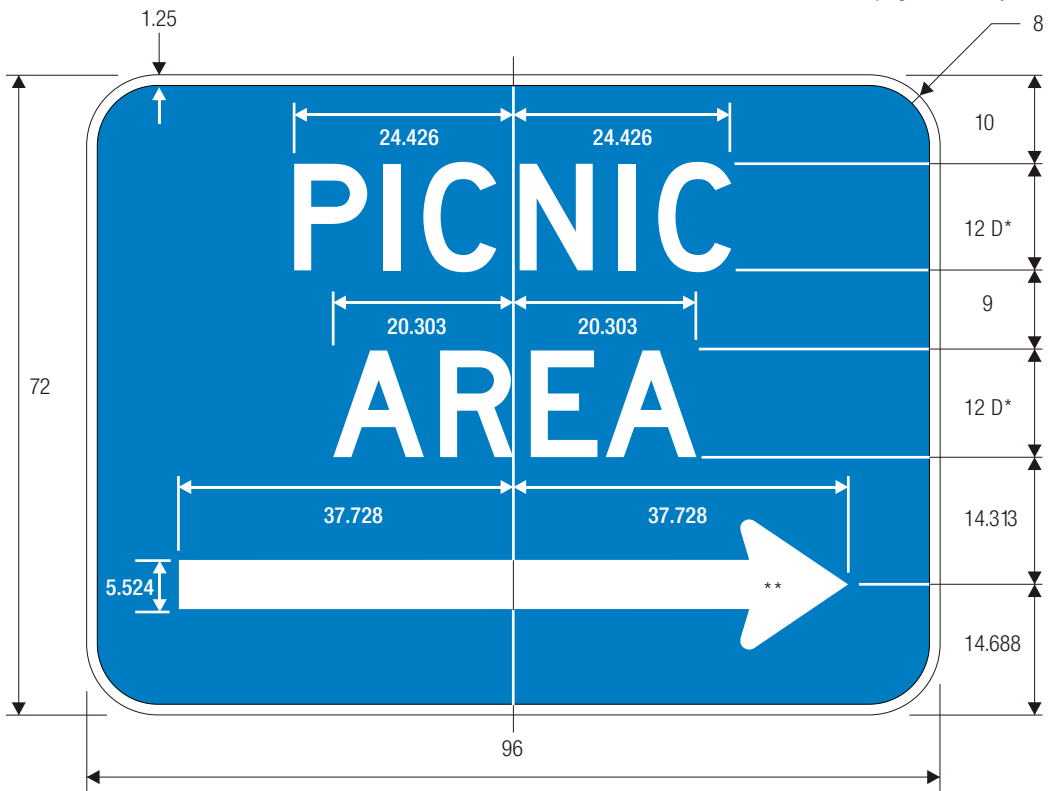

D5-5c

PICNIC AREA

COLORS: LEGEND & ARROW – WHITE (RETROREFLECTIVE)
 BACKGROUND – BLUE (RETROREFLECTIVE)



D5-5d

ROADSIDE PARK DISTANCE

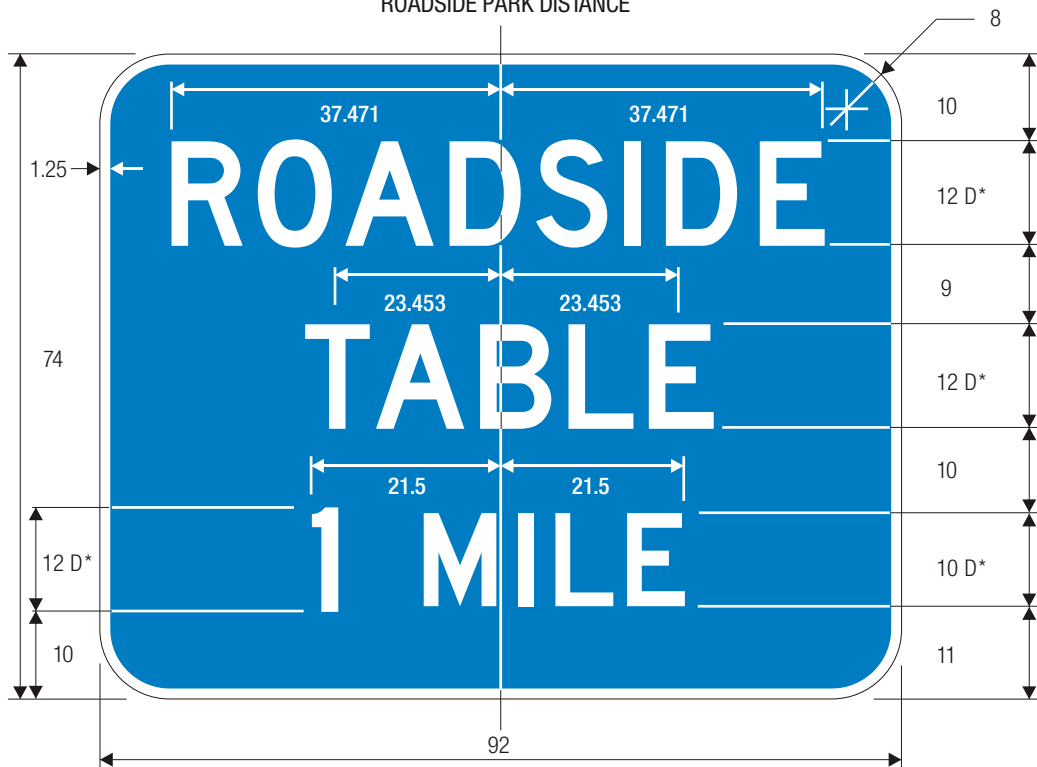

D5-5e

ROADSIDE TABLE DISTANCE

*Series 2000 Standard Alphabets.

COLORS: LEGEND & ARROW – WHITE (RETROREFLECTIVE)
 BACKGROUND – BLUE (RETROREFLECTIVE)

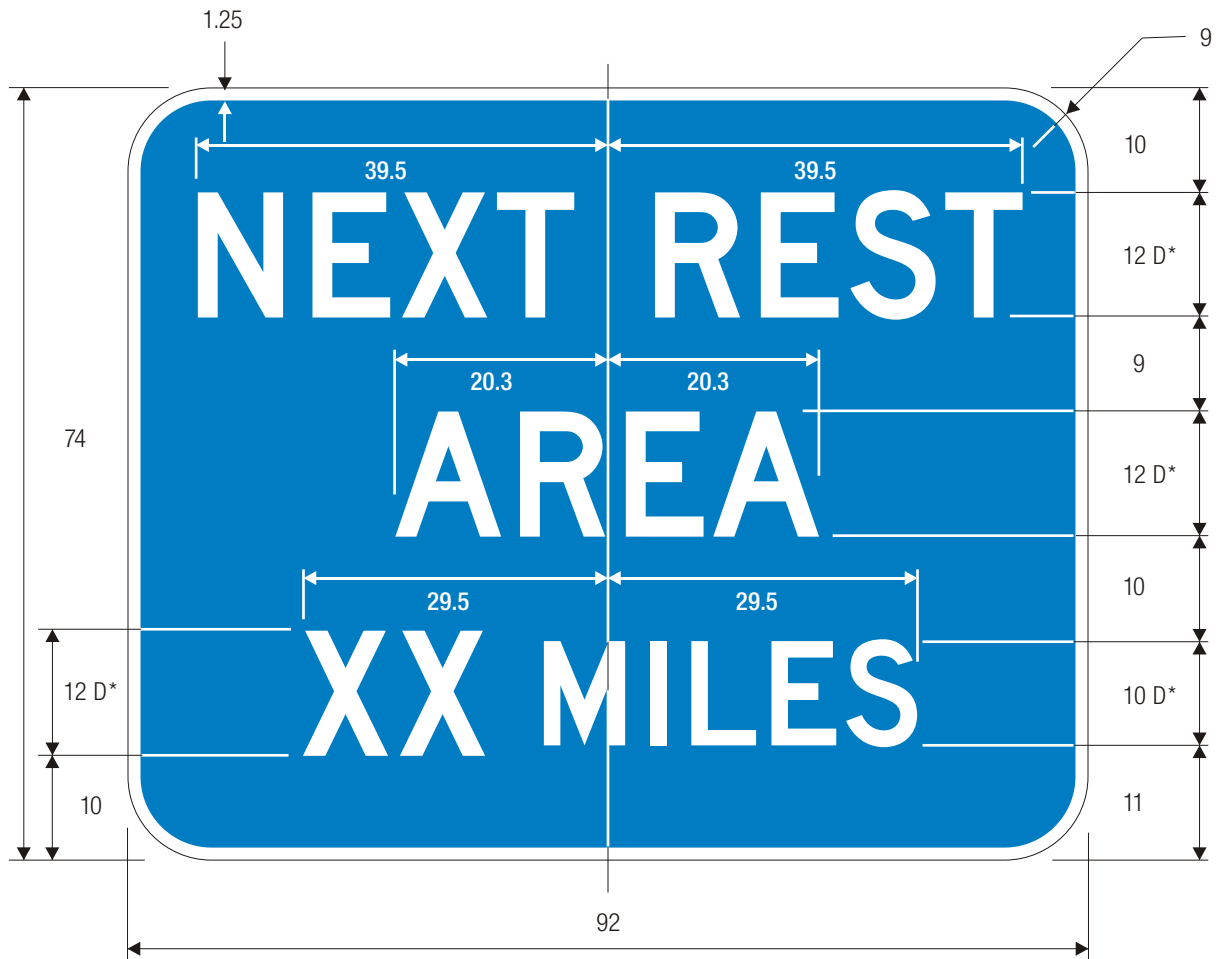

D5-6

NEXT REST AREA (XX MILES)

COLORS: LEGEND & ARROW – WHITE (RETROREFLECTIVE)
 BACKGROUND – BLUE (RETROREFLECTIVE)

ADVANCE REST AREA—TOURIST
INFORMATION CENTER SIGN

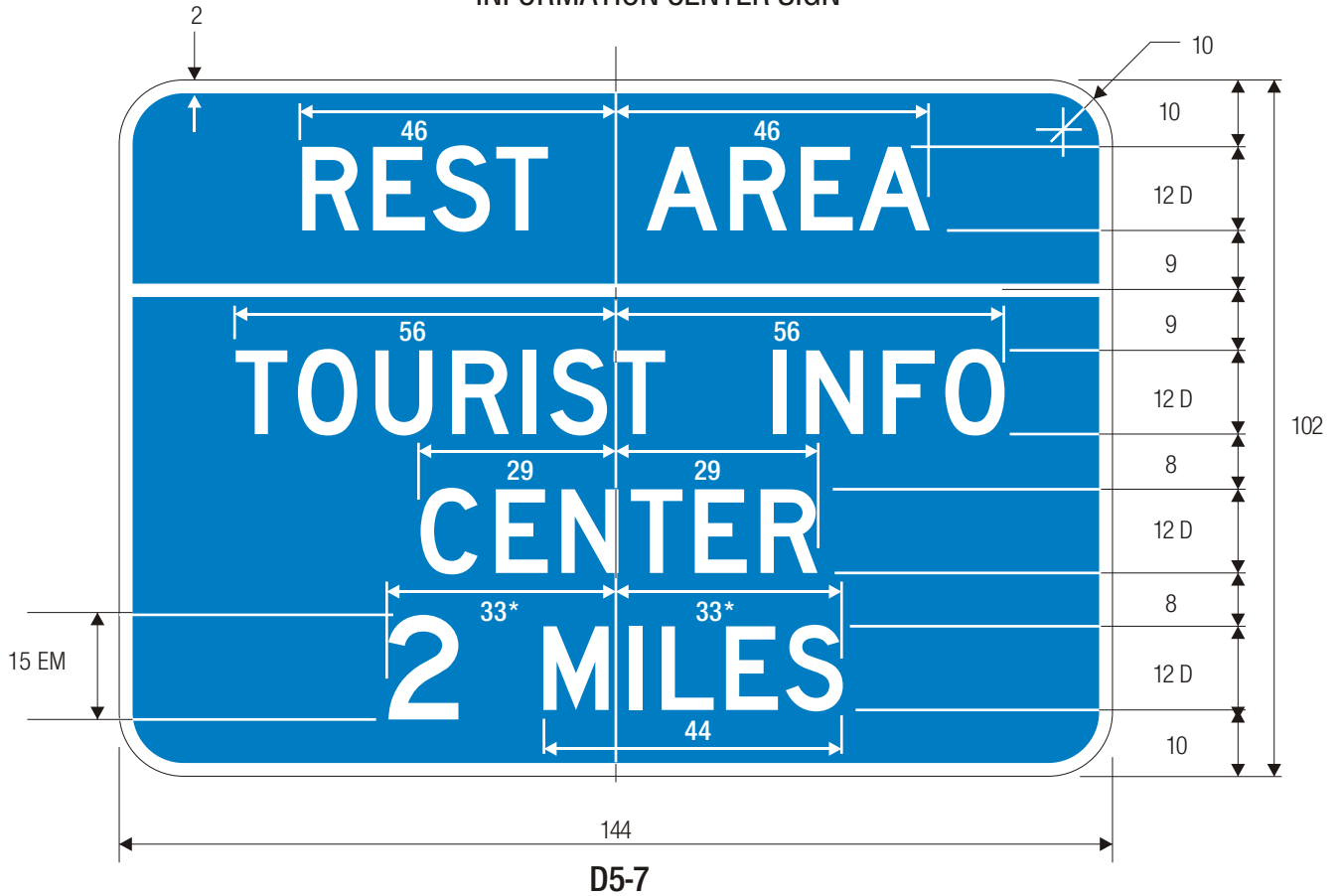

*OPTICALLY CENTER OTHER DISTANCES

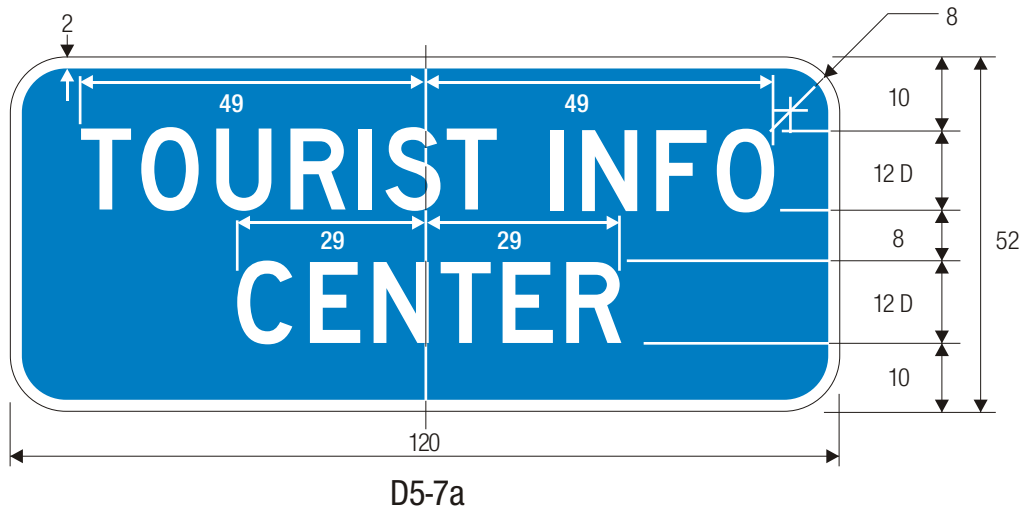

COLORS: LEGEND — WHITE (RETROREFLECTIVE)
BACKGROUND— BLUE (RETROREFLECTIVE)

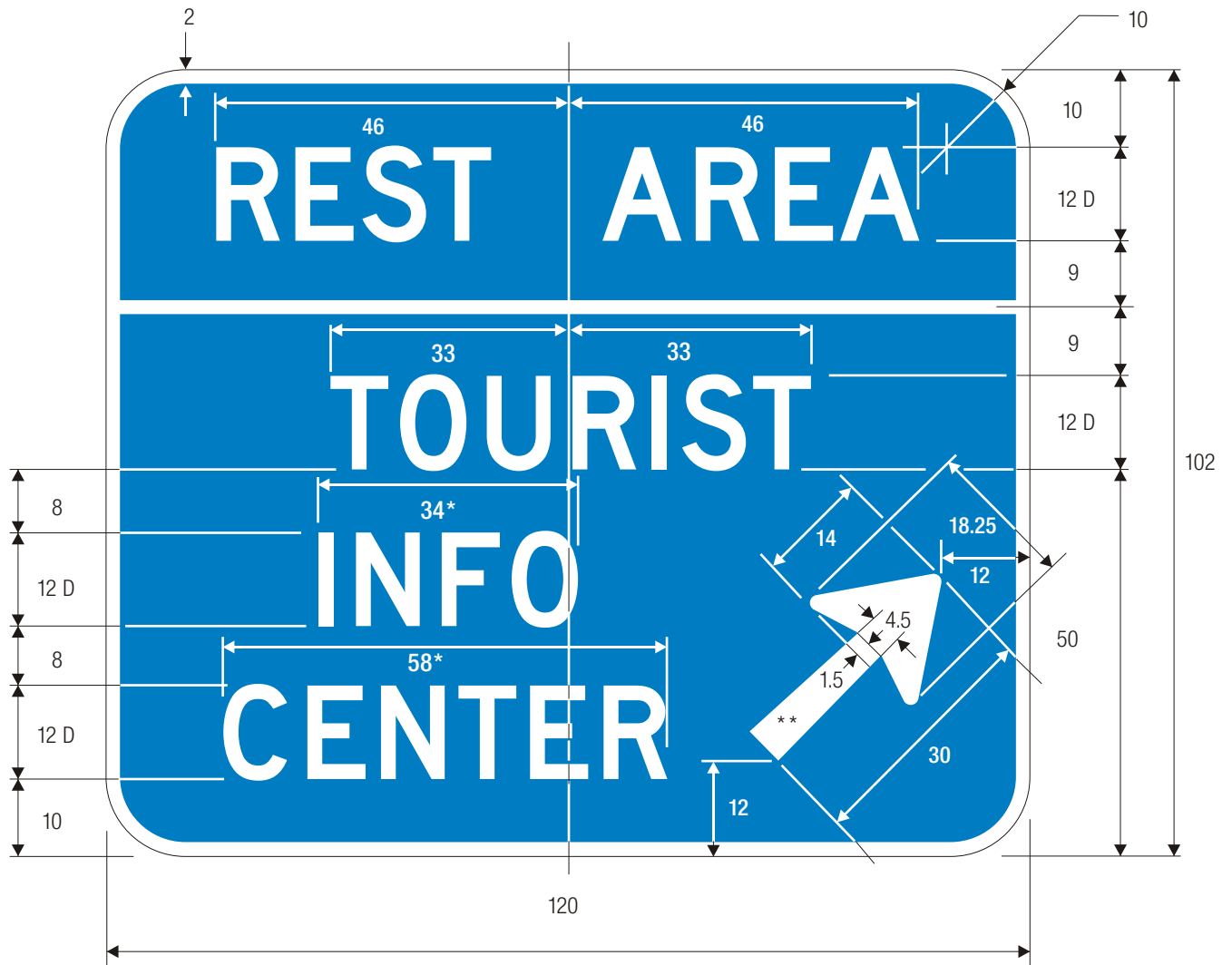

D5-8

COMBINATION REST AREA
 TOURIST INFO CENTER
 EXIT DIRECTION

*Optically center legend

**See page 6-3 for arrow design details

COLORS: LEGEND — WHITE (RETROREFLECTIVE)
 BACKGROUND — BLUE (RETROREFLECTIVE)

Advance Rest-Welcome Sign



D5-9

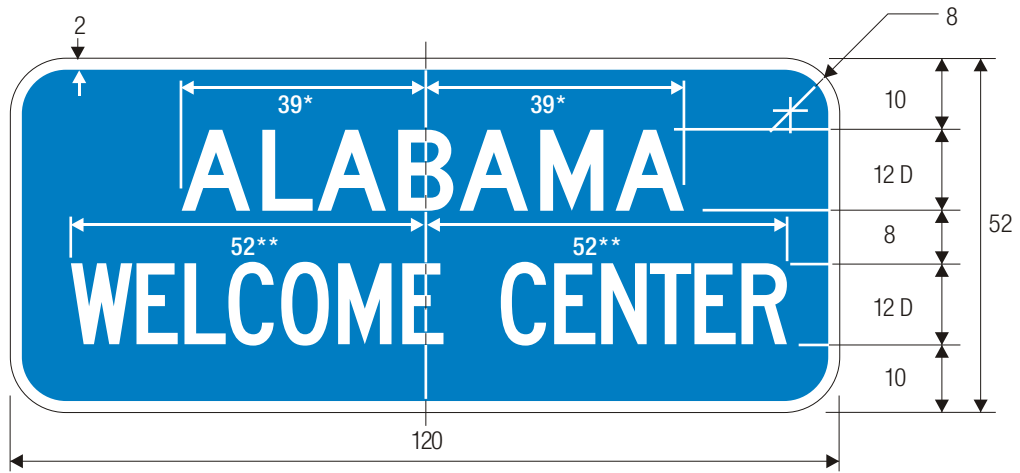

D5-9a

*Optically center other State names
 **Reduce spacing to fit

COLORS: LEGEND — WHITE (RETROREFLECTIVE)
 BACKGROUND— BLUE (RETROREFLECTIVE)



COMBINATION REST AREA
STATE WELCOME CENTER
EXIT DIRECTION

*Optically center legend
**See page 6-3 for arrow design details

COLORS: LEGEND — WHITE (RETROREFLECTIVE)
BACKGROUND — BLUE (RETROREFLECTIVE)

EXIT DIRECTION REST AREA-WELCOME
CENTER SIGN (ALTERNATE)

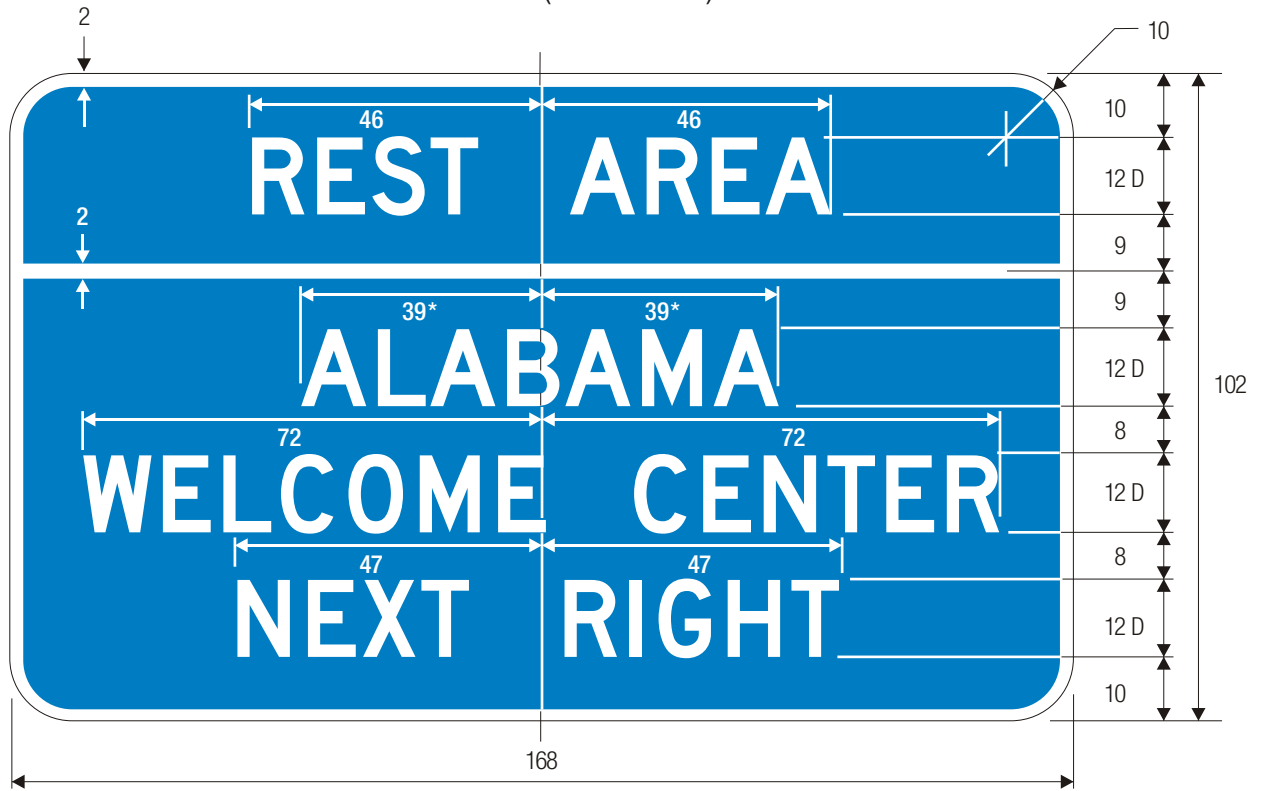

D5-11

*Optically center other State names

COMBINATION REST AREA
STATE WELCOME CENTER
NEXT RIGHT

COLORS: LEGEND — WHITE (RETROREFLECTIVE)
BACKGROUND— BLUE (RETROREFLECTIVE)

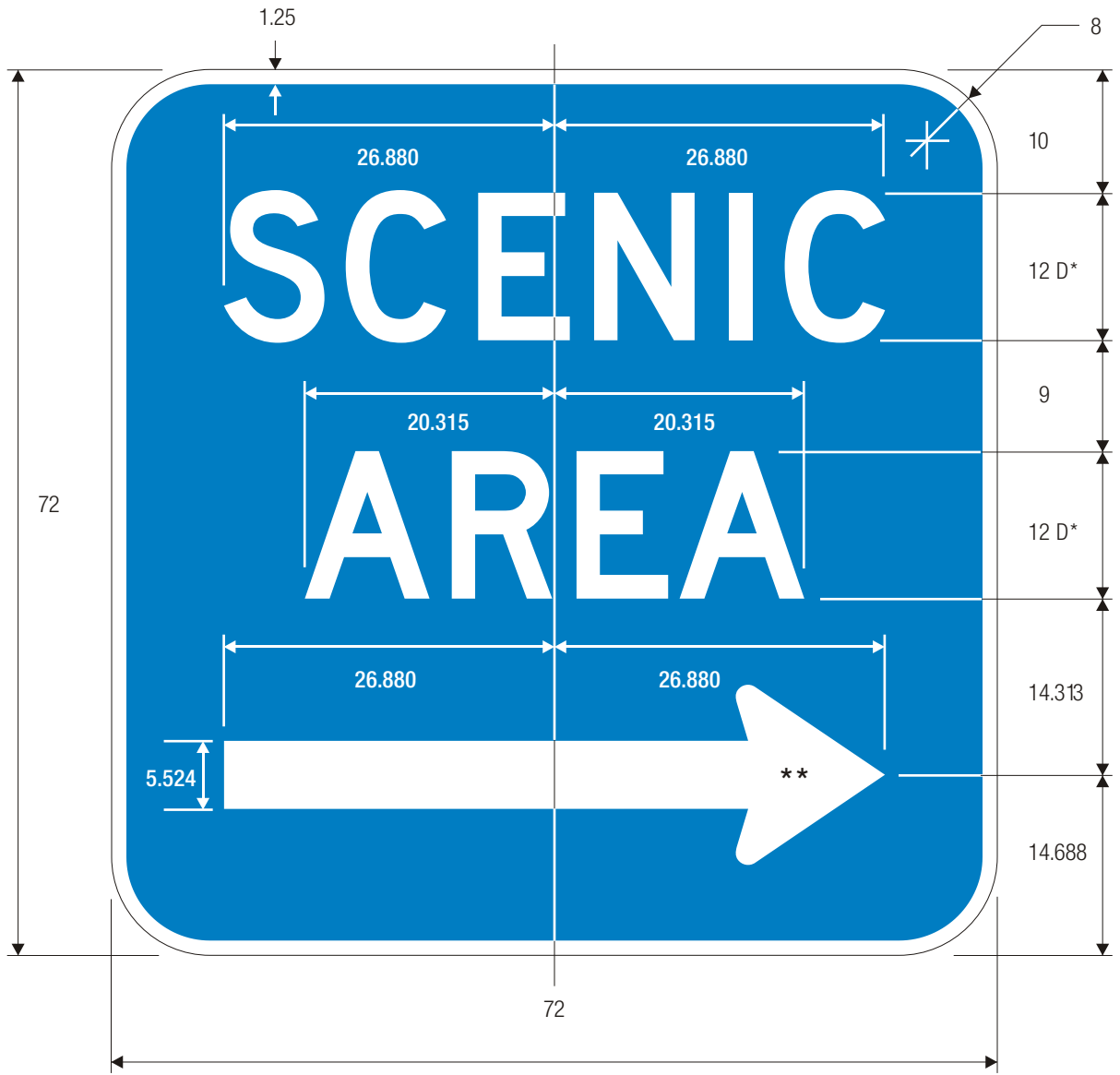

D6-1

SCENIC AREA ARROW

Option: The D6-1 thru D6-3 signs may have text "AREA", "VIEW" or "OVERLOOK".

*Series 2000 Standard Alphabets.
 **See page 6-2 for symbol design.

For SCENIC OVERLOOK use 84" width.

COLORS: LEGEND & ARROW – WHITE (RETROREFLECTIVE)
 BACKGROUND – BLUE (RETROREFLECTIVE)

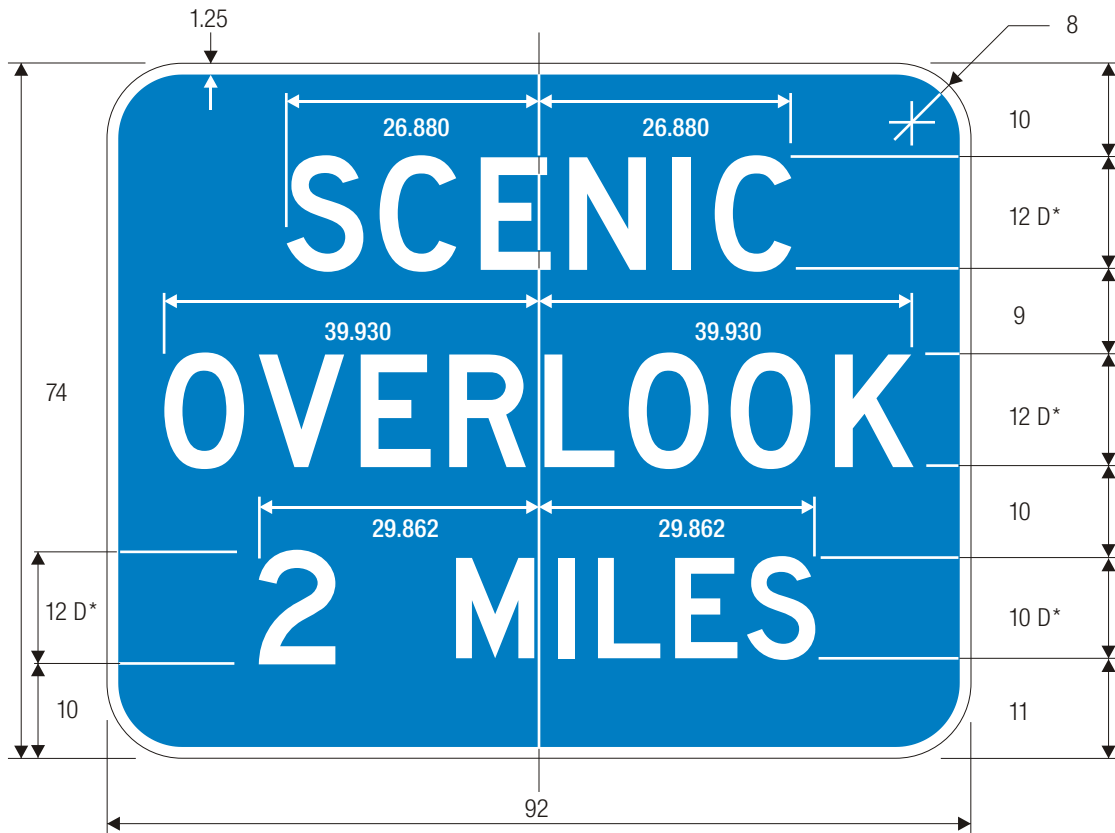

D6-2

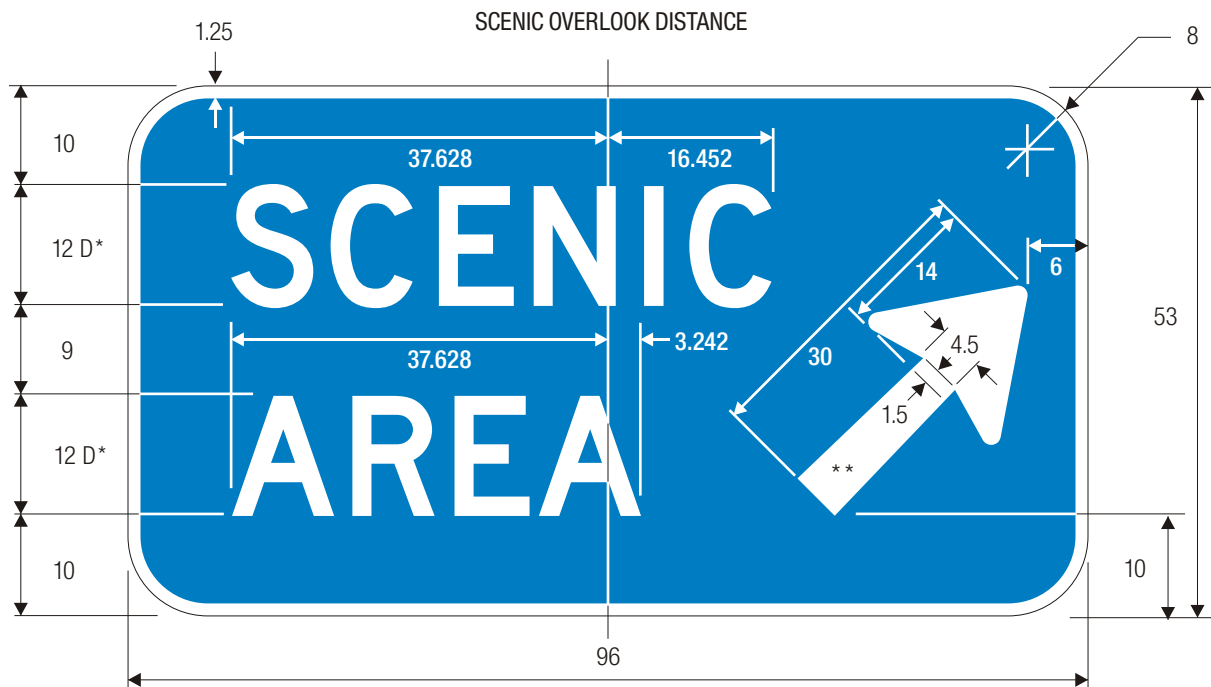

D6-3

SCENIC AREA EXIT DIRECTION

Option: The D6-1 thru D6-3 signs may have text "AREA", "VIEW" or "OVERLOOK".

*Series 2000 Standard Alphabets.

**See page 6-3 for symbol design.

COLORS: LEGEND & ARROW – WHITE (RETROREFLECTIVE)
 BACKGROUND – BLUE (RETROREFLECTIVE)

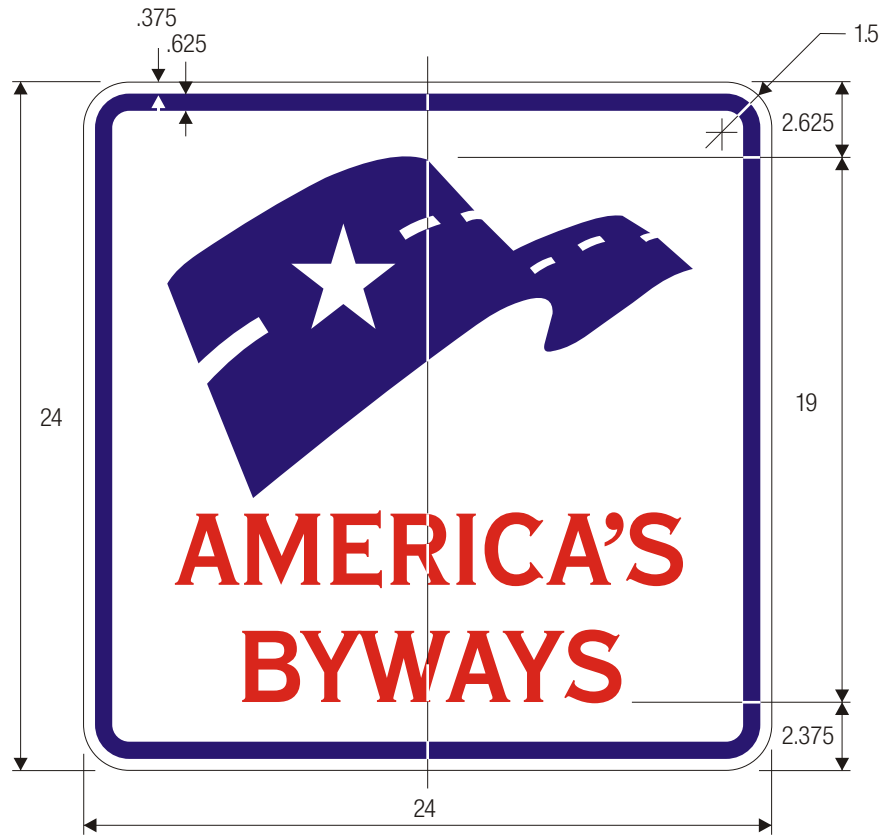

D6-4

NATIONAL SCENIC BYWAYS

*See page 6-61 for symbol design.

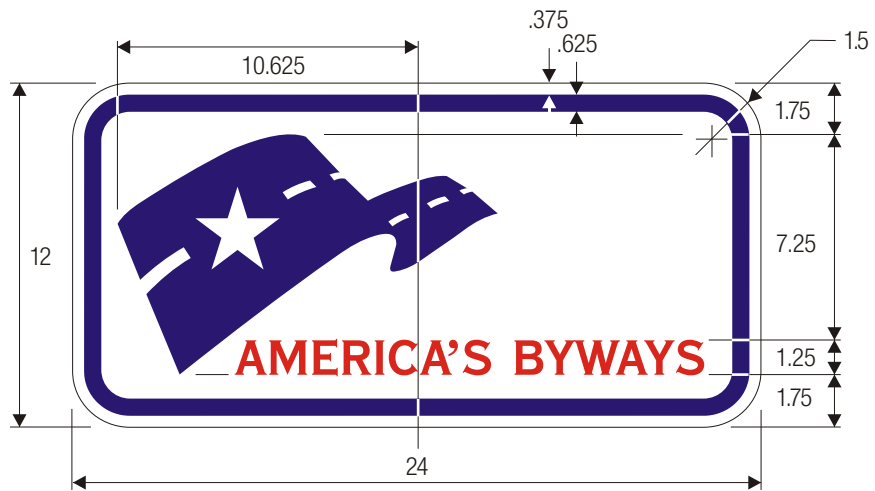

D6-4a

NATIONAL SCENIC BYWAYS

COLORS:	SYMBOL	BLUE & WHITE (RETROREFLECTIVE)
	LEGEND	RED (RETROREFLECTIVE)
	BACKGROUND	WHITE (RETROREFLECTIVE)



D7-1
NATIONAL PARK



D7-2
NATIONAL PARK ARROW

*See page 6-2 for arrow design.

COLORS: LEGEND —WHITE (RETROREFLECTIVE)
BACKGROUND —BROWN

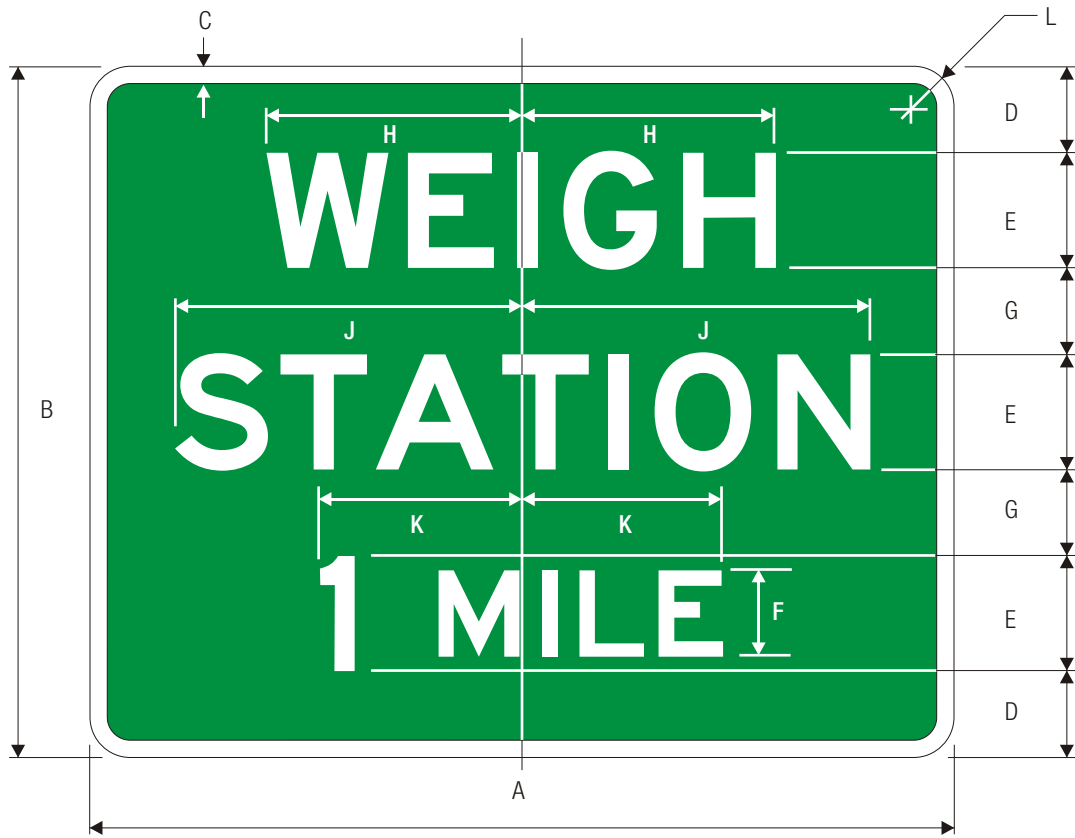

D8-1

ADVANCE WEIGH STATION DISTANCE

A	B	C	D	E	F	G	H	J	K	L
60	48	1.5	6	8 E	6 E	6	18	24.5	14	3
78	60	2	8	10 E	8 E	7	22.375	30.625	19	4
96	72	2	9	12 E	10 E	9	26.875	36.75	23.5	5

COLORS: LEGEND —WHITE (RETROREFLECTIVE)
 BACKGROUND —GREEN (RETROREFLECTIVE)

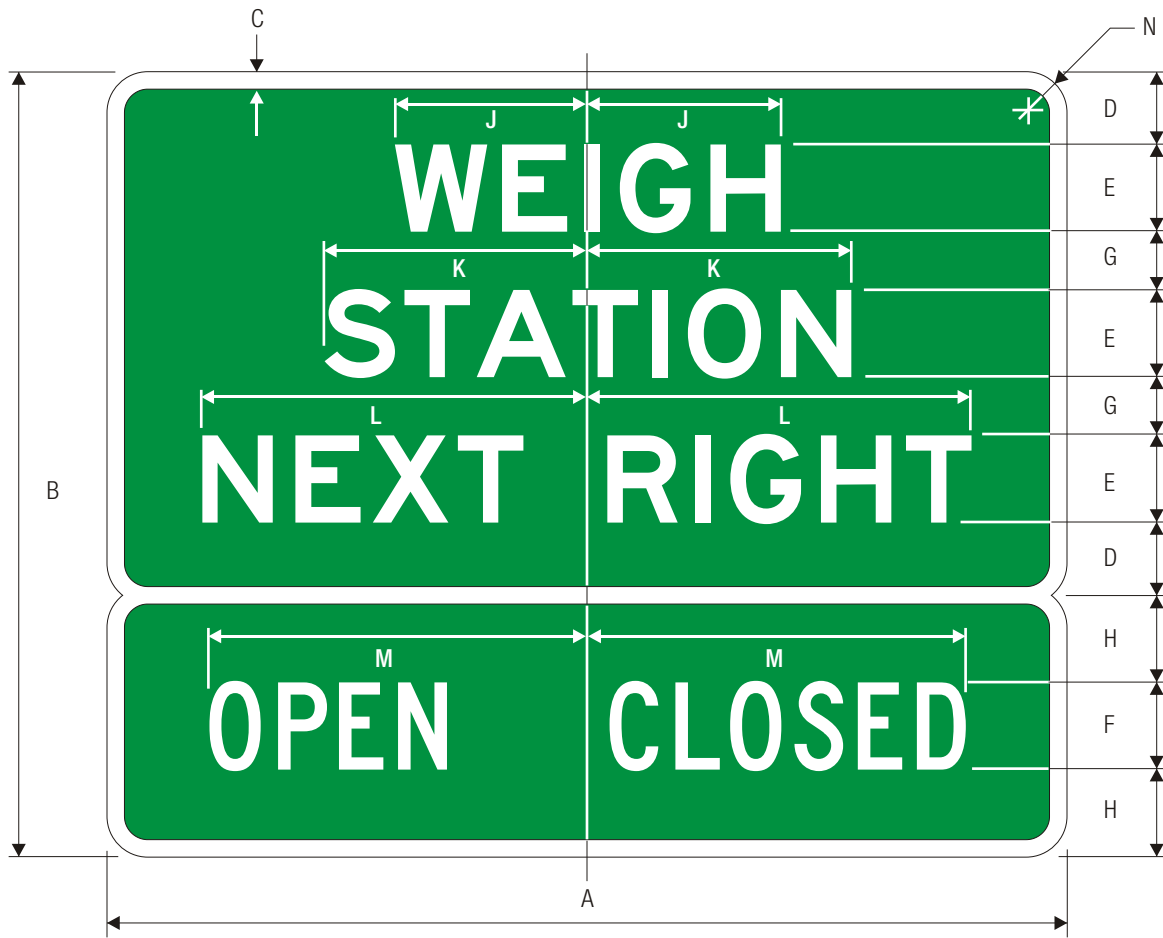

D8-2

WEIGH STATION NEXT RIGHT
(OPEN) (CLOSED)

A	B	C	D	E	F	G	H	J	K	L	M	N
66	54	1	5	6 E	6 C	4	6	12.5	18.5	27	26	4
84	72	1.5	6	8 E	8 C	6	8	18	24.5	36	35	5
108	90	2	8	10 E	10 C	7	10	22.375	30.625	45	44	6

COLORS: LEGEND -WHITE (RETROREFLECTIVE)
 BACKGROUND -GREEN (RETROREFLECTIVE)



D8-3

WEIGH STATION EXIT DIRECTION

*See page 6-3 for arrow design.

A	B	C	D	E	F	G	H	J	K	L	M
48	42	1	4	6 E	14	12.5	18.5	7	12	9.125	3
66	60	1.5	6	8 E	20	18	24.5	10	15.125	11.563	4
84	78	2	8	10 E	26	22.375	30.625	13	18.25	14	5

COLORS: LEGEND -WHITE (RETROREFLECTIVE)
 BACKGROUND -GREEN (RETROREFLECTIVE)

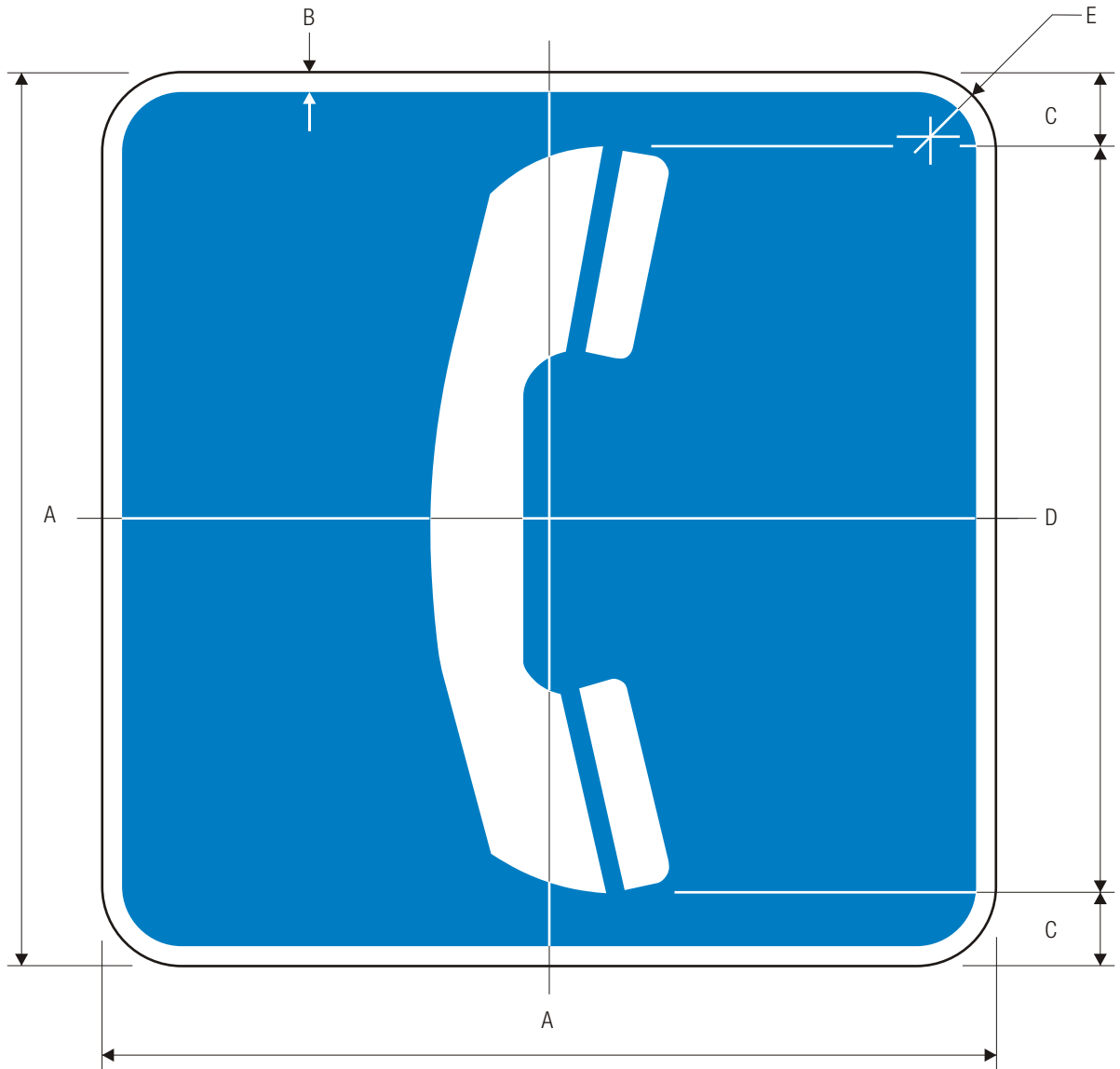

D9-1
TELEPHONE

*See page 6-44 for symbol design.

A	B	C	D	E
18	.5	1.5	15	1.5
24	.5	2	20	1.5
30	.75	2.5	25	1.875

COLORS: SYMBOL WHITE (RETROREFLECTIVE)
BACKGROUND BLUE (RETROREFLECTIVE)

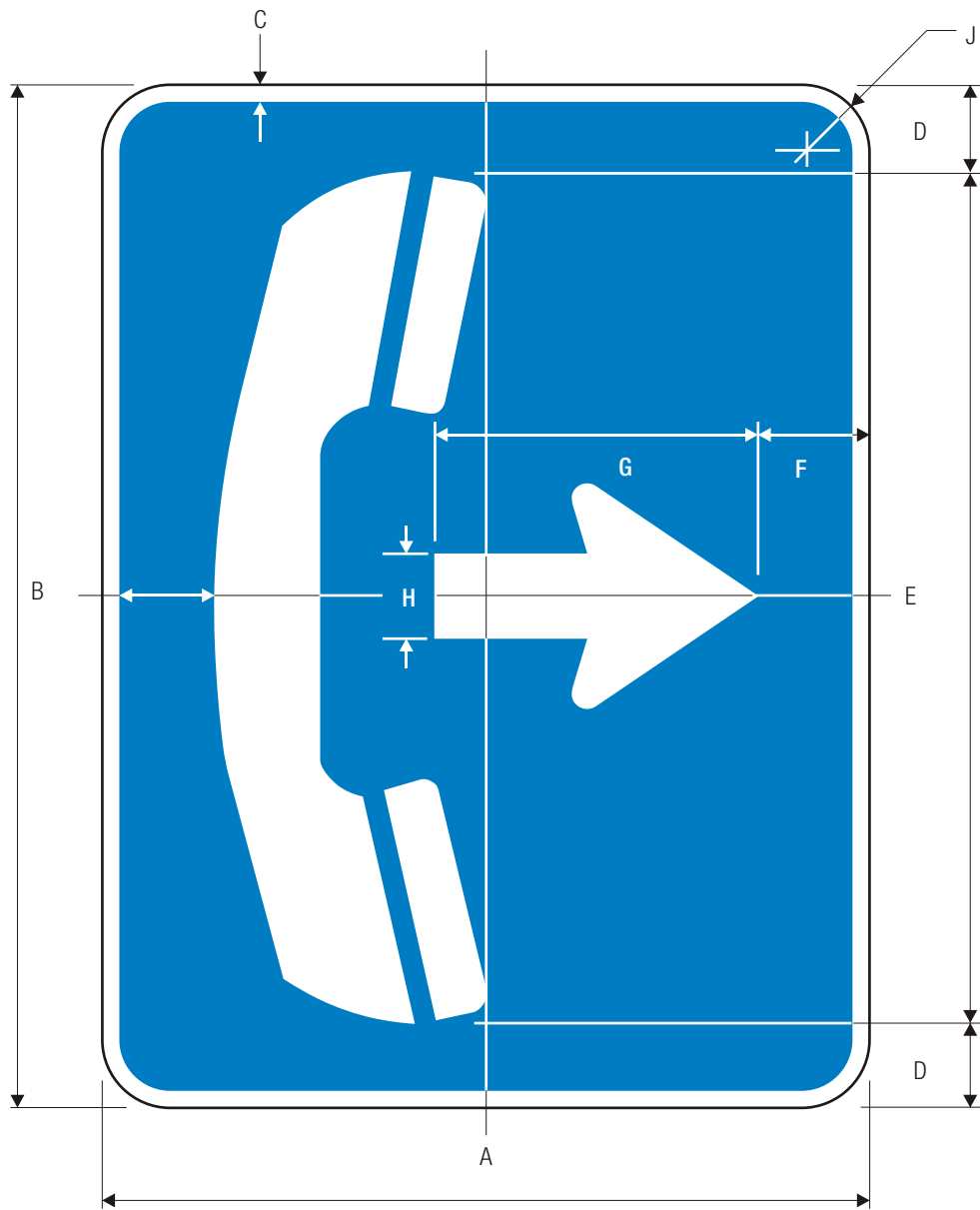

D9-1a

TELEPHONE

*See page 6-44 for symbol design.

**See page 6-2 for arrow design.

A	B	C	D	E	F	G	H	J
18	24	.5	2	20	1.75	8.5	2	1.5
24	30	.625	2.5	25	2.5	10.5	2.625	1.5
30	36	.75	3	30	3	13.25	3.25	1.875

COLORS: SYMBOL WHITE (RETROREFLECTIVE)
 BACKGROUND BLUE (RETROREFLECTIVE)

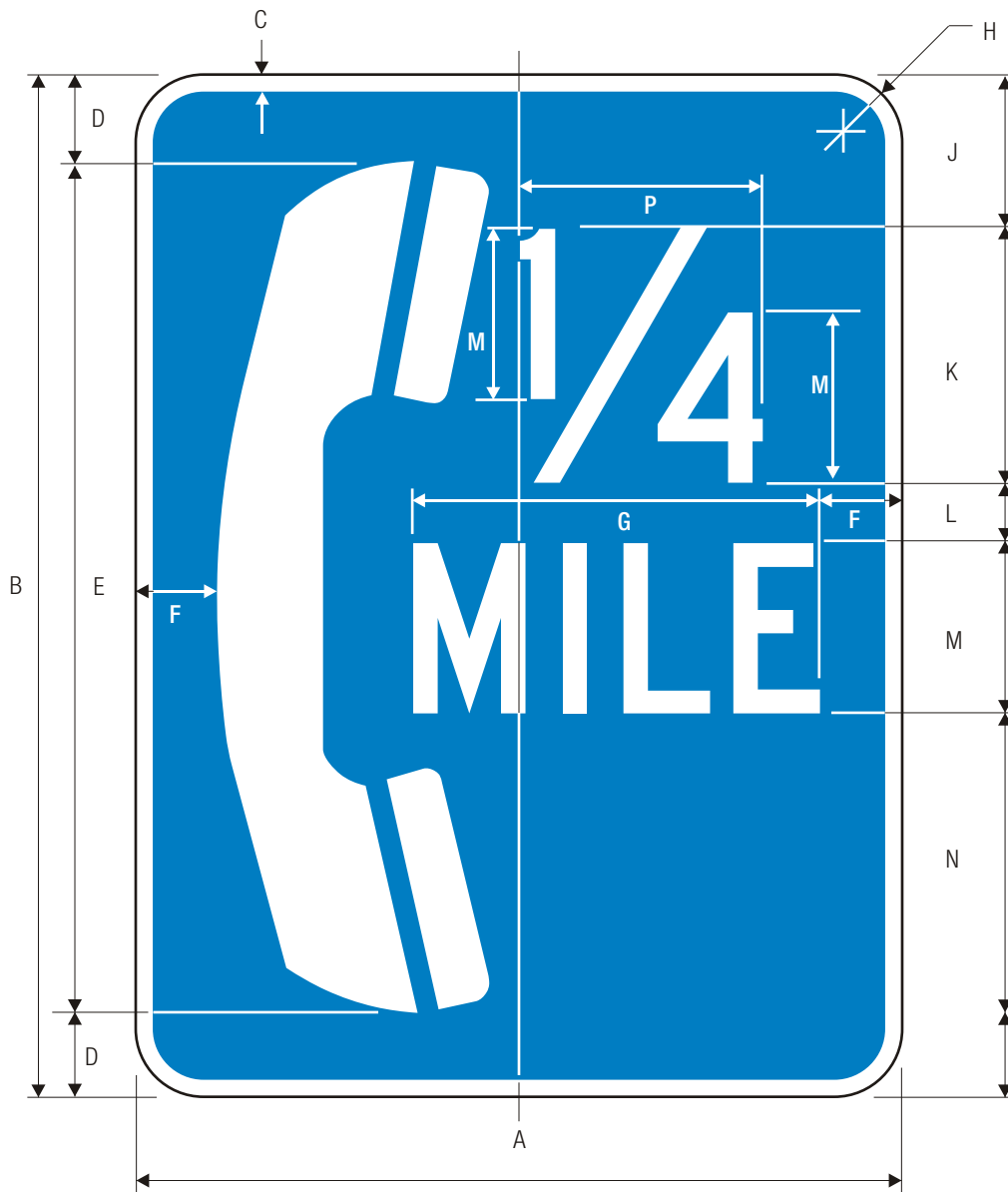

D9-1b
TELEPHONE

*See symbol on page 6-44

A	B	C	D	E	F	G	H	J	K	L	M
18	24	.5	2	20	1	9.5	1.5	3.75	6	1.5	4 C
24	30	.625	2.5	25	1.5	11.875	1.5	4.5	7.5	2	5 C
30	36	.75	3	30	2	14.25	1.875	5	9	2.5	6 C

N	P
8.75	8
11	10
13.5	12

COLORS: LEGEND —WHITE (RETROREFLECTIVE)
 BACKGROUND —BLUE (RETROREFLECTIVE)
 SYMBOL —WHITE (RETROREFLECTIVE)

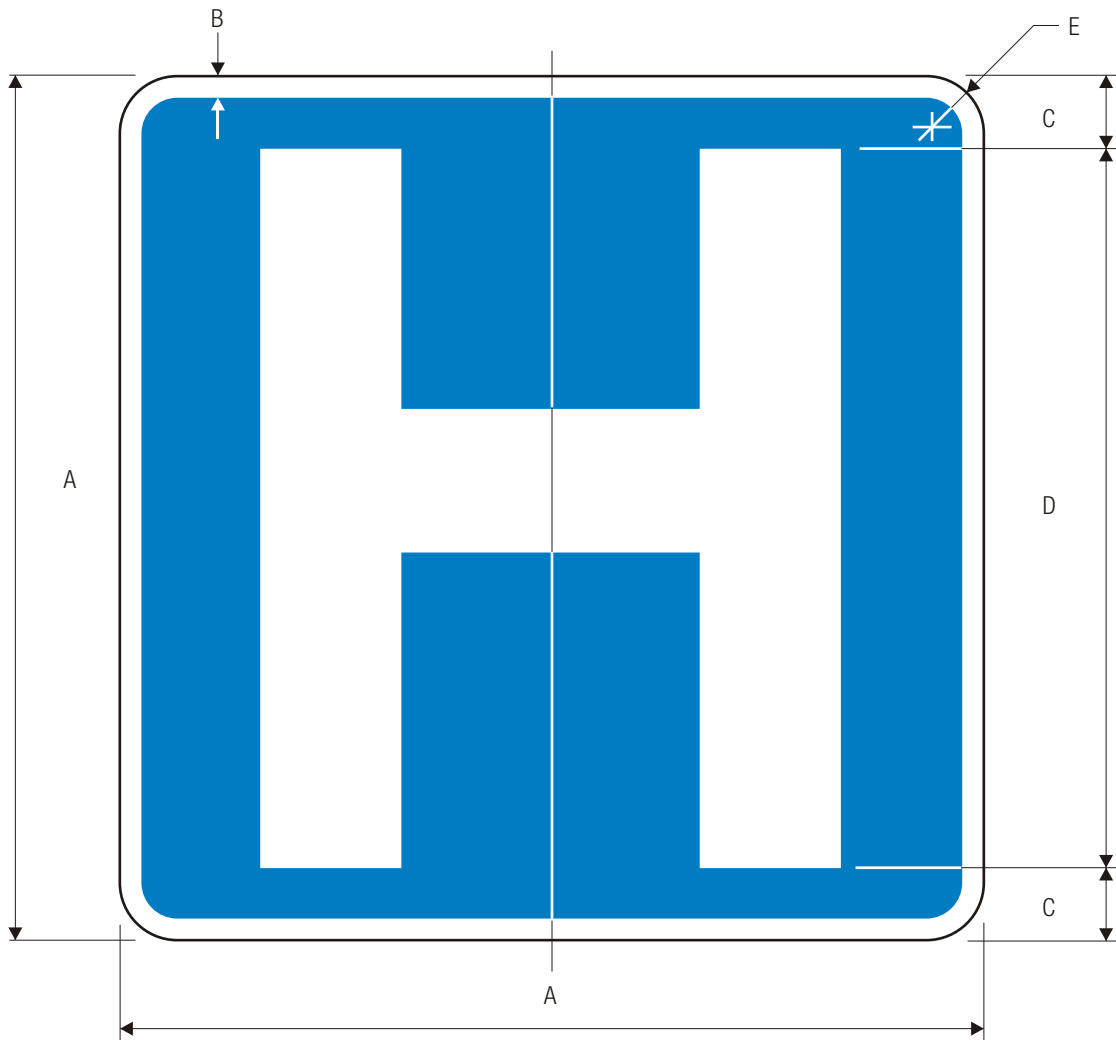

D9-2
HOSPITAL

A	B	C	D	E
18	.5	1.5	15 EM	1.5
24	.5	2	20 EM	1.5
30	.75	2.5	25	1.875

COLORS: LEGEND -WHITE (RETROREFLECTIVE)
BACKGROUND -BLUE (RETROREFLECTIVE)

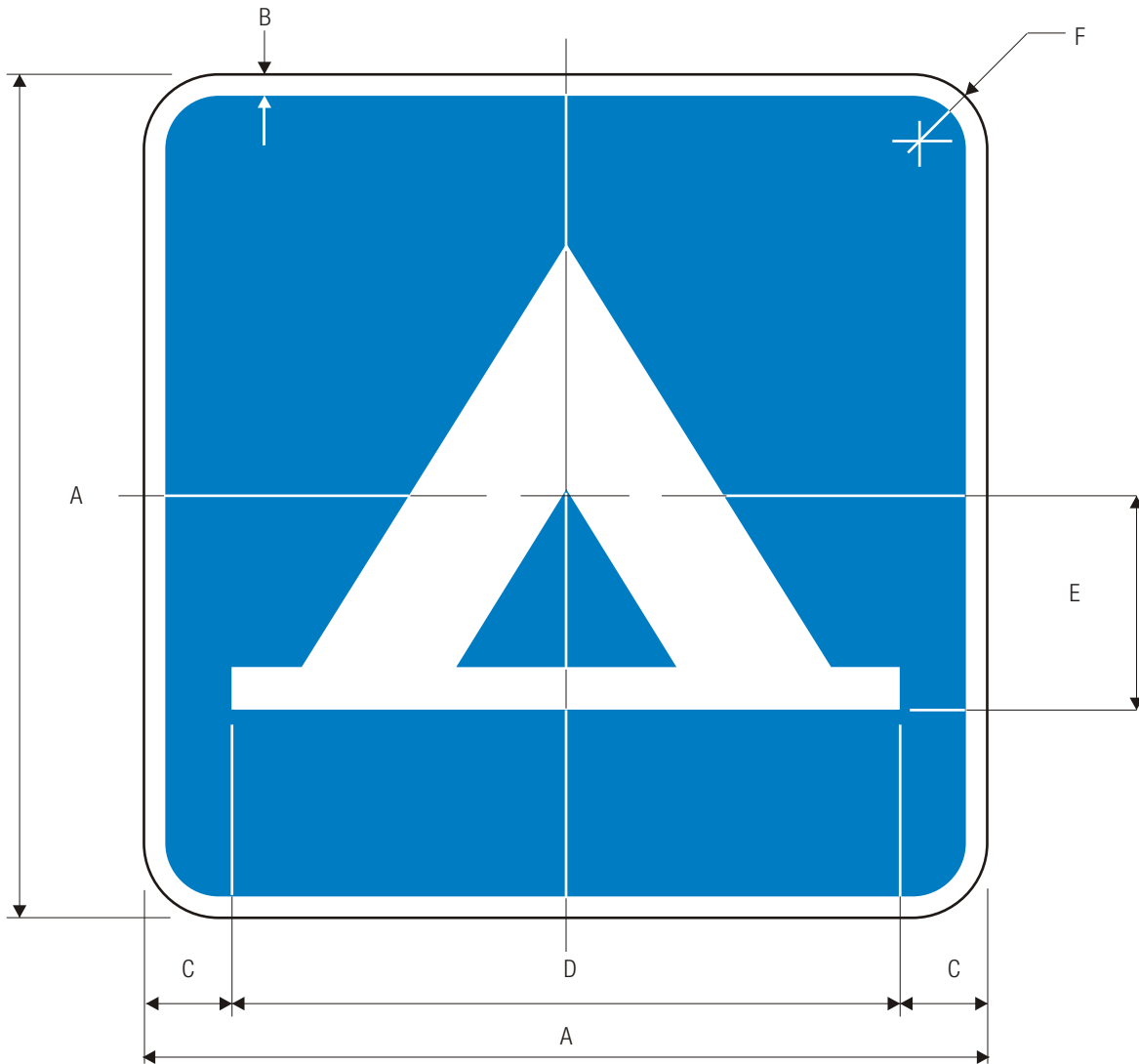

D9-3
CAMPING

*See page 6-45 for symbol design.

A	B	C	D	E	F
18	.5	1.5	15	6	1.5
24	.5	2	20	8	1.5
30	.75	2.5	25	10	1.875

COLORS: SYMBOL WHITE (RETROREFLECTIVE)
BACKGROUND BLUE (RETROREFLECTIVE)

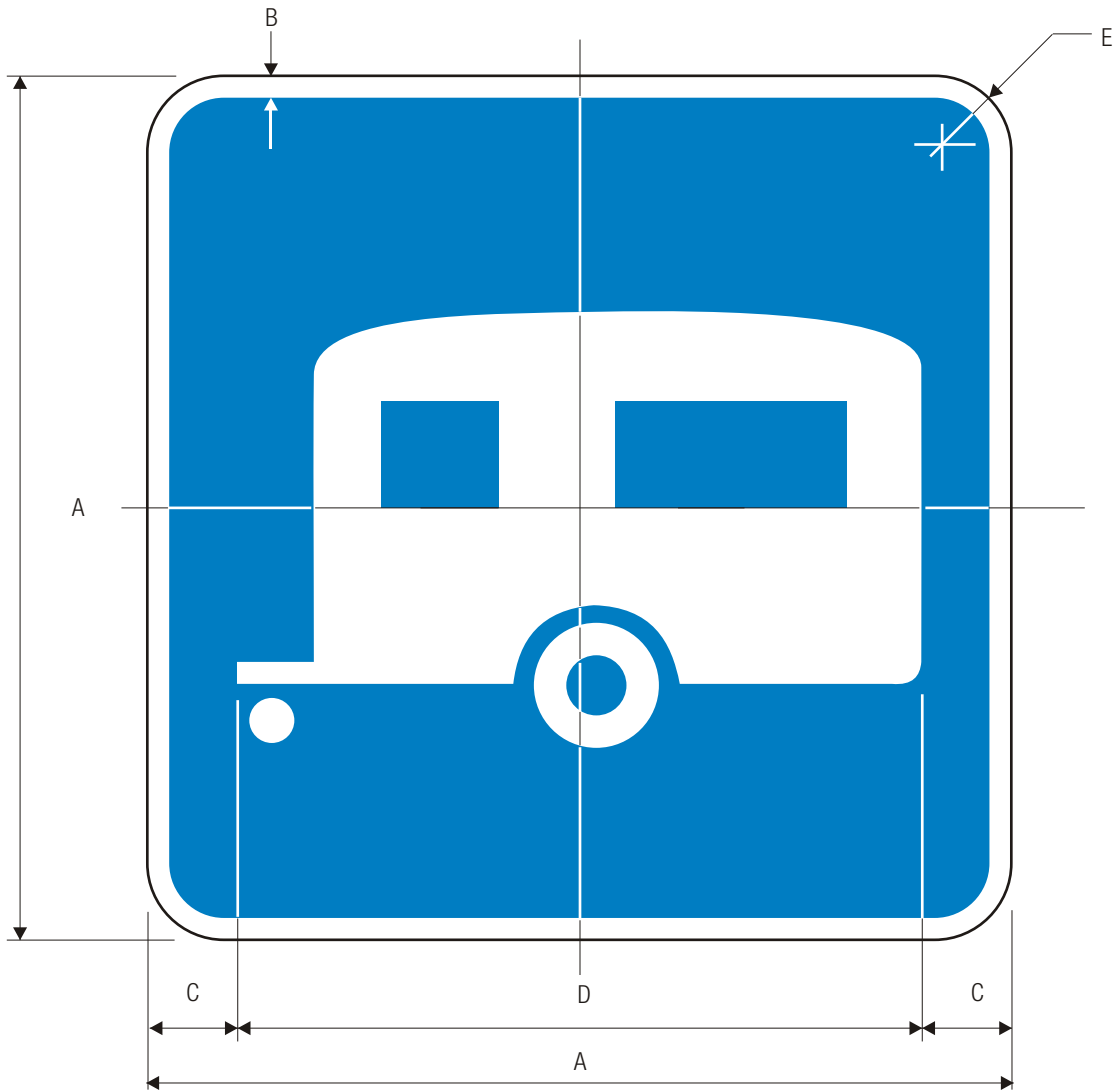

D9-3a

TRAILER CAMPING

*See page 6-46 for symbol design.

A	B	C	D	E
18	.5	1.5	15	1.5
24	.5	2	20	1.5
30	.75	2.5	25	1.875

COLORS: SYMBOL WHITE (RETROREFLECTIVE)
 BACKGROUND BLUE (RETROREFLECTIVE)



D9-4

LITTER CONTAINER

*See page 6-15 for symbol design.

A	B	C	D	E	F
24	30	.5	5	20	1.5
36	48	.75	8	32	2.25

COLORS: SYMBOL WHITE (RETROREFLECTIVE)
 BACKGROUND BLUE (RETROREFLECTIVE)

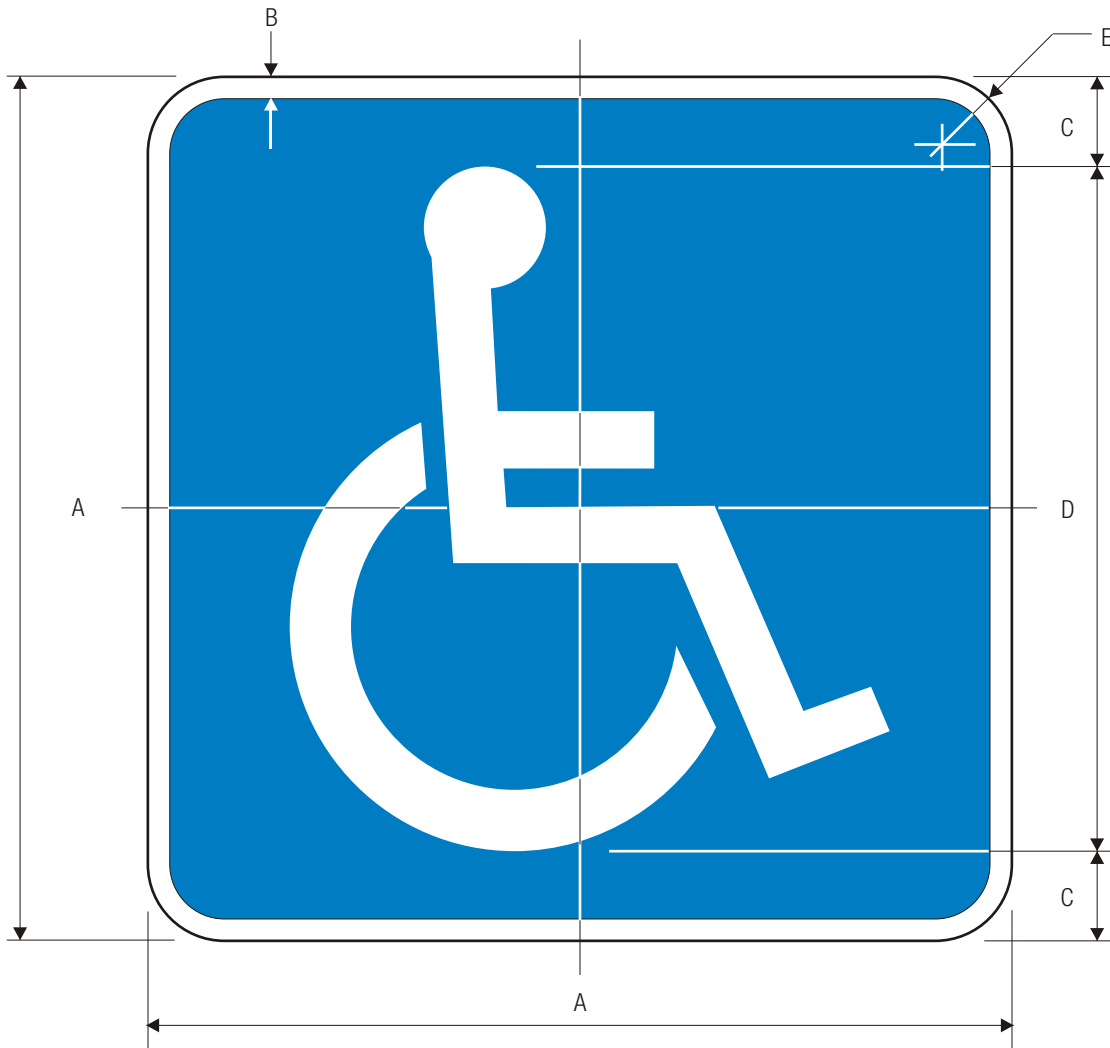

D9-6

HANDICAPPED ACCESSIBLE

*See page 6-31 for symbol design.

Smaller size panels may be used as applicable within terminal areas

A	B	C	D	E
18	.5	1.5	15	1.5
24	.5	2	20	1.5
30	.75	2.5	25	1.875

COLORS: SYMBOL WHITE (RETROREFLECTIVE)
 BACKGROUND BLUE (RETROREFLECTIVE)

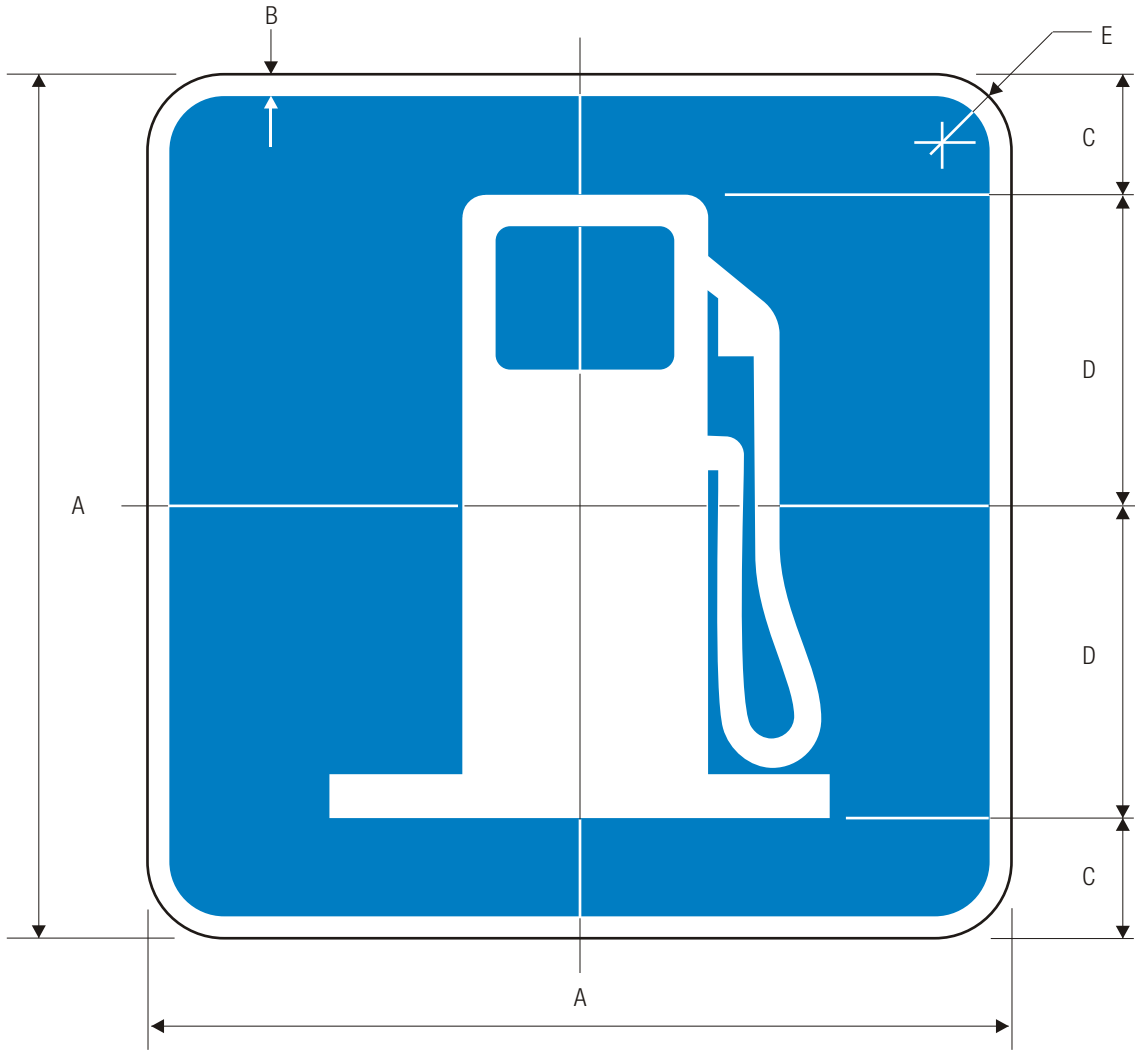

D9-7
GAS

*See page 6-12 for symbol design.

A	B	C	D	E
18	.5	3	6	1.5
24	.5	3	9	1.5
30	.75	3.75	11.25	1.875

COLORS: SYMBOL WHITE (RETROREFLECTIVE)
BACKGROUND BLUE (RETROREFLECTIVE)

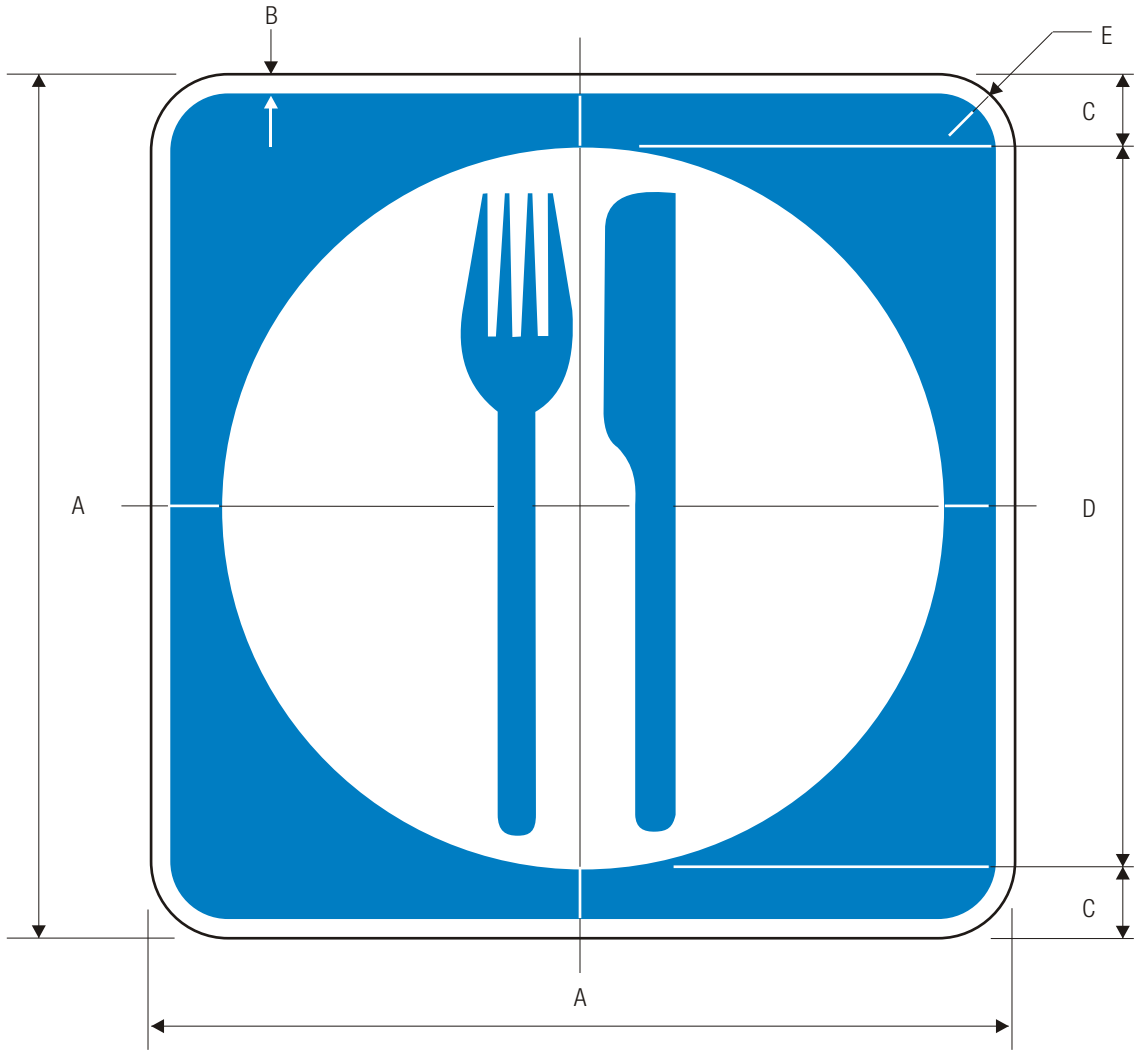

D9-8
FOOD

*See page 6-47 for symbol design.

A	B	C	D	E
18	.5	1.5	15	1.5
24	.5	2	20	1.5
30	.75	2.5	25	1.875

COLORS: SYMBOL WHITE (RETROREFLECTIVE)
BACKGROUND BLUE (RETROREFLECTIVE)

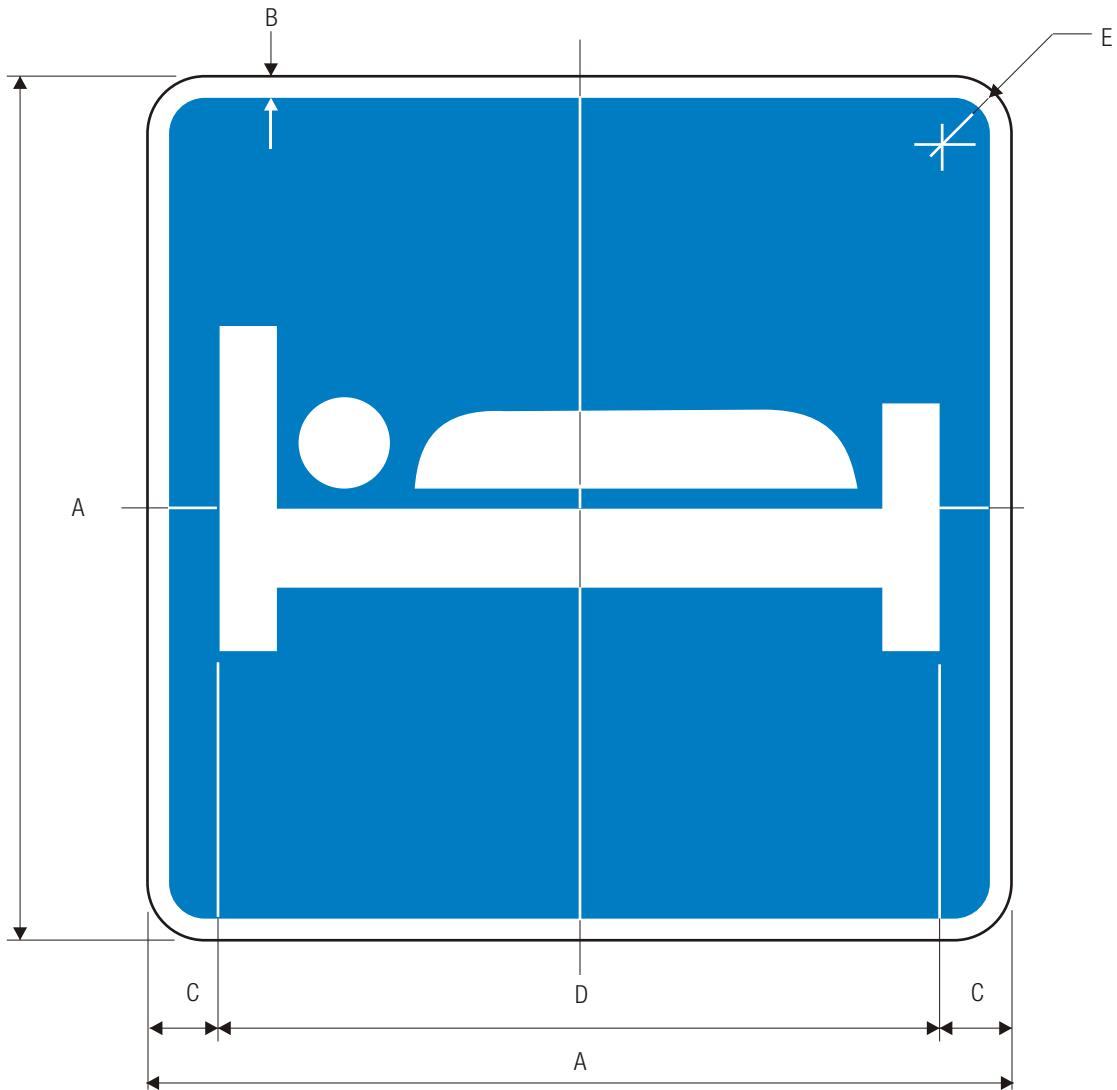

D9-9
LODGING

*See page 6-48 for symbol design.

A	B	C	D	E
18	.5	1.5	15	1.5
24	.5	2	20	1.5
30	.75	2.5	25	1.875

COLORS: SYMBOL WHITE (RETROREFLECTIVE)
BACKGROUND BLUE (RETROREFLECTIVE)

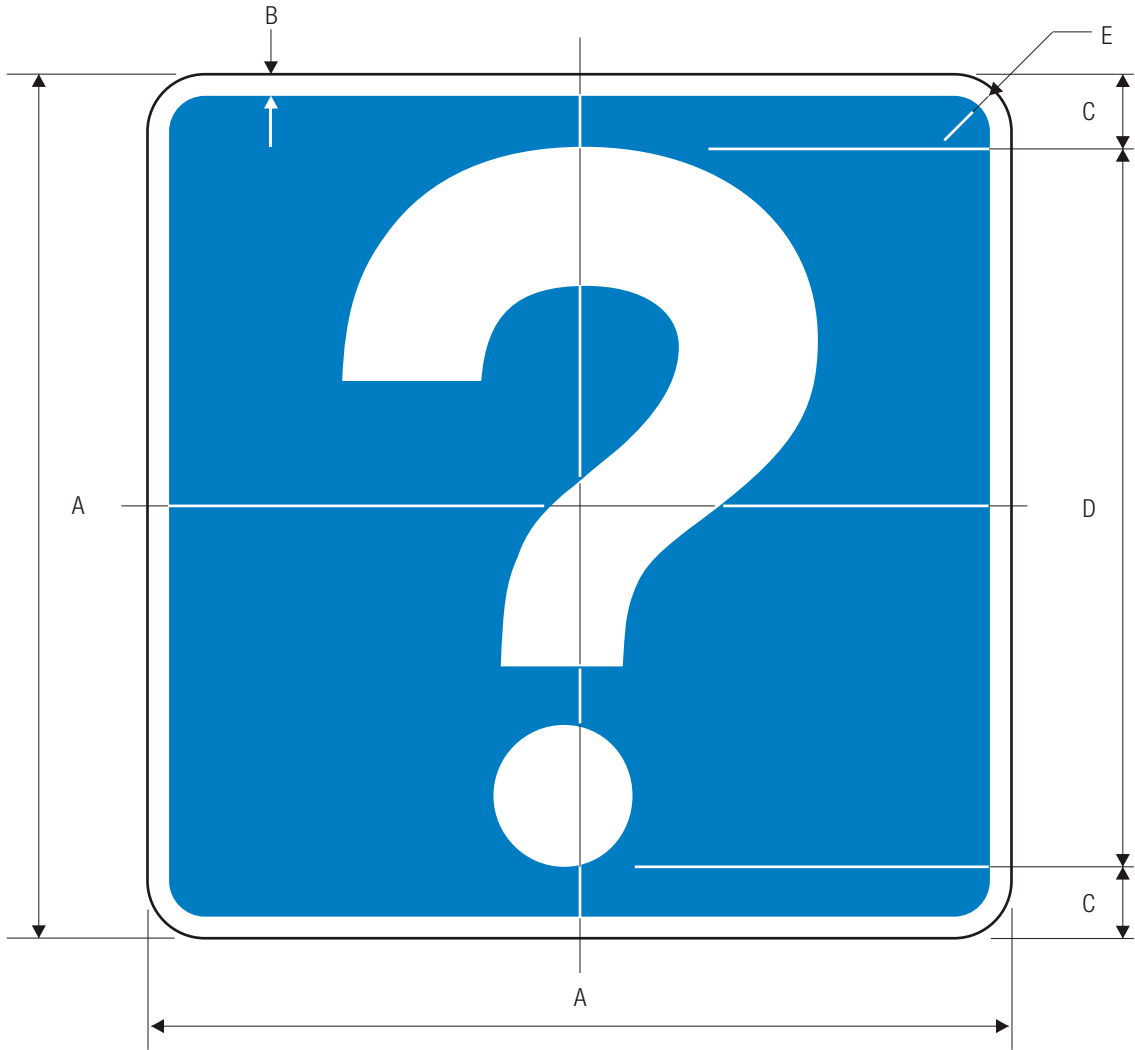

D9-10

TOURIST INFORMATION

*See page 6-49 for symbol design.

A	B	C	D	E
18	.5	1.5	15	1.5
24	.5	2	20	1.5
30	.75	2.5	26	1.875

COLORS: SYMBOL WHITE (RETROREFLECTIVE)
 BACKGROUND BLUE (RETROREFLECTIVE)

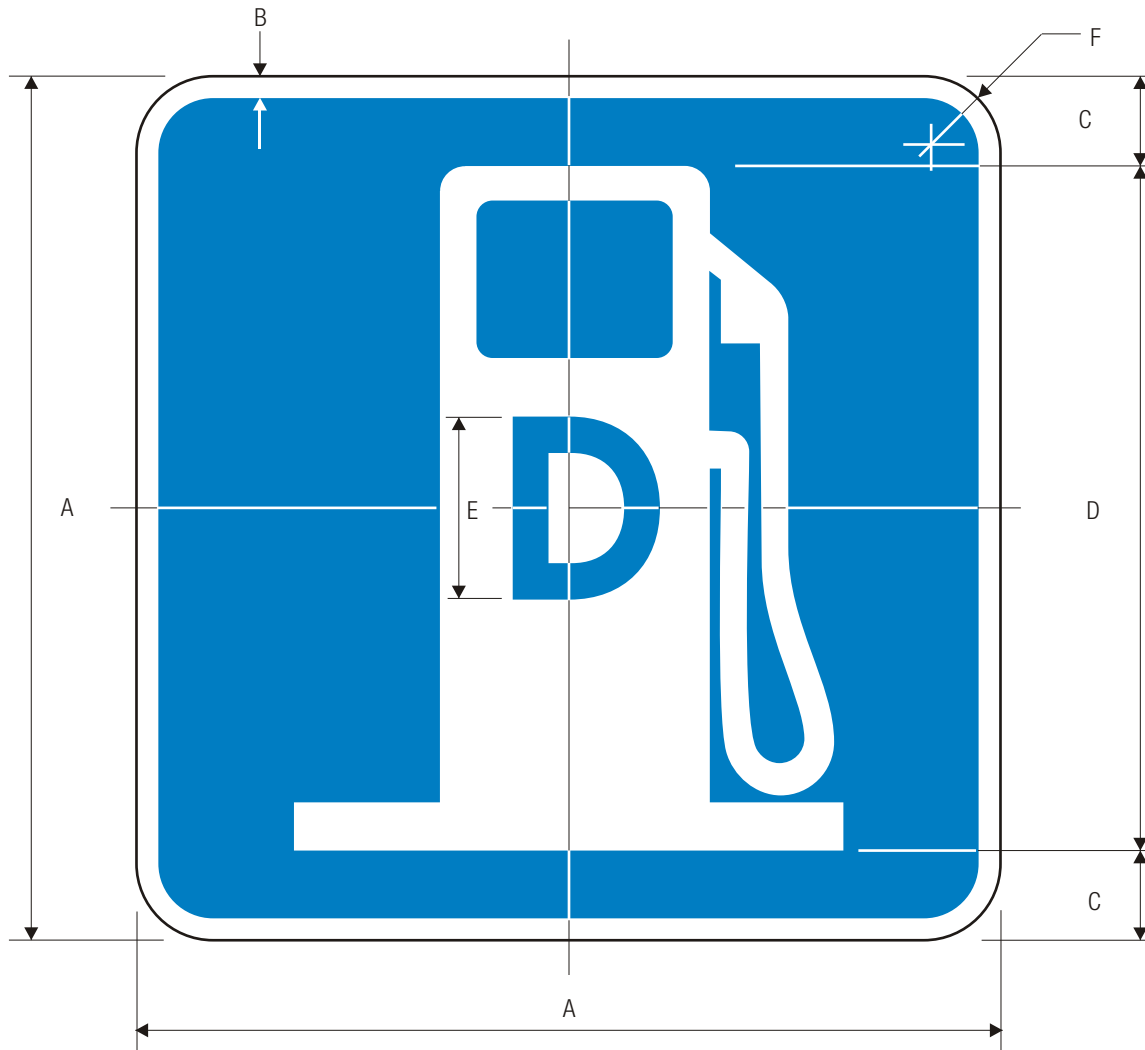

D9-11

DIESEL FUEL

*See page 6-12 for symbol design.

A	B	C	D	E	F
18	.5	1.5	15	4 EM	1.5
24	.5	2	20	6 EM	1.5
30	.75	2.5	25	8 EM	1.875

COLORS: SYMBOL WHITE (RETROREFLECTIVE)
 BACKGROUND BLUE (RETROREFLECTIVE)

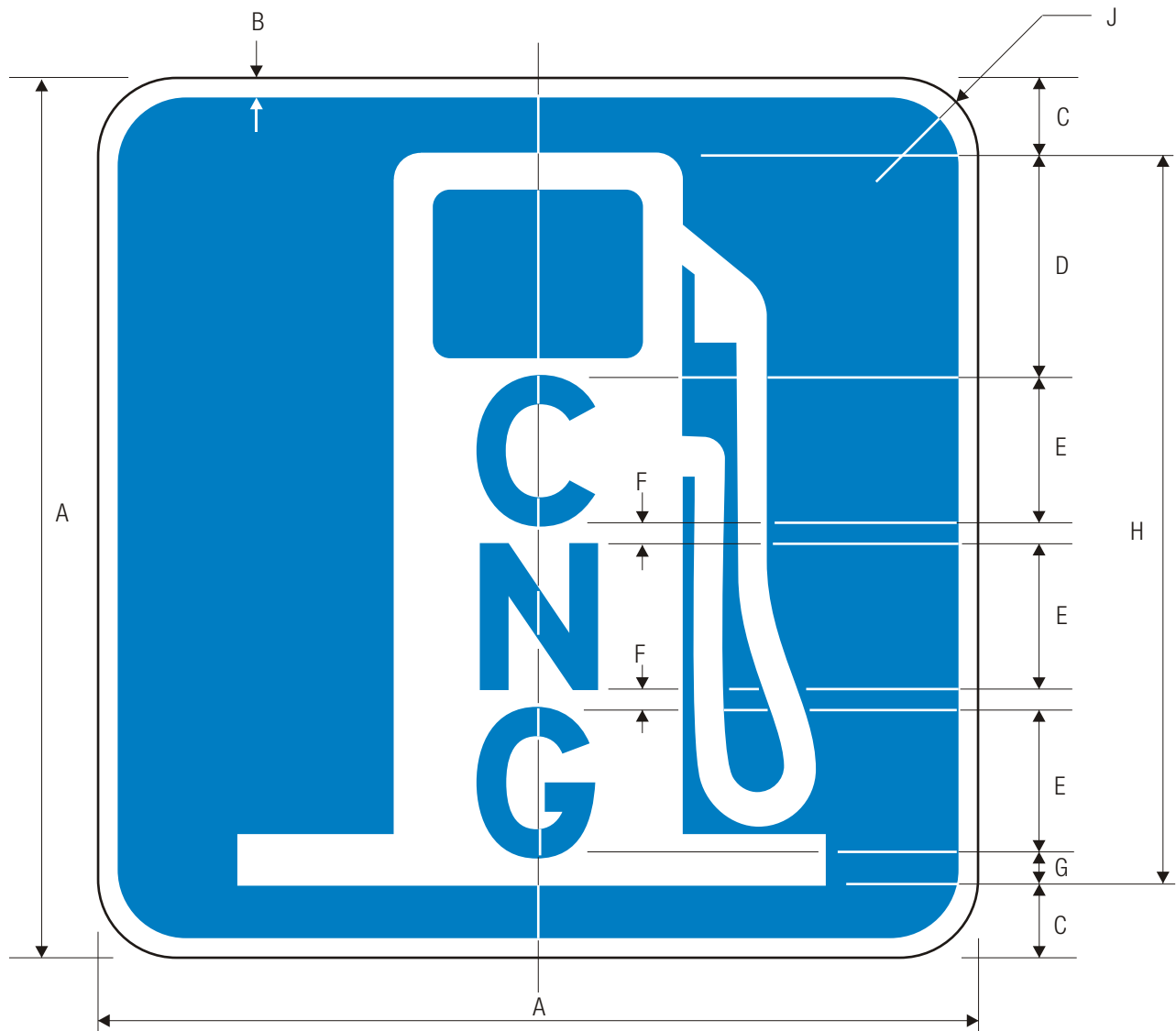

D9-11a
ALTERNATIVE FUEL

*See page 6-12 for design.

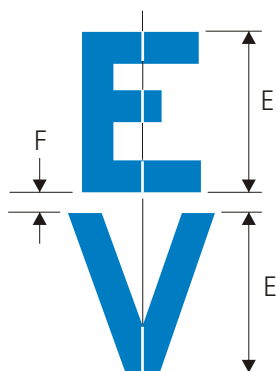

A	B	C	D	E	F	G	H	J
18	.5	1.5	4.5	3 EM	.5	.5	15	1.5
24	.5	2	6	4 EM	.625	.75	19.75	1.5
30	.75	2.5	7.625	5 EM	.688	1	25	1.875

COLORS: LEGEND BLUE (RETROREFLECTIVE)
 SYMBOL WHITE (RETROREFLECTIVE)
 BACKGROUND BLUE (RETROREFLECTIVE)

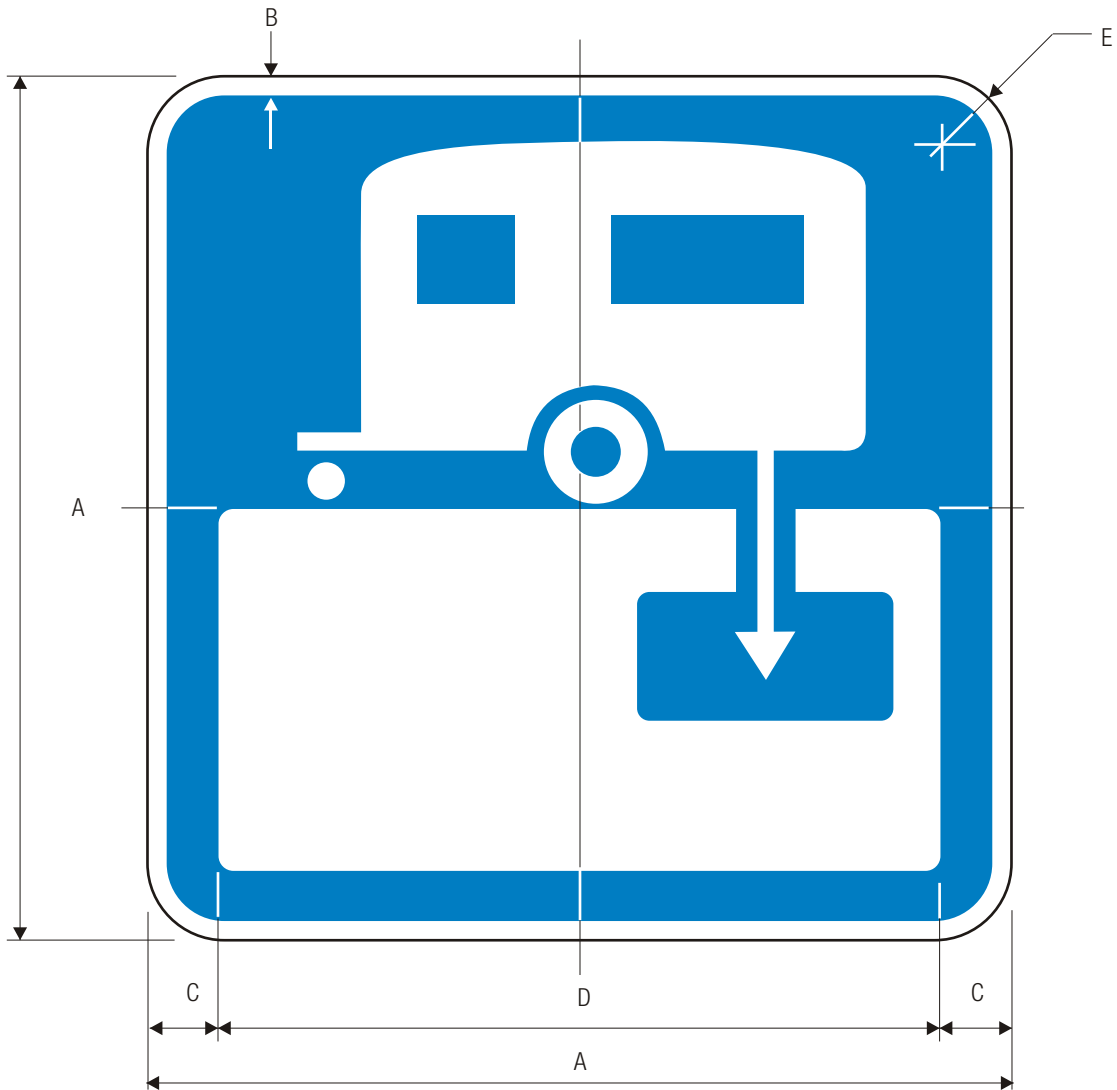

D9-12

RV SANITARY STATION

*See page 6-50 for symbol design.

A	B	C	D	E
18	.5	1.5	15	1.5
24	.5	2	20	1.5
30	.75	2.5	25	1.875

COLORS: SYMBOL WHITE (RETROREFLECTIVE)
 BACKGROUND BLUE (RETROREFLECTIVE)

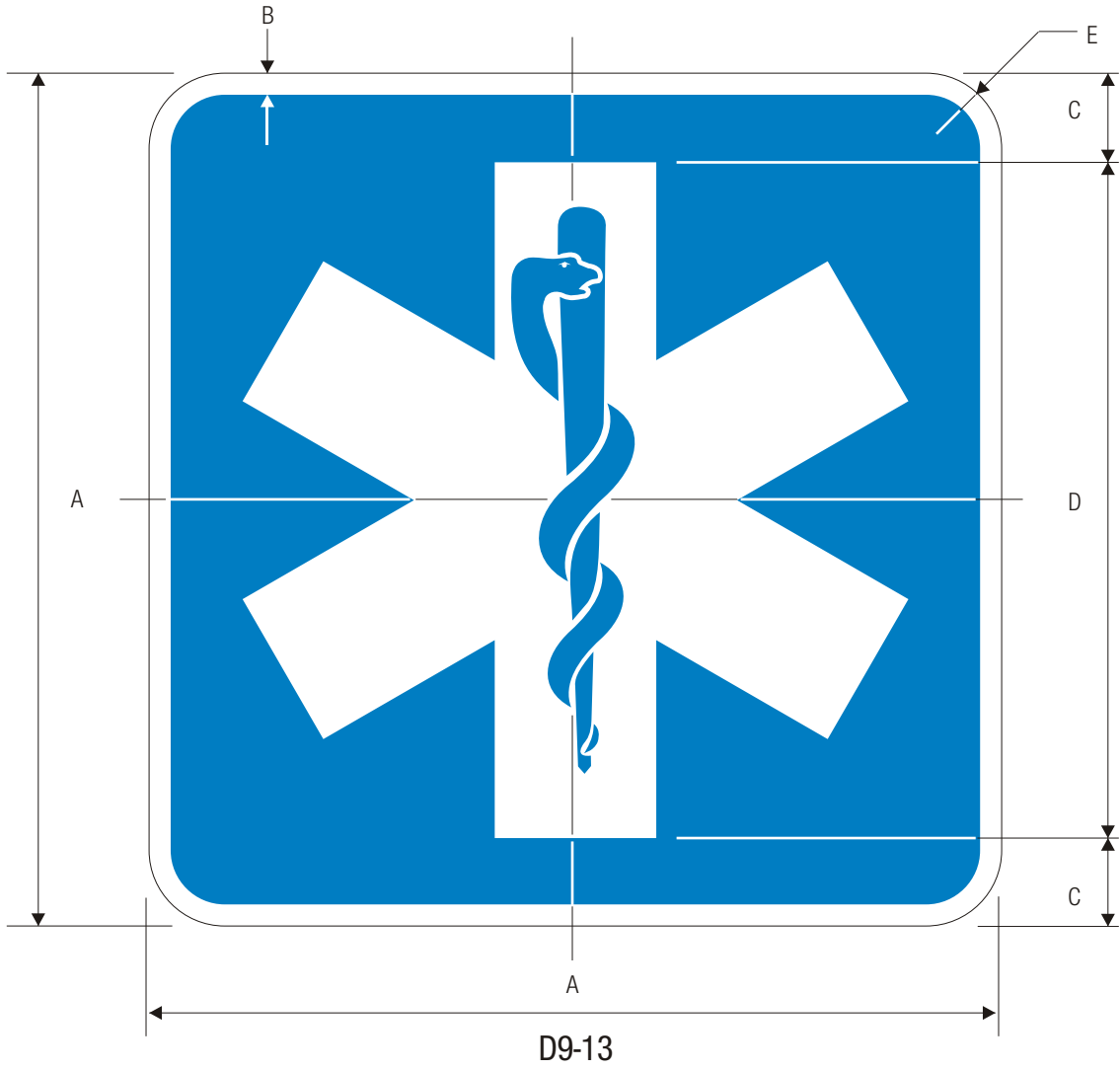

EMERGENCY MEDICAL SERVICES

*See page 6-51 for symbol design.

A	B	C	D	E
18	.5	1.5	15	1.5
24	.5	2	20	1.5
30	.75	2.5	25	1.875

COLORS: SYMBOL WHITE (RETROREFLECTIVE)
 BACKGROUND BLUE (RETROREFLECTIVE)

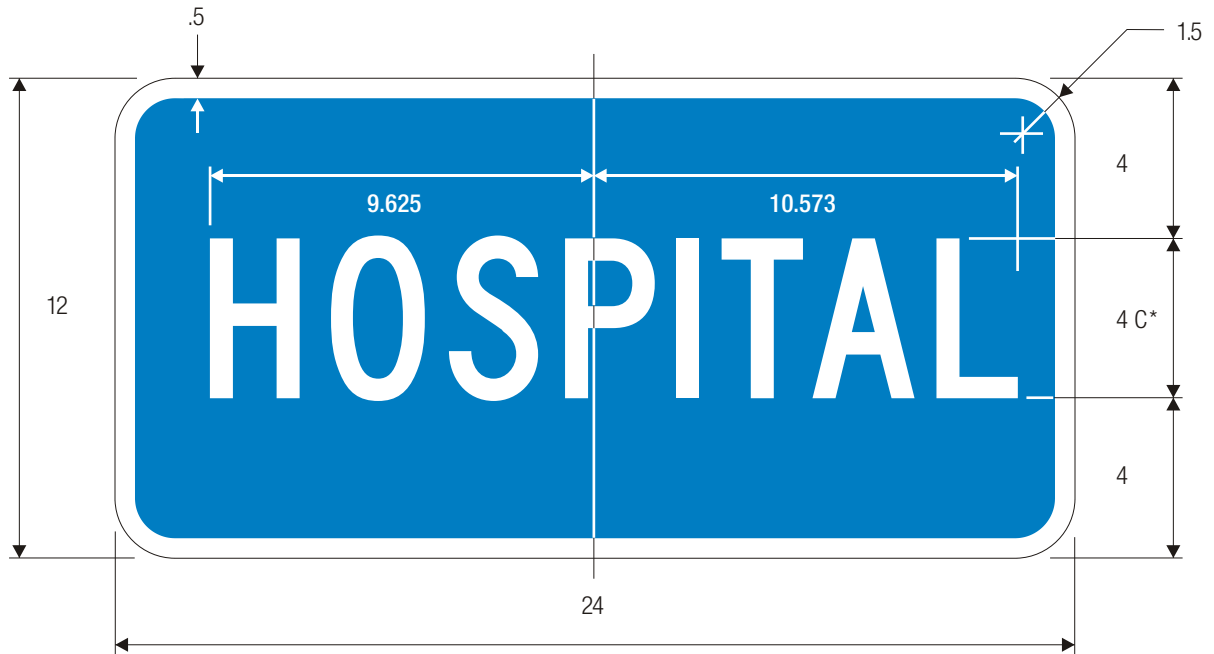

D9-13a
HOSPITAL

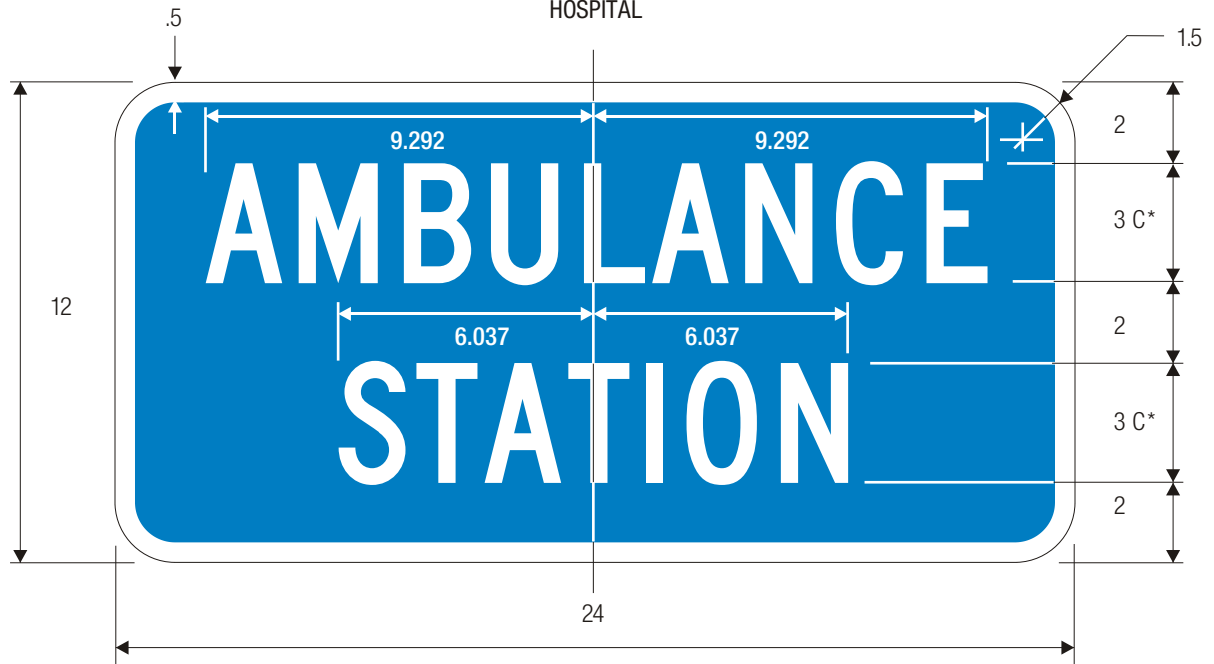

D9-13b
AMBULANCE STATION

*Series 2000 Standard Alphabets.

COLORS: SYMBOL WHITE (RETROREFLECTIVE)
BACKGROUND BLUE (RETROREFLECTIVE)

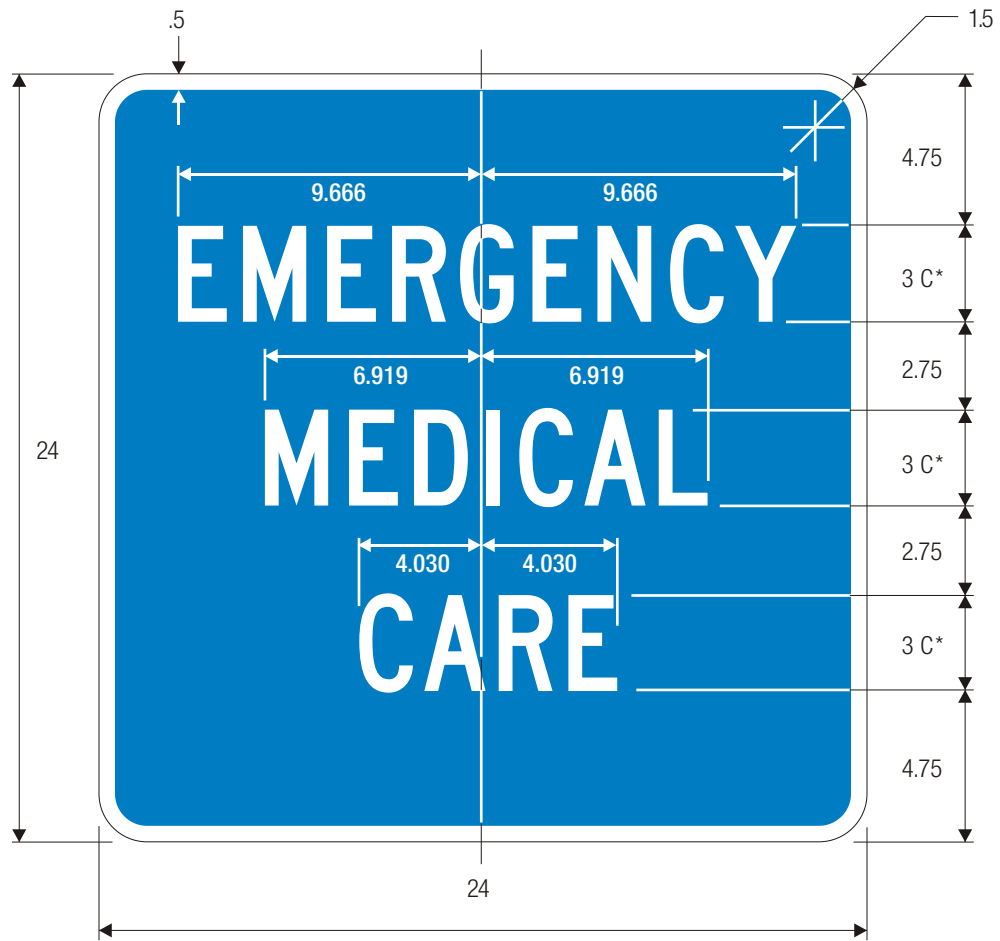

D9-13c

EMERGENCY MEDICAL CARE

*Series 2000 Standard Alphabets.

COLORS: SYMBOL WHITE (RETROREFLECTIVE)
 BACKGROUND BLUE (RETROREFLECTIVE)



D9-14

POLICE

A	B	C	D	E	F	G
24	12	.5	3	6 C	10.375	1.5
30	15	.5	3.5	8 C	13	1.5

COLORS: SYMBOL WHITE (RETROREFLECTIVE)
 BACKGROUND BLUE (RETROREFLECTIVE)

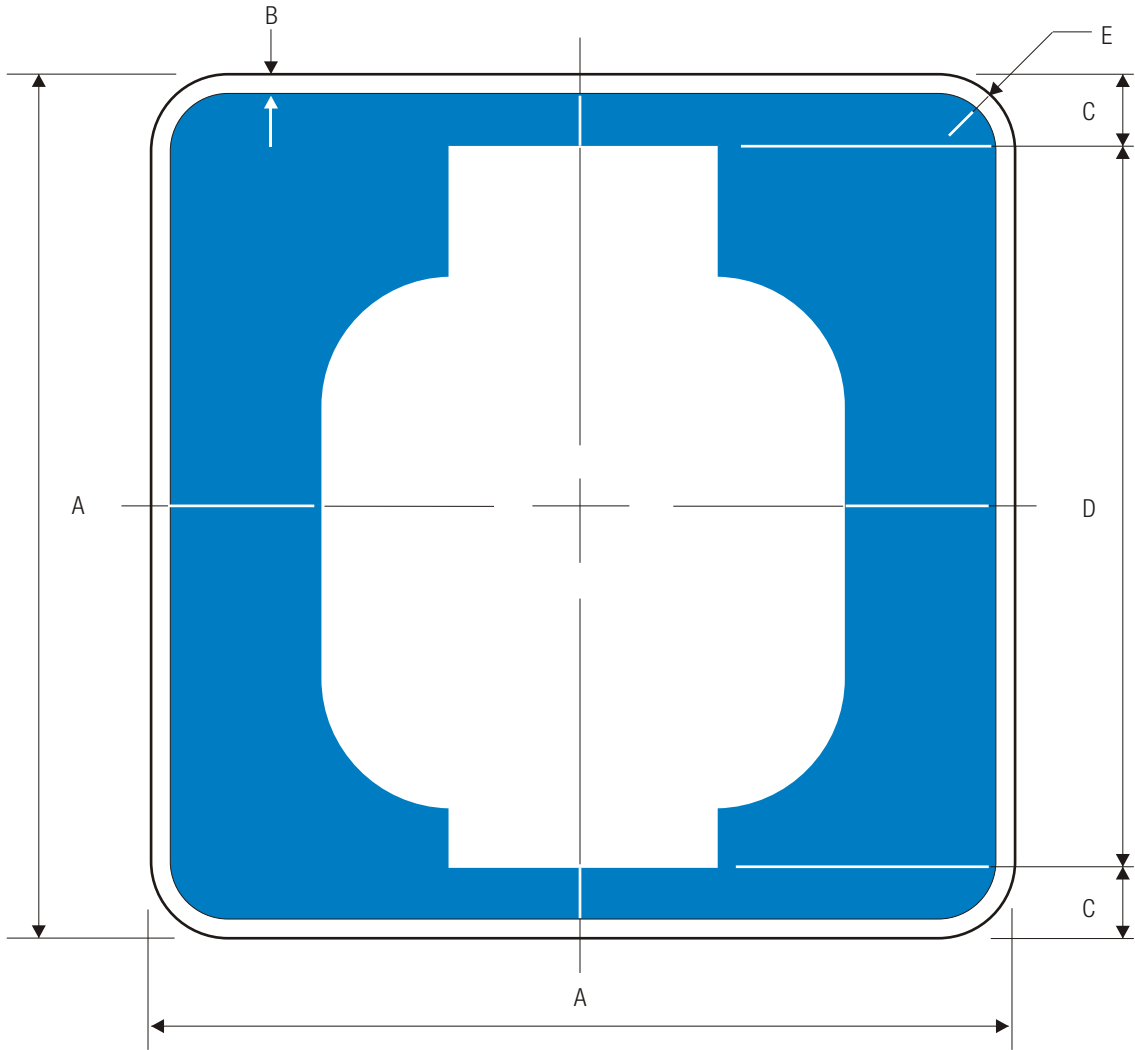

D9-15

PROPANE GAS

*See page 6-52 for symbol design.

Smaller size panels may be used as applicable within terminal areas.

A	B	C	D	E
18	.5	1.5	15	1.5
24	.5	2	20	1.5
30	.75	2.5	25	1.875

COLORS: SYMBOL WHITE (RETROREFLECTIVE)
 BACKGROUND BLUE (RETROREFLECTIVE)

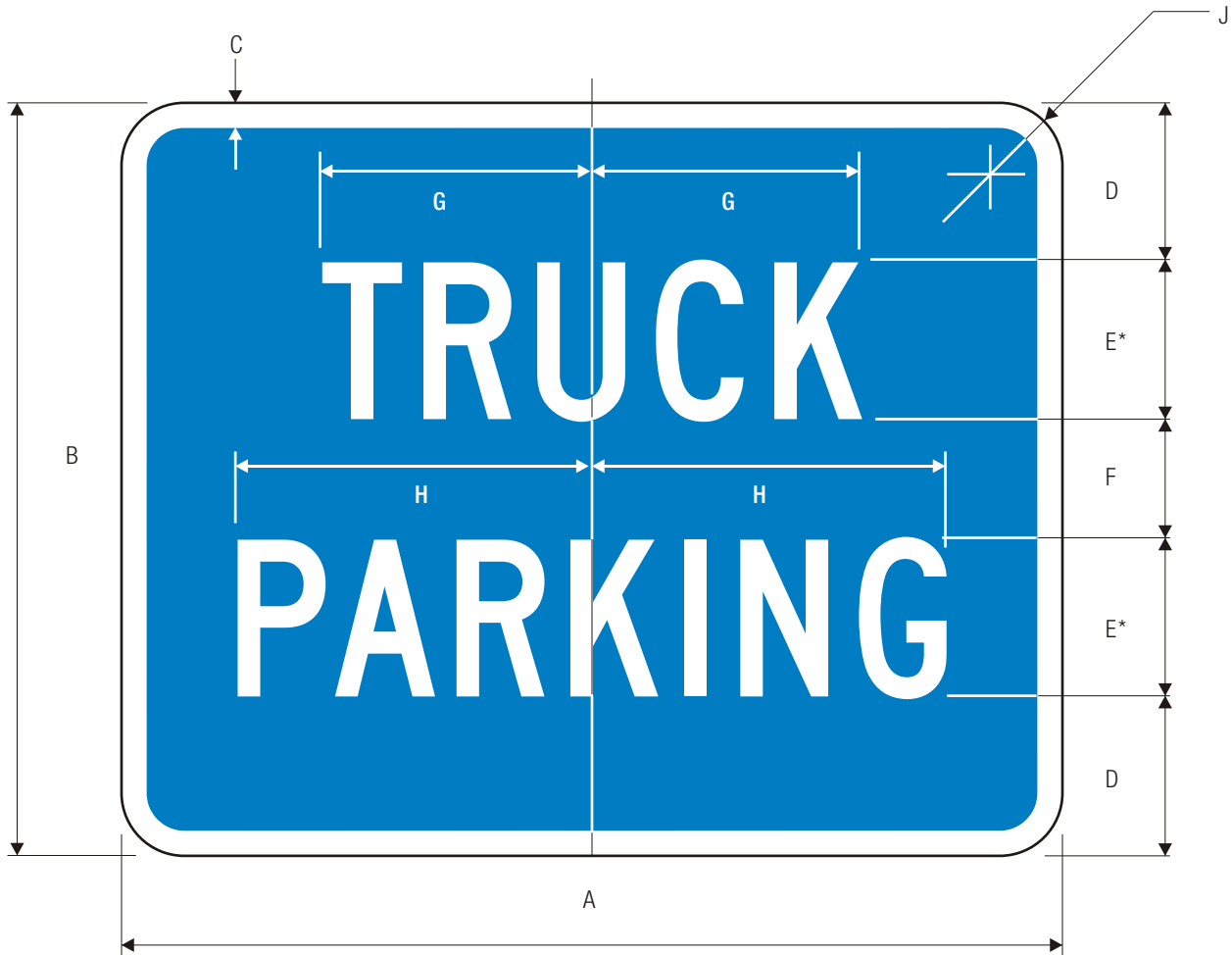

D9-16

TRUCK PARKING

*Series 2000 Standard Alphabets.

A	B	C	D	E	F	G	H	J
24	18	.5	3.5	4 C	3	6.885	9.046	1.5
30	24	.75	5.125	5 C	3.75	8.606	11.308	1.875

COLORS: LEGEND WHITE (RETROREFLECTIVE)
 BACKGROUND BLUE (RETROREFLECTIVE)

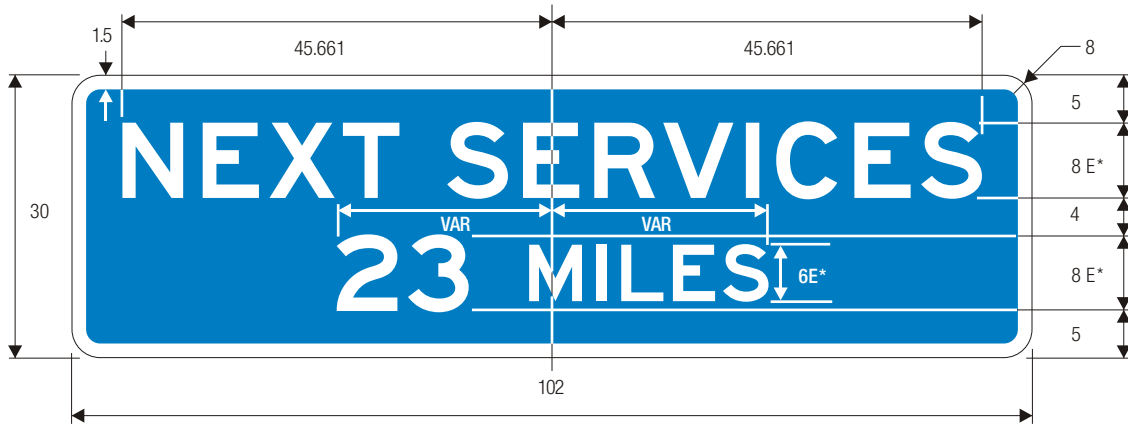

D9-17

NEXT SERVICES XX MILES (ENGLISH)

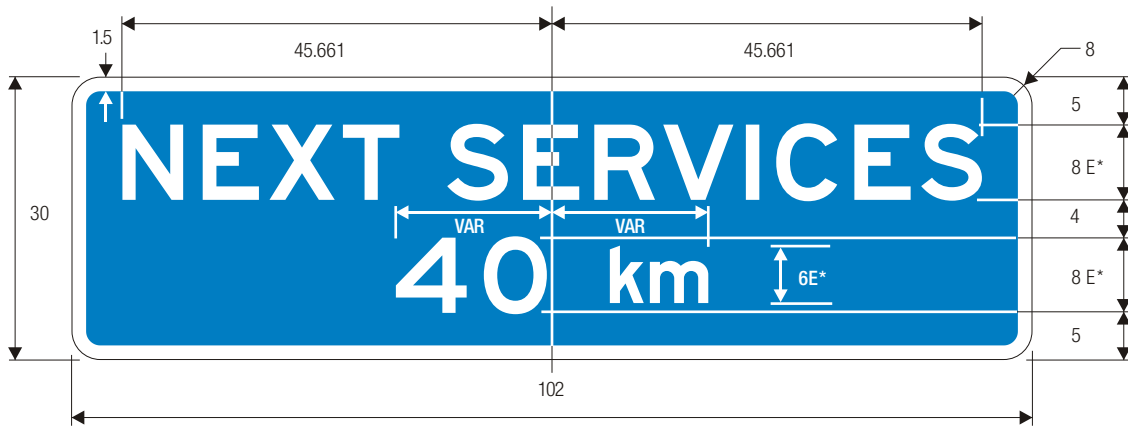

D9-17

NEXT SERVICES XX km (METRIC)

*Series 2000 Standard Alphabets.

COLORS: LEGEND WHITE (RETROREFLECTIVE)
 BACKGROUND BLUE (RETROREFLECTIVE)

MOTORIST SERVICES SIGN

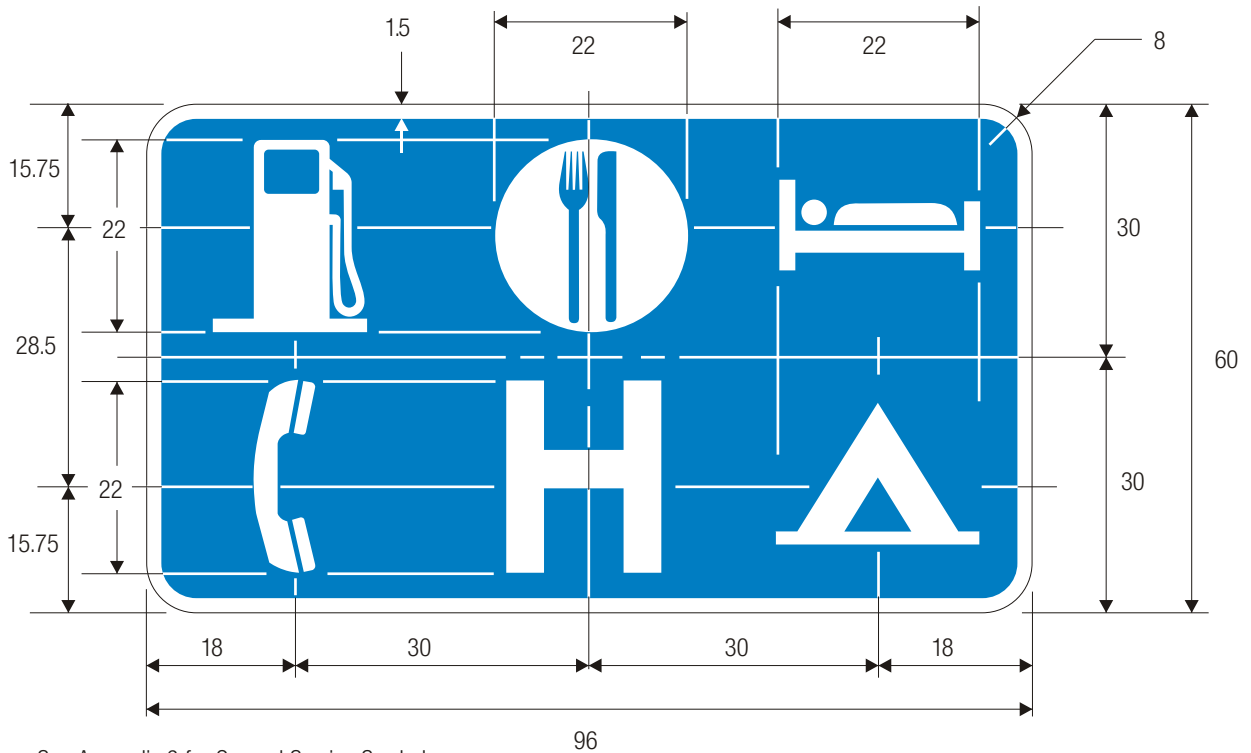

See Appendix 6 for General Service Symbols

D9-18

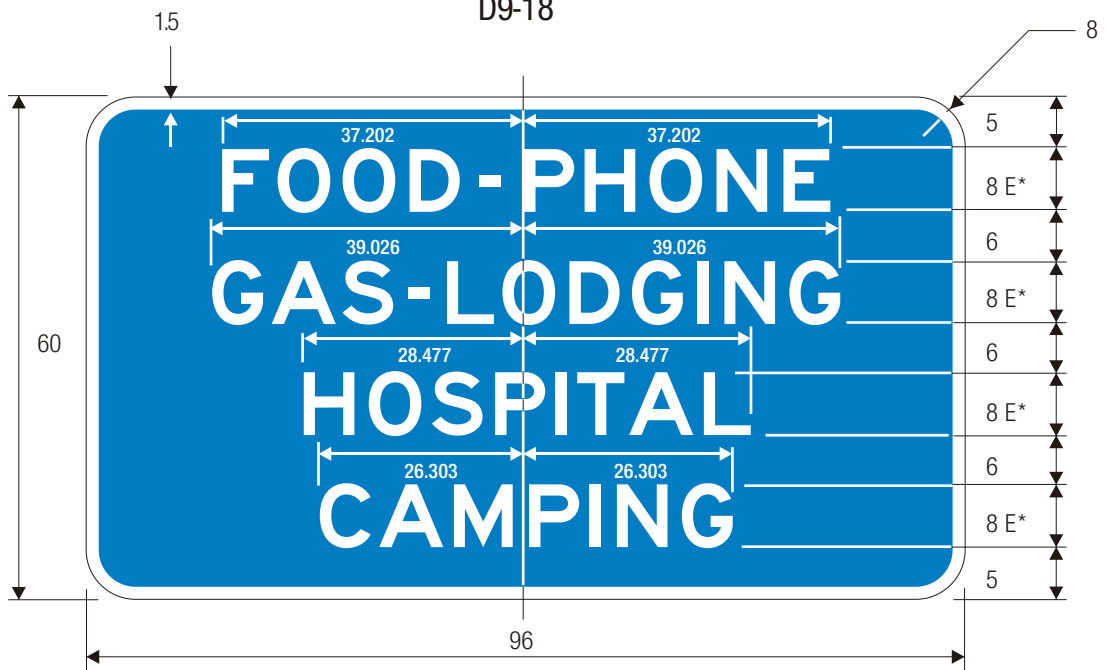

D9-18a

*Series 2000 Standard Alphabets.

COLORS: LEGEND — WHITE (RETROREFLECTIVE)
BACKGROUND— BLUE (RETROREFLECTIVE)

MOTORIST SERVICES SIGN

04/14/05



D9-18e

*Series 2000 Standard Alphabets.

COLORS: LEGEND — WHITE (RETROREFLECTIVE)
BACKGROUND — BLUE (RETROREFLECTIVE)

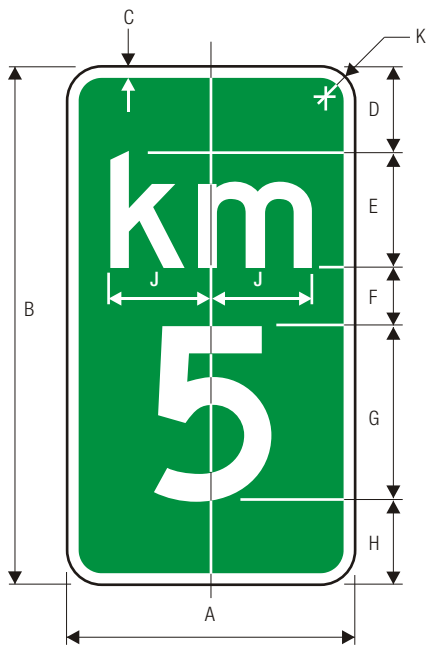

D10-1

A	B	C	D
10	18	.5	3
12	24	.5	3.5

E	F	G	H
4 D	2	6 D	3
4 D	3	10 D	3.5

J	K	L
3.502	1.5	3.922
3.502	1.5	3.922

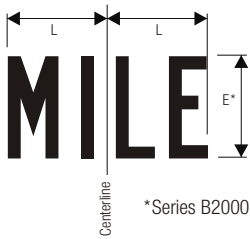

*Series B2000

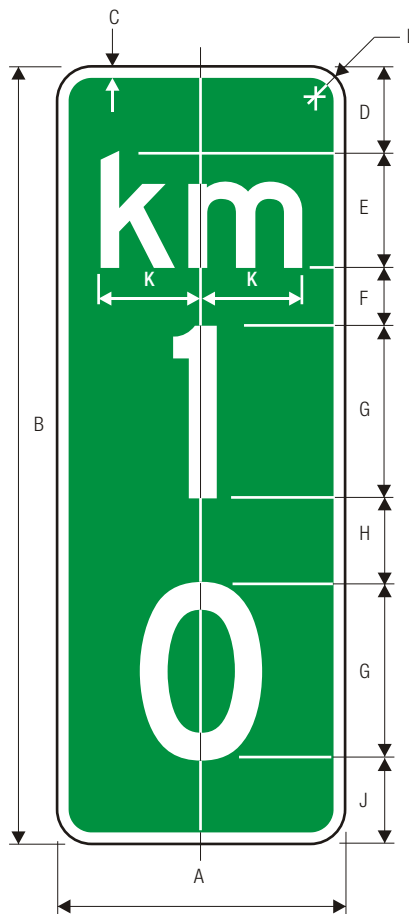

D10-2

A	B	C	D
10	27	.5	3
12	36	.5	3

E	F	G	H
4 D	2	6 D	3
4 D	3	10 D	3

J	K	L	M
3	3.502	1.5	3.922
3	3.502	1.5	3.922



*Series B2000

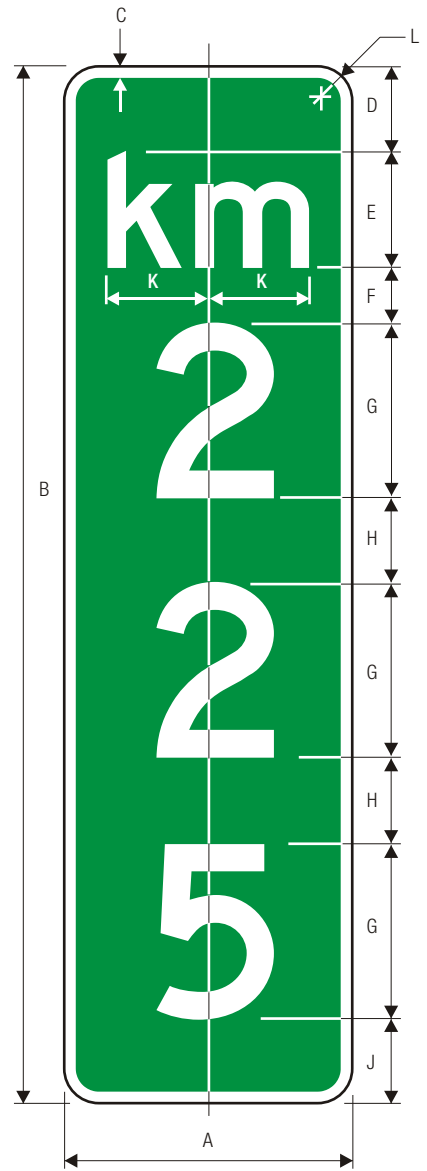

D10-3

A	B	C	D
10	36	.5	3
12	48	.5	3

E	F	G	H
4 D	2	6 D	3
4 D	3	10 D	2.5

J	K	L	M
3	3.502	1.5	3.922
3	3.502	1.5	3.922



*Series B2000

Optically locate numerals about centerline.

REFERENCE LOCATION SIGNS

COLORS: LEGEND —WHITE (RETROREFLECTIVE)
 BACKGROUND —GREEN (RETROREFLECTIVE)

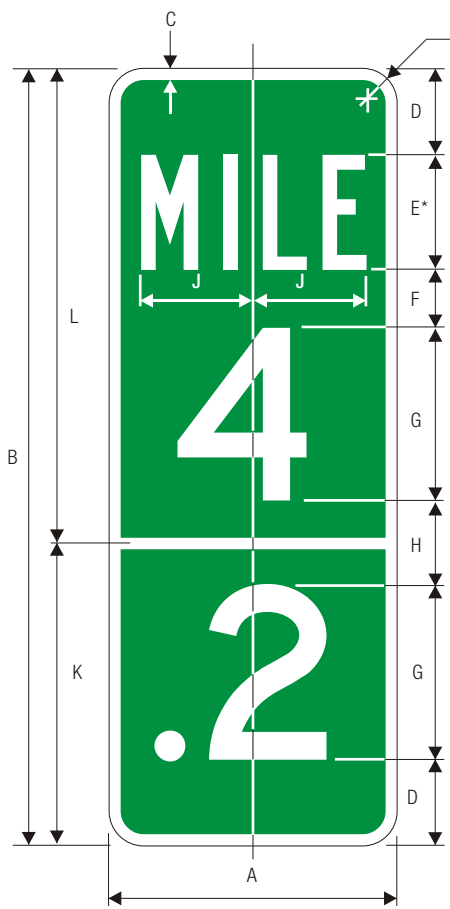

D10-1a

A	B	C	D
10	27	.5	3
12	36	.5	3
E	F	G	H
4 B	2	6 D	3
4 B	3	10 D	3
J	K	L	M
3.922	10.5	16.5	1.5
3.922	14.5	21.5	1.5

INTERMEDIATE REFERENCE LOCATION SIGNS

*Series 2000 Standard Alphabets.
Optically locate numerals about centerline.

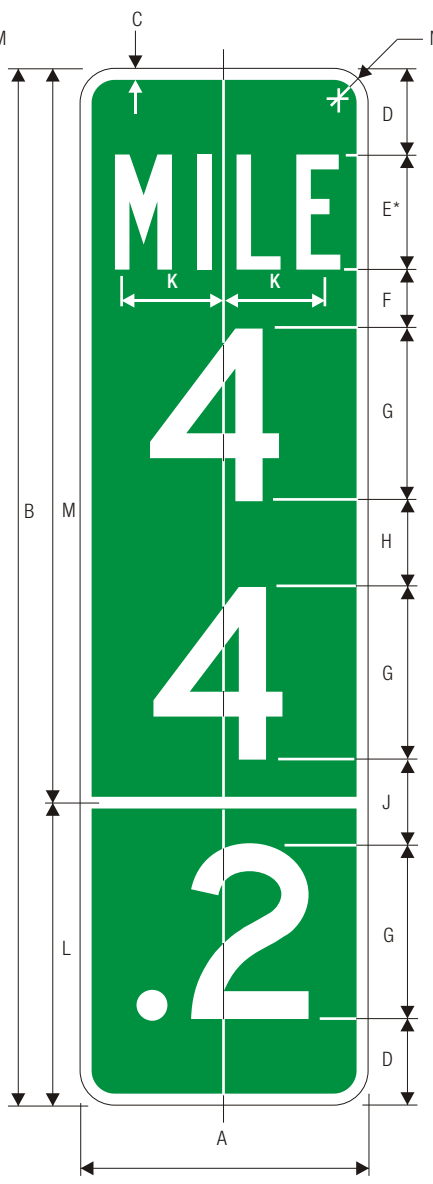

D10-2a

INTERMEDIATE REFERENCE LOCATION SIGNS

A	B	C	D
10	36	.5	3
12	48	.5	2
E	F	G	H
4 B	2	6 D	3
4 B	3	10 D	3
J	K	L	M
3	3.922	10.5	25.5
4	3.922	14	34
N			
1.5			
1.5			

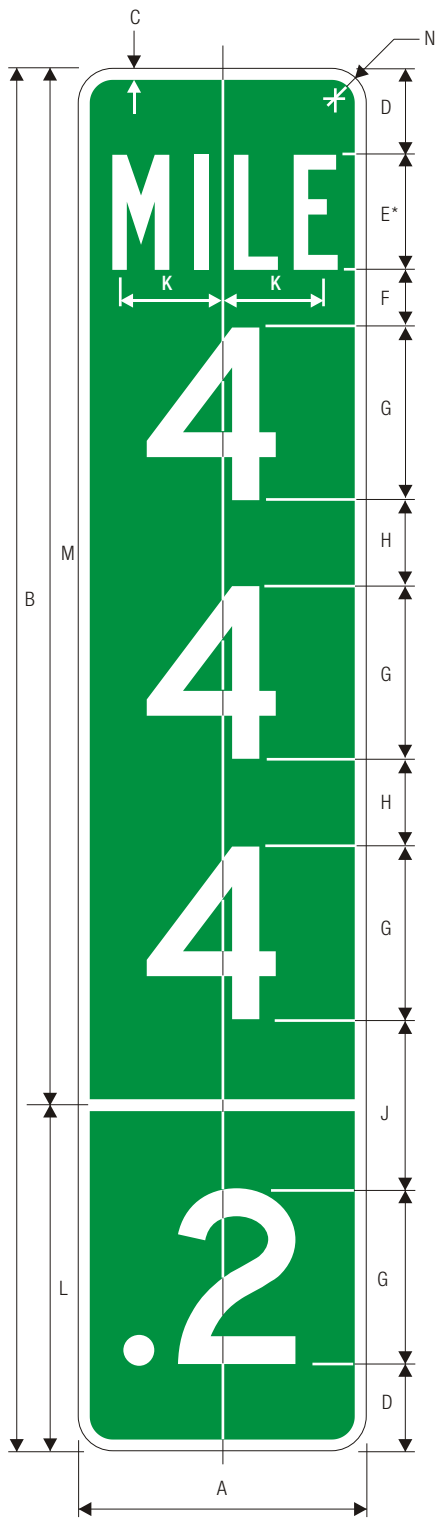

D10-3a

A	B	C	D	
10	48	.5	3	
12	60	.5	2	
E	F	G	H	
4 B	2	6 D	3	
4 B	3	10 D	2	
J	K	L	M	N
6	3.922	12	36	1.5
5	3.922	14.5	45.5	1.5

COLORS: LEGEND —WHITE (RETROREFLECTIVE)
BACKGROUND —GREEN (RETROREFLECTIVE)

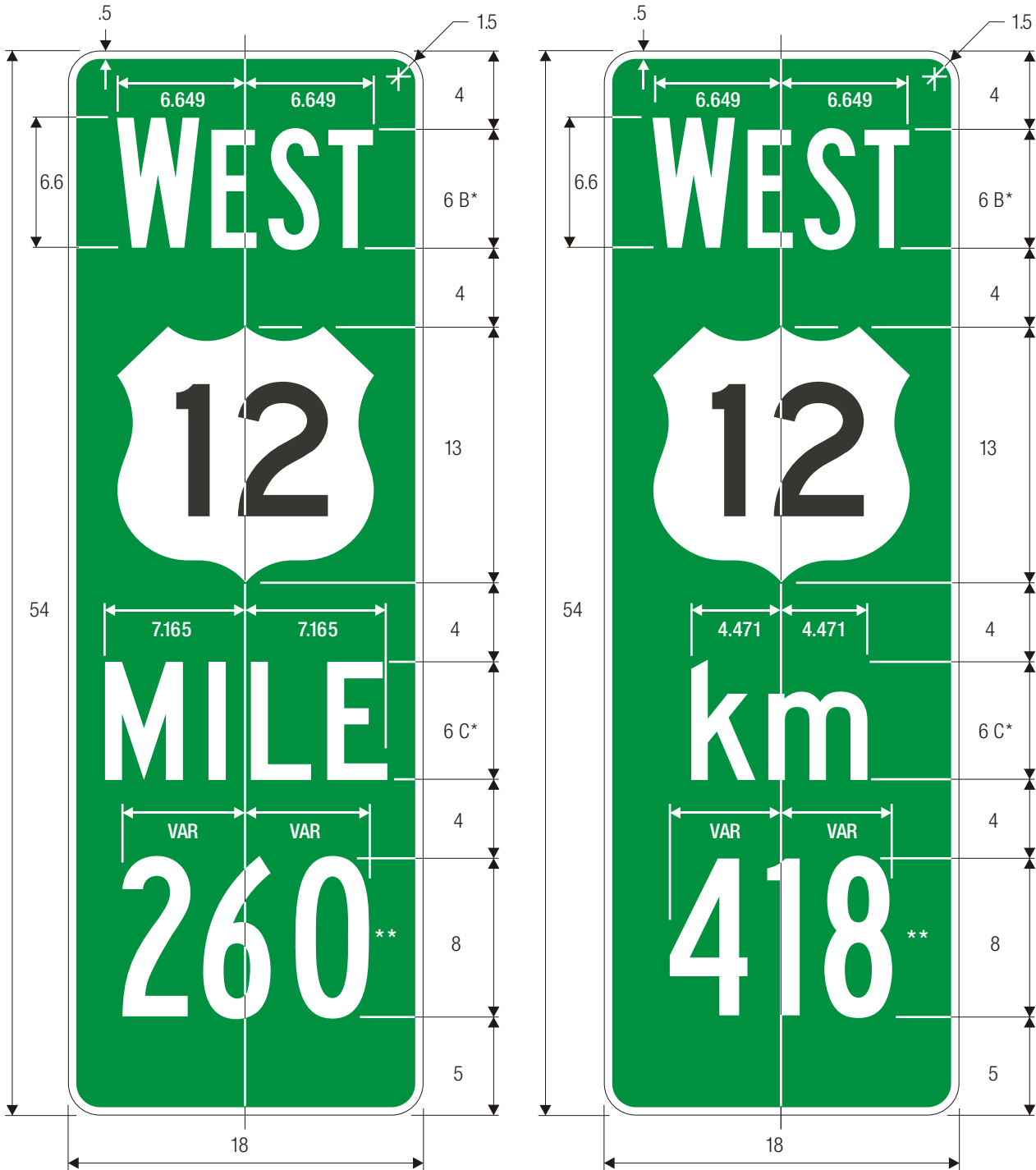

D10-4

ENHANCED REFERENCE LOCATION SIGNS

*Series 2000 Standard Alphabets.

**Optically locate numerals about centerline.

COLORS: LEGEND —WHITE (RETROREFLECTIVE)
 BACKGROUND —GREEN OR BLUE (RETROREFLECTIVE)

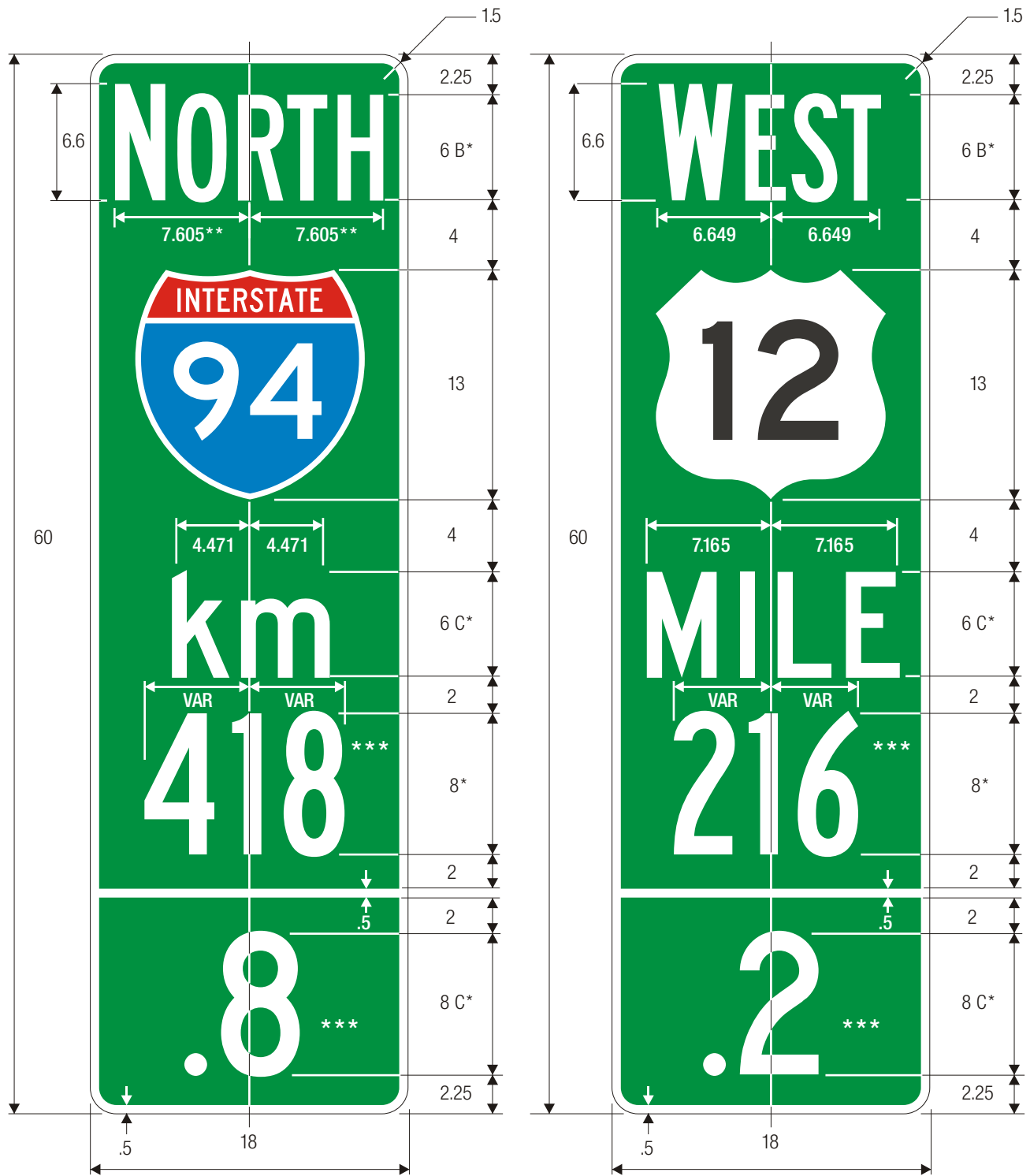

D10-5

INTERMEDIATE ENHANCED REFERENCE LOCATION

- *Series 2000 Standard Alphabets.
- **Reduce spacing to fit.
- ***Optically locate numerals about centerline.

COLORS: LEGEND —WHITE (RETROREFLECTIVE)
 BACKGROUND —GREEN OR BLUE (RETROREFLECTIVE)

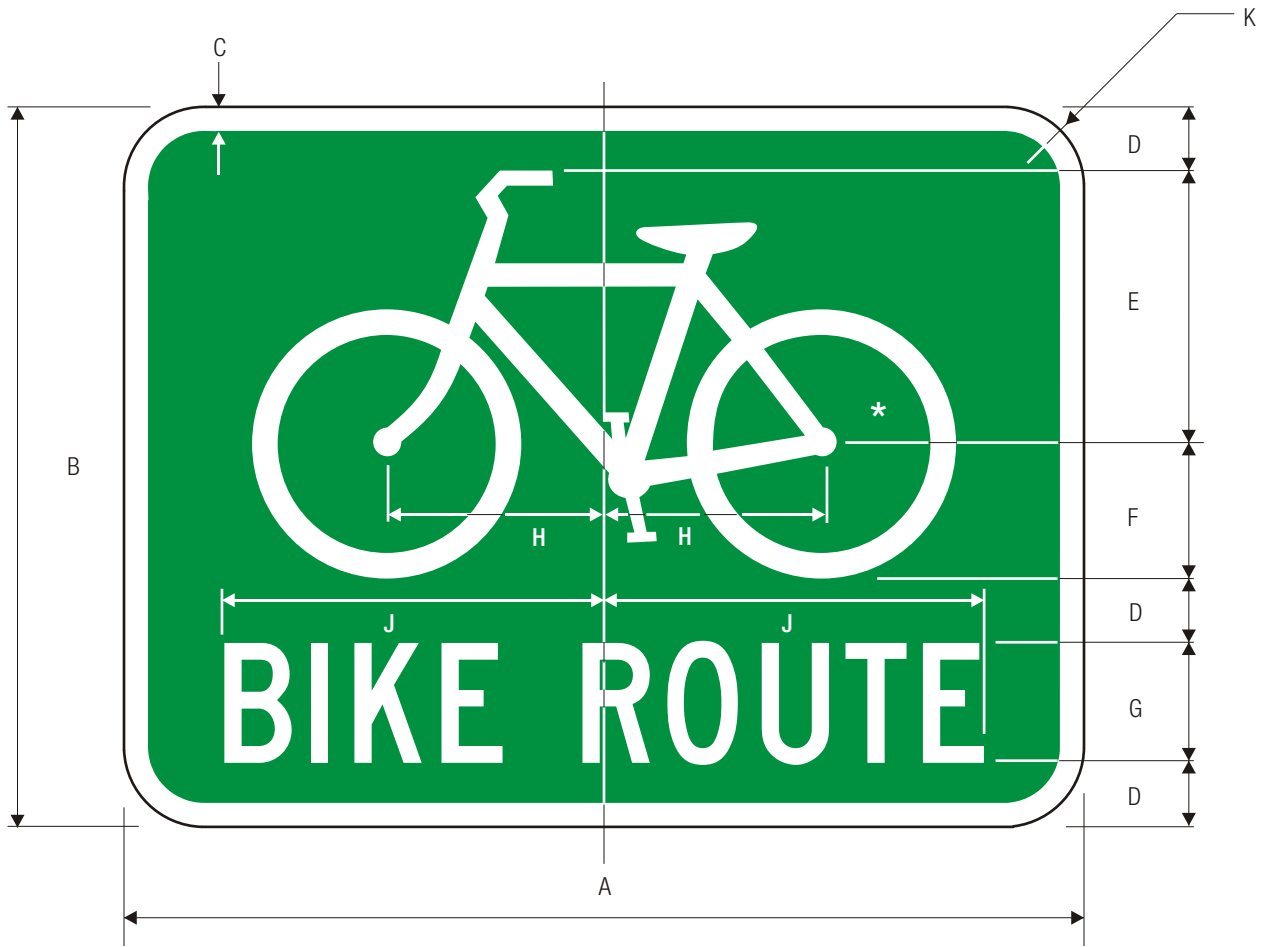

D11-1
BICYCLE ROUTE

*See page 6-7 for symbol design.

A	B	C	D	E	F	G	H	J	K
24	18	.5	1.5	7	3.5	3 C	5.5	9.5	1.5
30	24	.625	1.875	8.75	4.375	4 C	6.875	12.5	1.5

COLORS: LEGEND WHITE (RETROREFLECTIVE)
 SYMBOL WHITE (RETROREFLECTIVE)
 BACKGROUND GREEN (RETROREFLECTIVE)

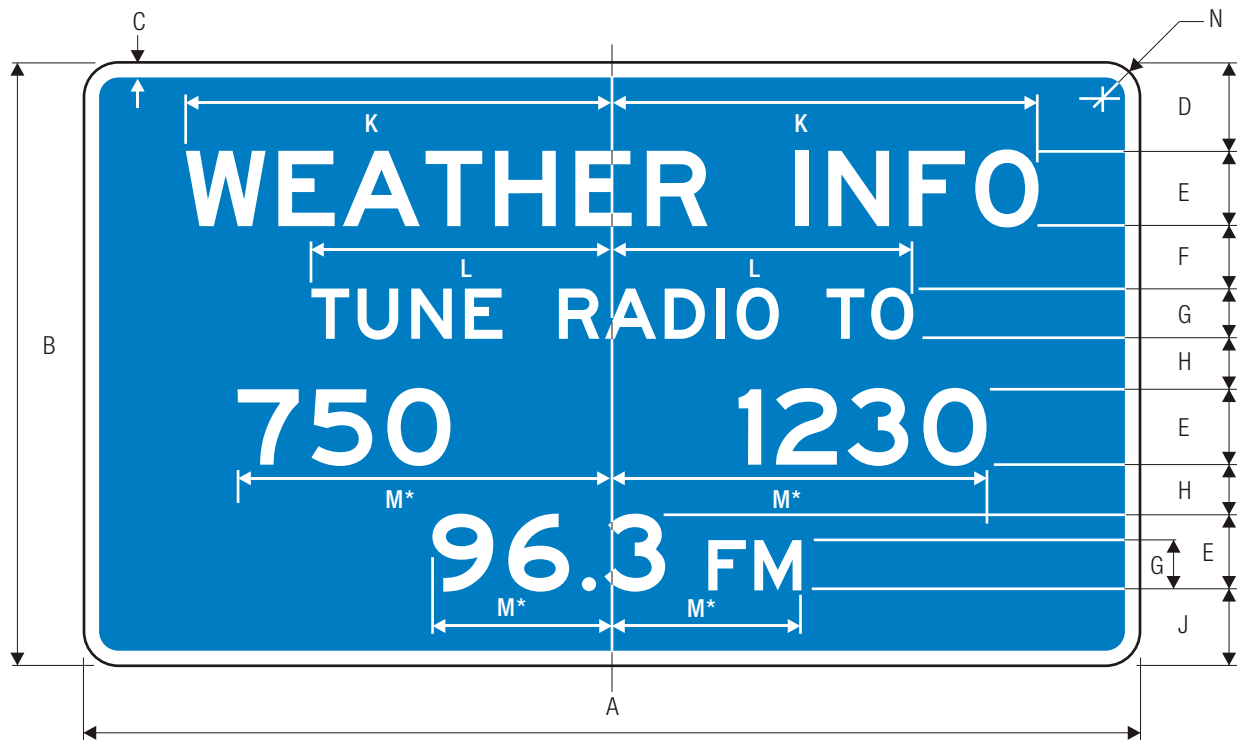

D12-1
WEATHER INFO

*Optically space characters about vertical centerline.

A	B	C	D	E	F	G	H	J	K	L	M	N
84	48	1.5	7	6 E	5	4 E	4	6	33.5	24	VAR	3
108	66	2	9	8 E	7	6 E	6	8	44.75	36	VAR	4
132	84	2	11	10 E	9	8 E	8	10	55.875	48	VAR	5

COLORS: LEGEND —WHITE (RETROREFLECTIVE)
BACKGROUND —BLUE (RETROREFLECTIVE)

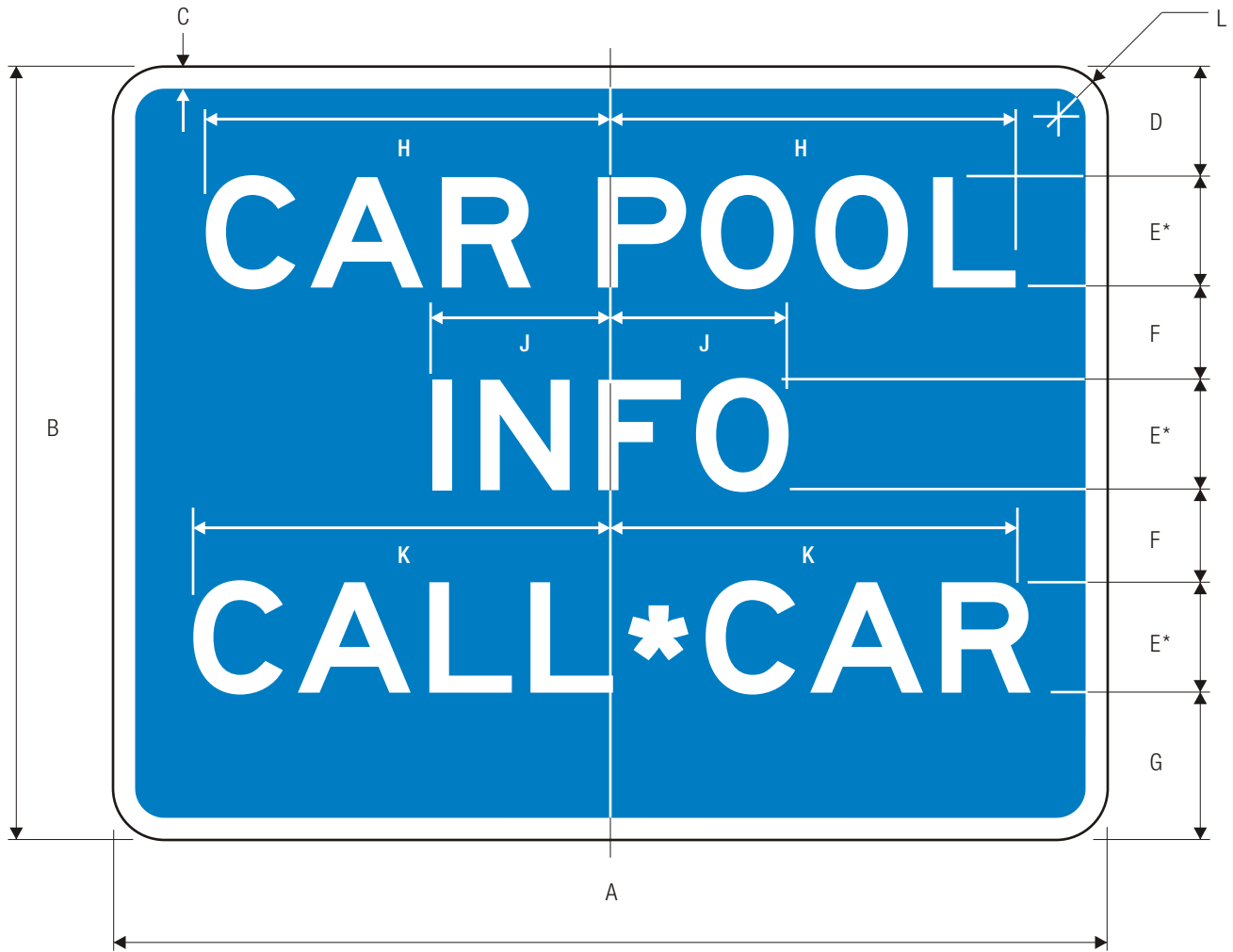

D12-2

CAR POOL INFORMATION

*Series 2000 Standard Alphabets.

A	B	C	D	E	F	G	H	J	K	L
54	42	.75	6	6 E	5	8	22.342	9.667	22.752	1.25
72	54	1.25	8	8 E	6	10	29.795	12.891	30.342	1.75
96	66	2	9	10 E	8	11	37.241	16.113	37.925	2.5

COLORS: LEGEND —WHITE (RETROREFLECTIVE)
 BACKGROUND —BLUE (RETROREFLECTIVE)

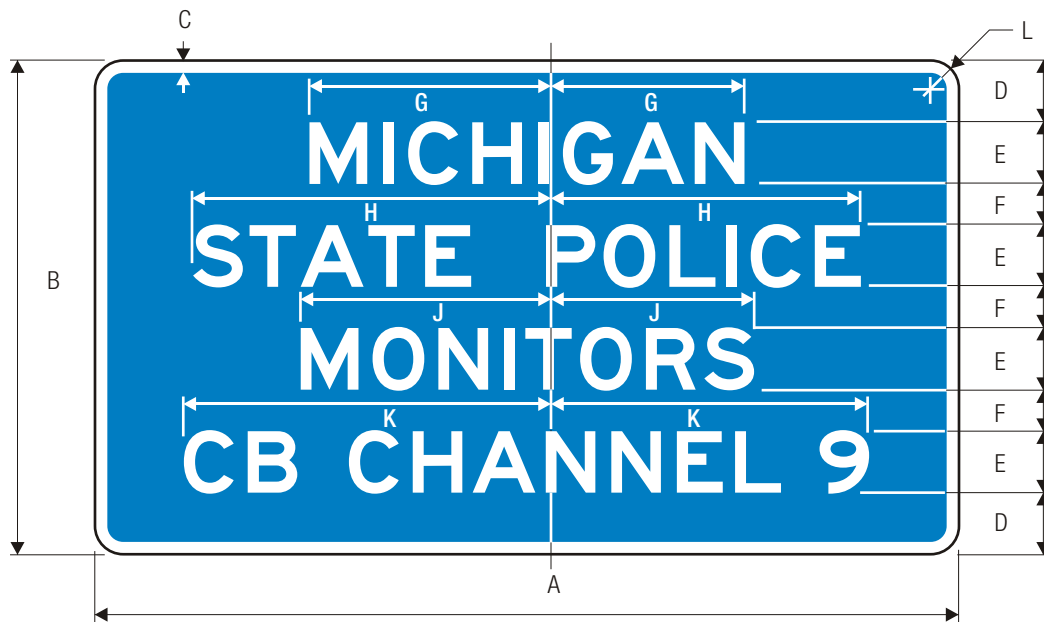

D12-3

CHANNEL 9 MONITORED

A	B	C	D	E	F	G	H	J	K	L
84	48	1.5	6	6 E	4	21.5	33.5	23	35	3
108	66	2	8	8 E	6	28.5	43	30.5	46.5	4
132	84	2	10	10 E	8	35.5	53.5	38	58	5

COLORS: LEGEND —WHITE (RETROREFLECTIVE)
 BACKGROUND —BLUE (RETROREFLECTIVE)



D12-4

EMERGENCY DIAL 911

*Series 2000 Standard Alphabets.

A	B	C	D	E	F	G	H	J
64	30	.75	6.5	6 E	5	27.153	17.232	1.25
72	36	1.25	8	7 E	6	31.682	20.107	1.75
96	48	2	11	9 E	8	40.730	25.849	2.5

COLORS: LEGEND —WHITE (RETROREFLECTIVE)
 BACKGROUND —BLUE (RETROREFLECTIVE)

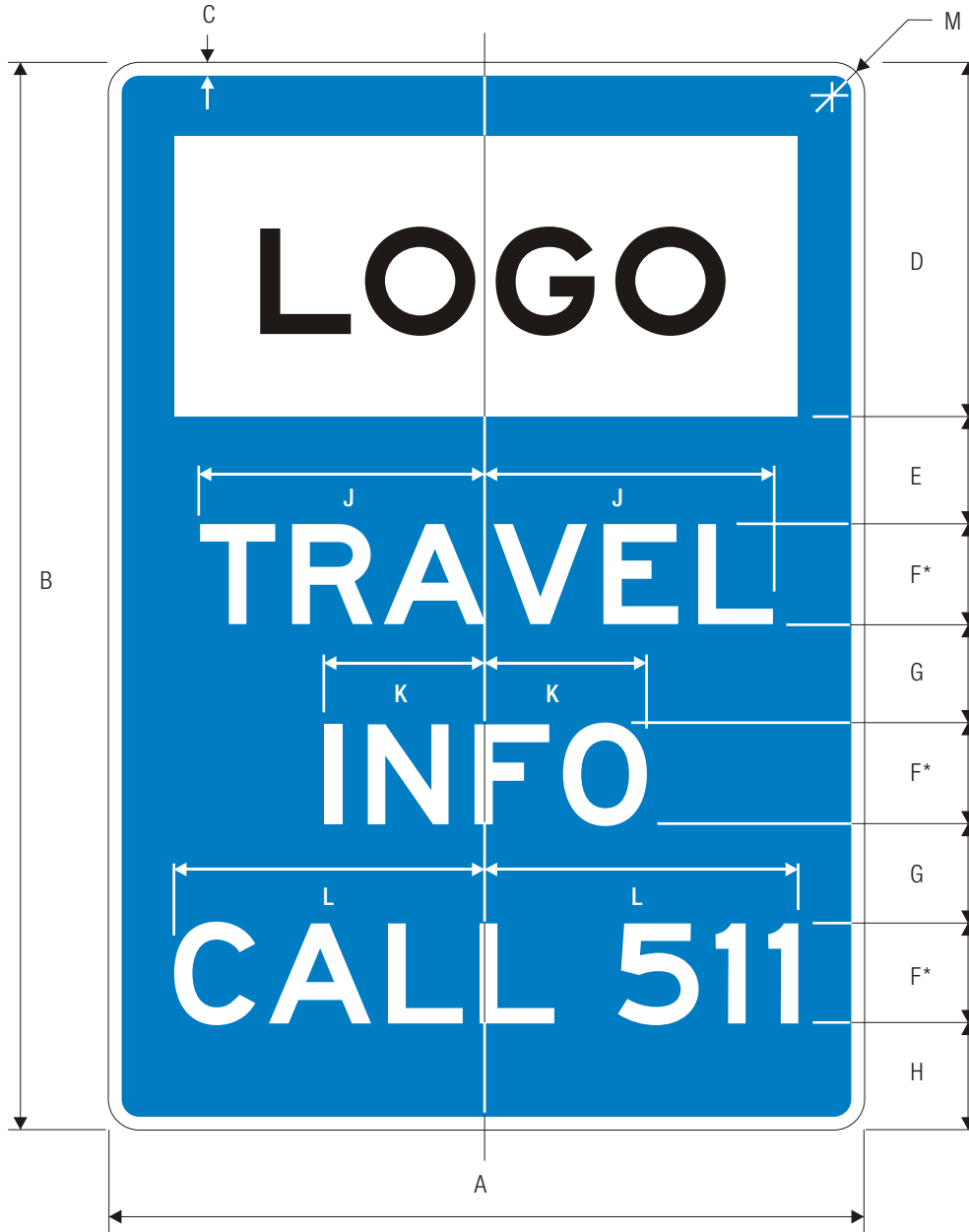

D12-5

TRAVEL INFO CALL 511

*Series 2000 Standard Alphabets.

A	B	C	D	E	F	G	H	J	K	L	M
42	60	.75	20	7.5	5 E	5	7.5	14.310	8.066	15.591	2.25
54	80	1	27	9	7 E	7	9	20.055	11.288	21.836	3
68	96	1	32	9.5	9 E	9	9.5	25.779	14.511	28.081	3

COLORS: LEGEND —WHITE (RETROREFLECTIVE)
 BACKGROUND —BLUE (RETROREFLECTIVE)

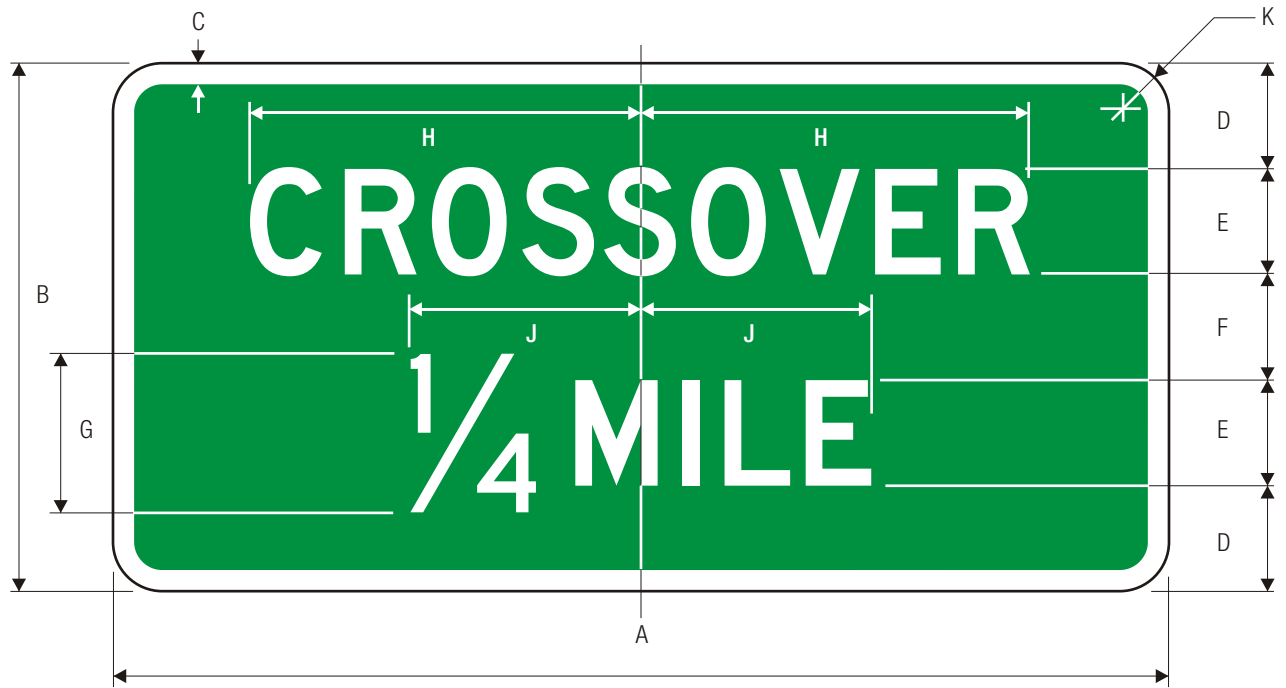

D13-2
CROSSOVER

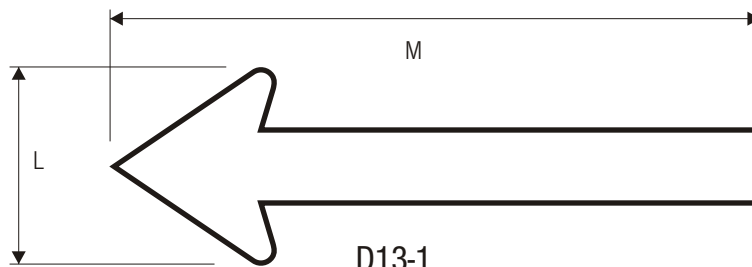

D13-1
CROSSOVER

Use arrow at crossover location.

A	B	C	D	E	F	G	H	J	K	L	M
60	30	.75	6	6 D	6	9	23	13.5	1.875	6	18
72	36	1	7	8 D	6	12	30.625	18	2	8	24

COLORS: LEGEND —WHITE (RETROREFLECTIVE)
BACKGROUND —GREEN (RETROREFLECTIVE)



D13-3

FREEWAY ENTRANCE

*Series 2000 Standard Alphabets.
 **Reduce spacing to fit.

COLORS: LEGEND WHITE (RETROREFLECTIVE)
 BACKGROUND GREEN (RETROREFLECTIVE)

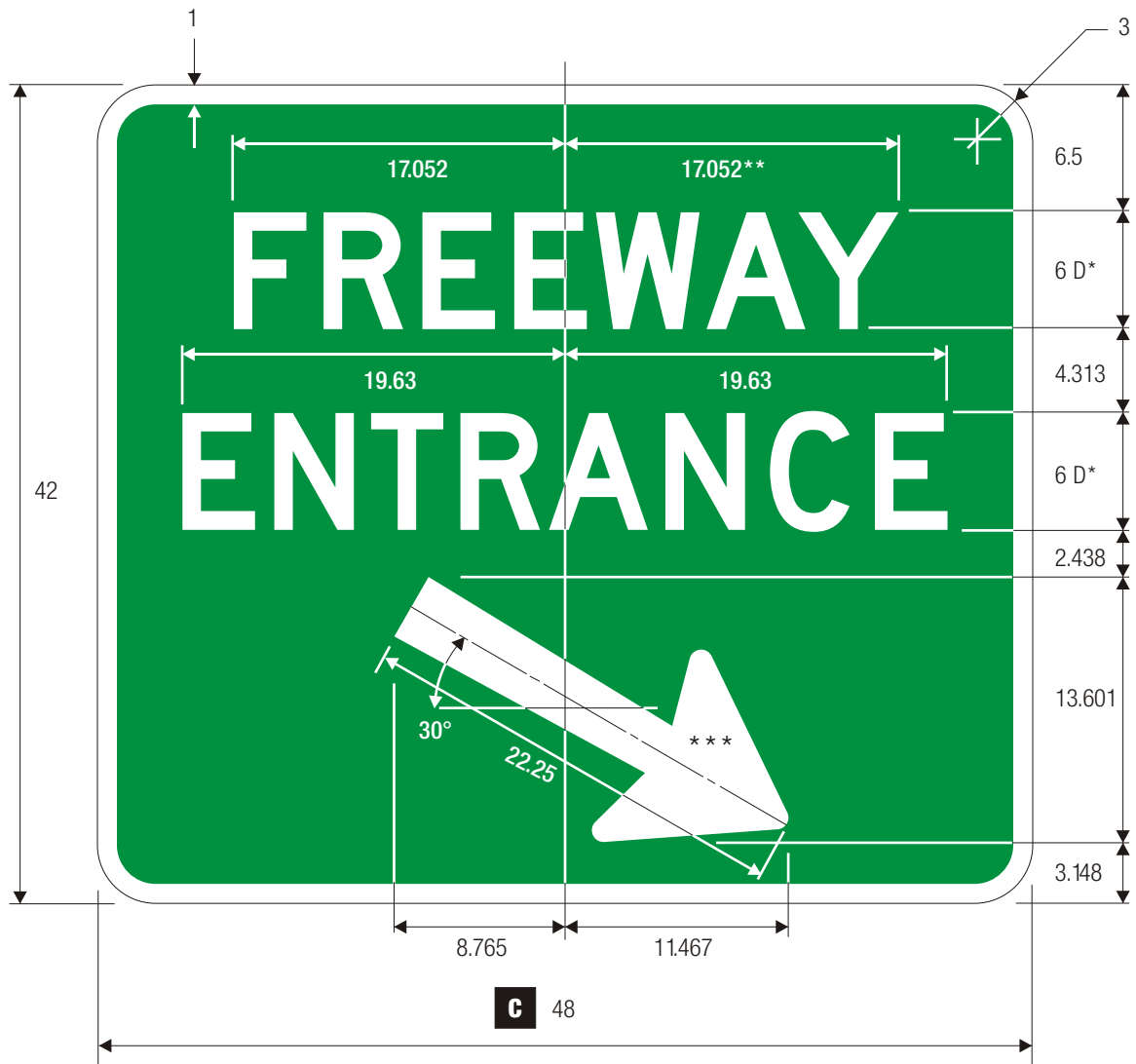

D13-3aR

FREEWAY ENTRANCE

*Series 2000 Standard Alphabets.
 **Reduce spacing to fit.
 ***See page 6-3 for design details.



D13-3aL

COLORS: LEGEND WHITE (RETROREFLECTIVE)
 SYMBOL WHITE (RETROREFLECTIVE)
 BACKGROUND GREEN (RETROREFLECTIVE)

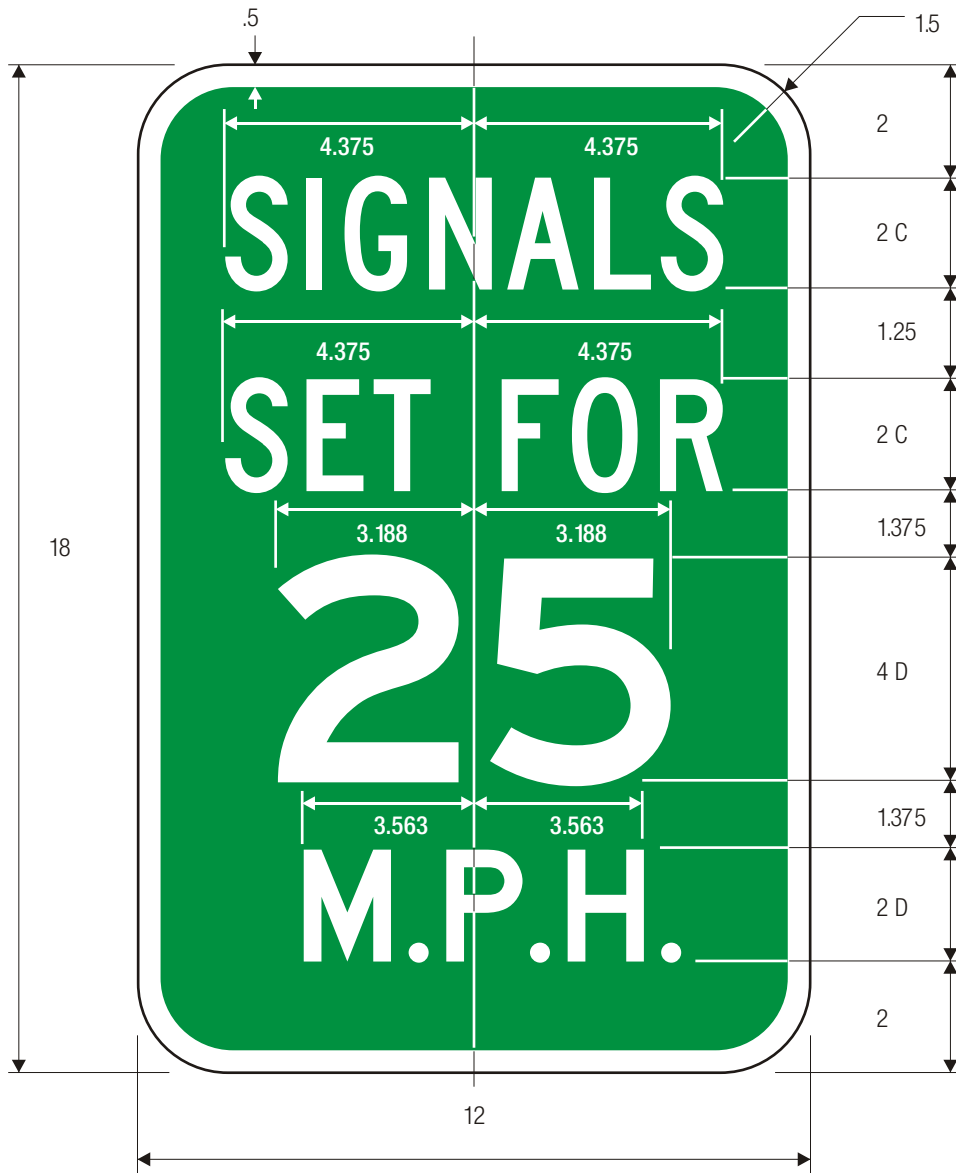

I1-1

TRAFFIC SIGNAL SPEED

COLORS: LEGEND WHITE (RETROREFLECTIVE)
 BACKGROUND GREEN (RETROREFLECTIVE)

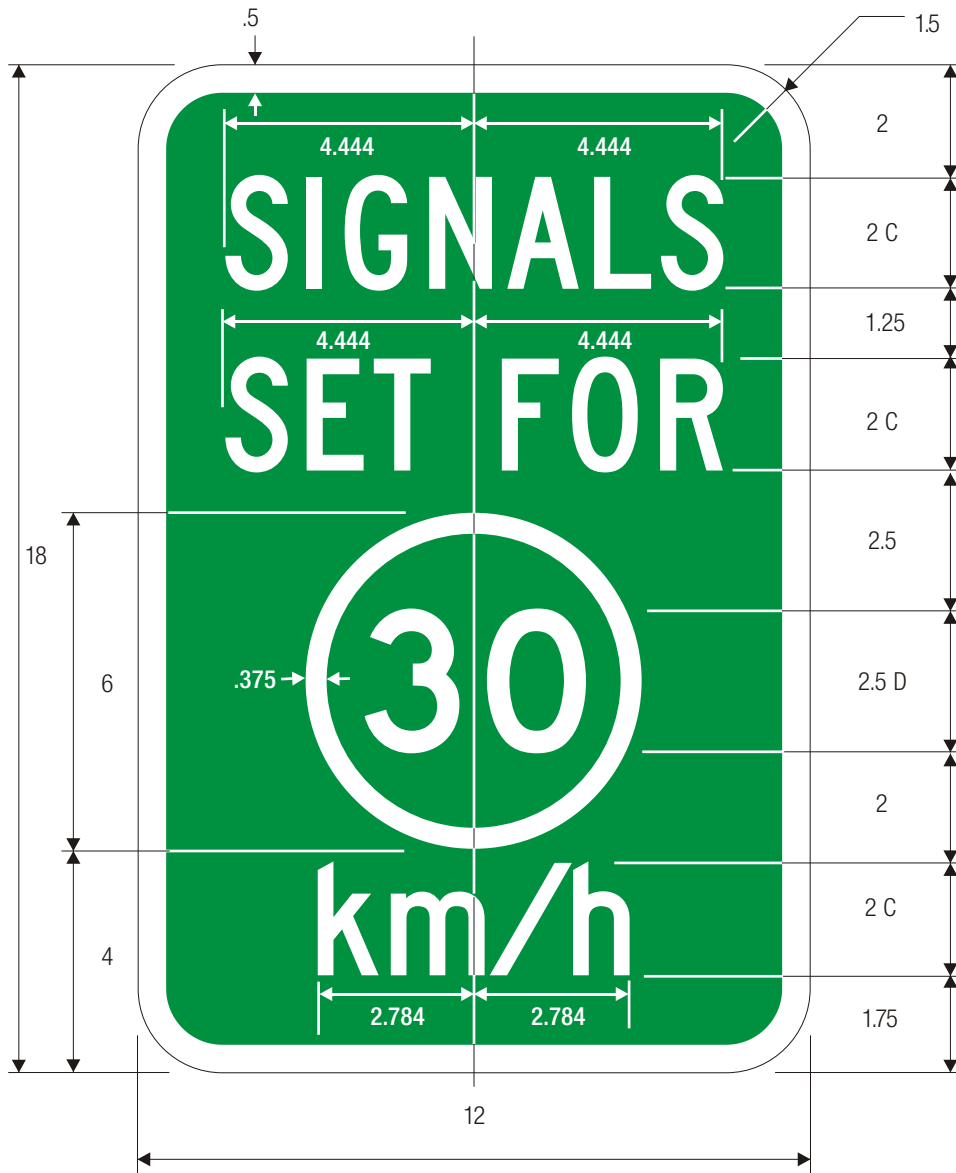

I1-1

TRAFFIC SIGNAL SPEED (METRIC)

COLORS: LEGEND WHITE (RETROREFLECTIVE)
 BACKGROUND GREEN (RETROREFLECTIVE)

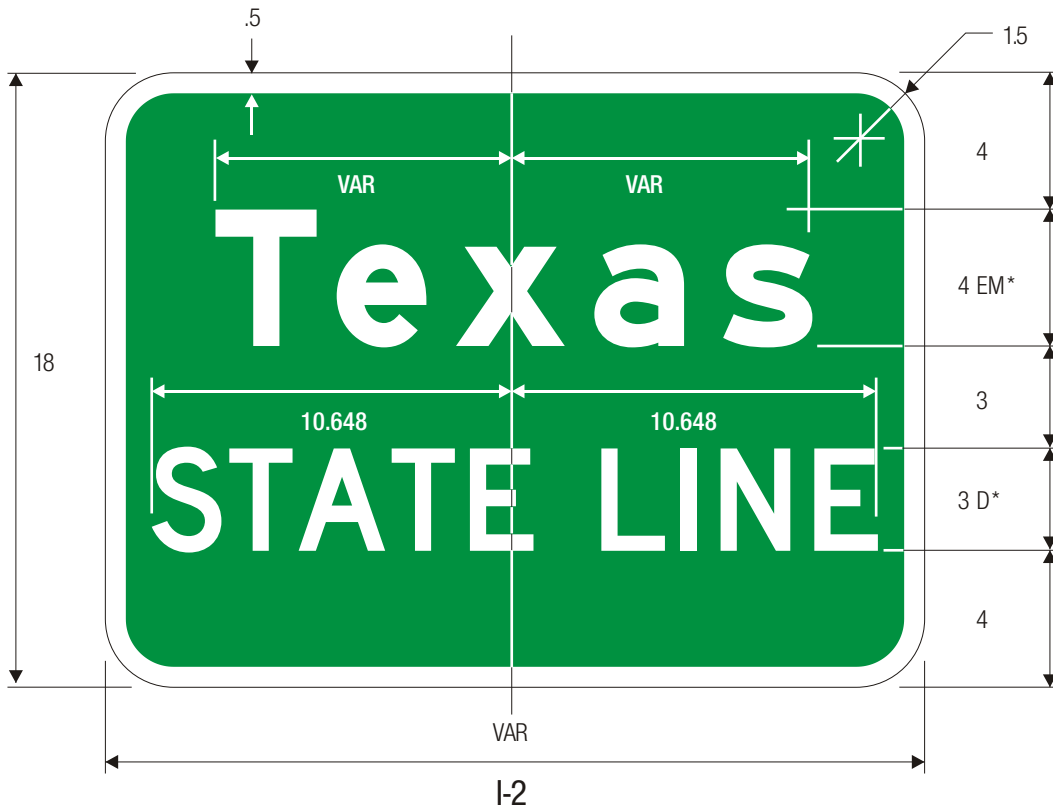

I-2
STATE LINE

*Series 2000 Standard Alphabets.

COLORS: LEGEND WHITE (RETROREFLECTIVE)
 BACKGROUND GREEN (RETROREFLECTIVE)



COLORS: LEGEND WHITE (RETROREFLECTIVE)
 BACKGROUND GREEN (RETROREFLECTIVE)

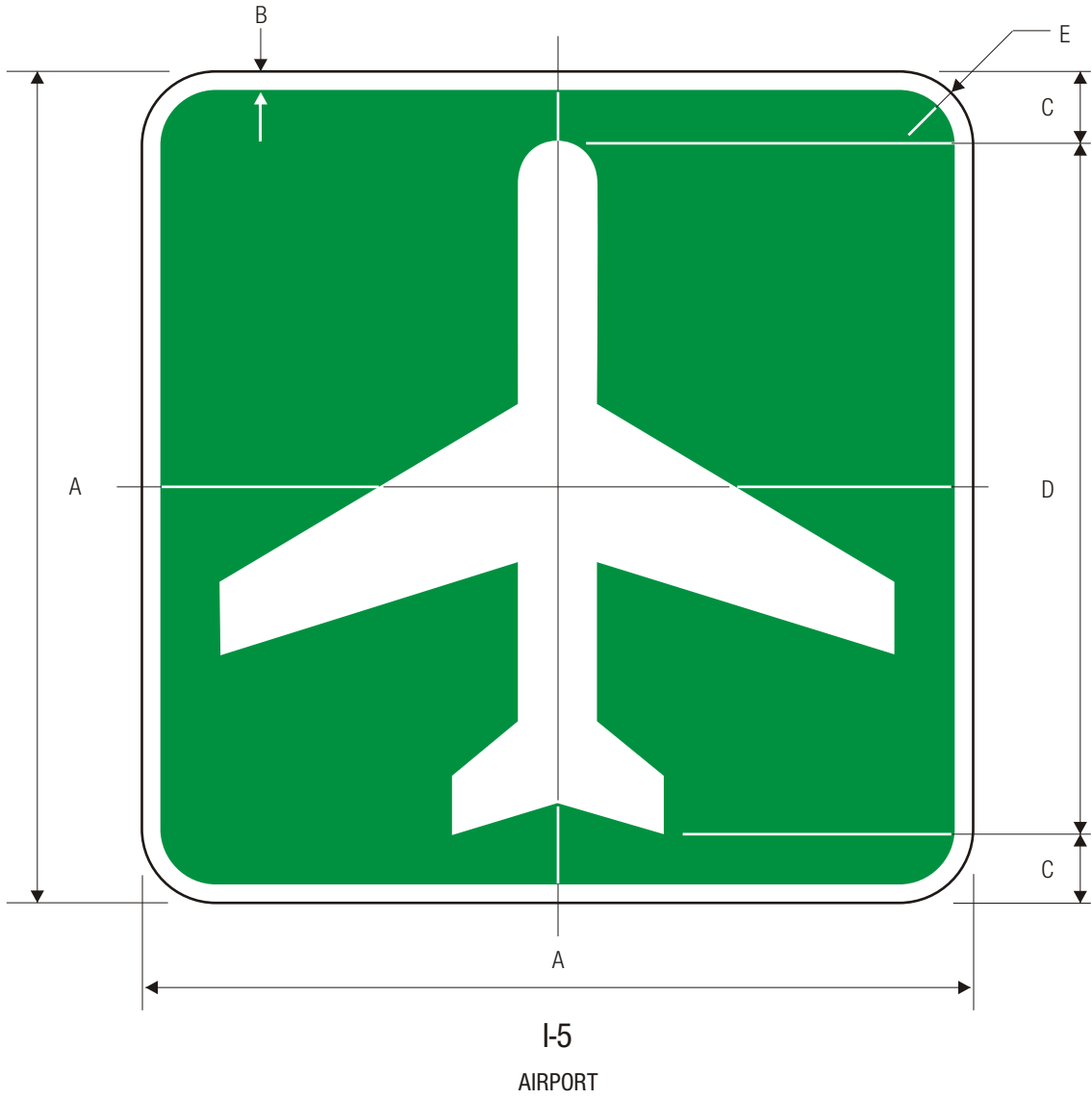

*See page 6-53 for symbol design.

A	B	C	D	E
18	.5	1.5	15	1.5
24	.5	2	20	1.5
30	.75	2.5	25	1.875

COLORS: SYMBOL WHITE (RETROREFLECTIVE)
BACKGROUND GREEN (RETROREFLECTIVE)

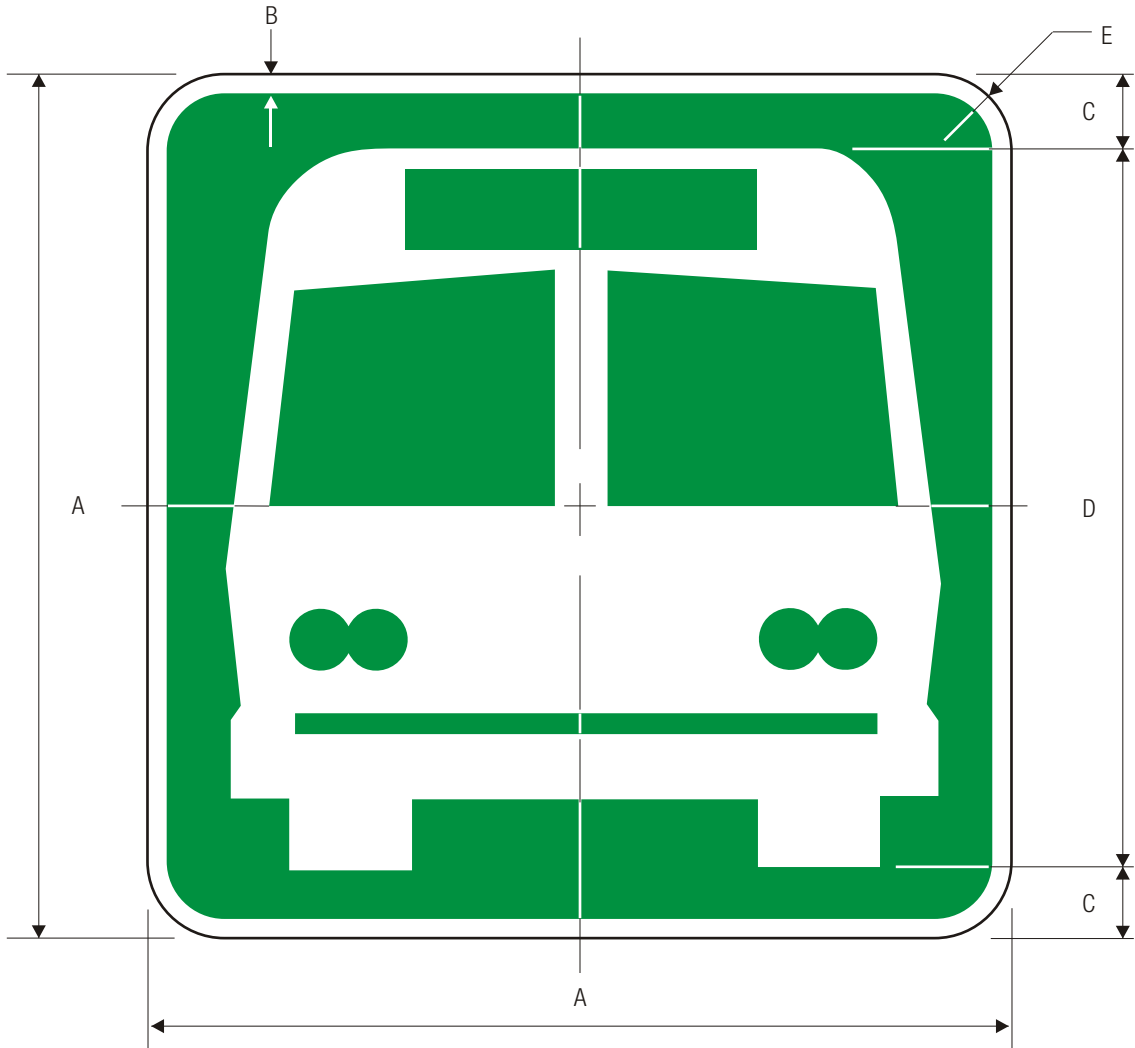

I-6
BUS STATION

*See page 6-33 for symbol design.

A	B	C	D	E
18	.5	1.5	15	1.5
24	.5	2	20	1.5
30	.75	2.5	25	1.875

COLORS: SYMBOL WHITE (RETROREFLECTIVE)
BACKGROUND GREEN (RETROREFLECTIVE)

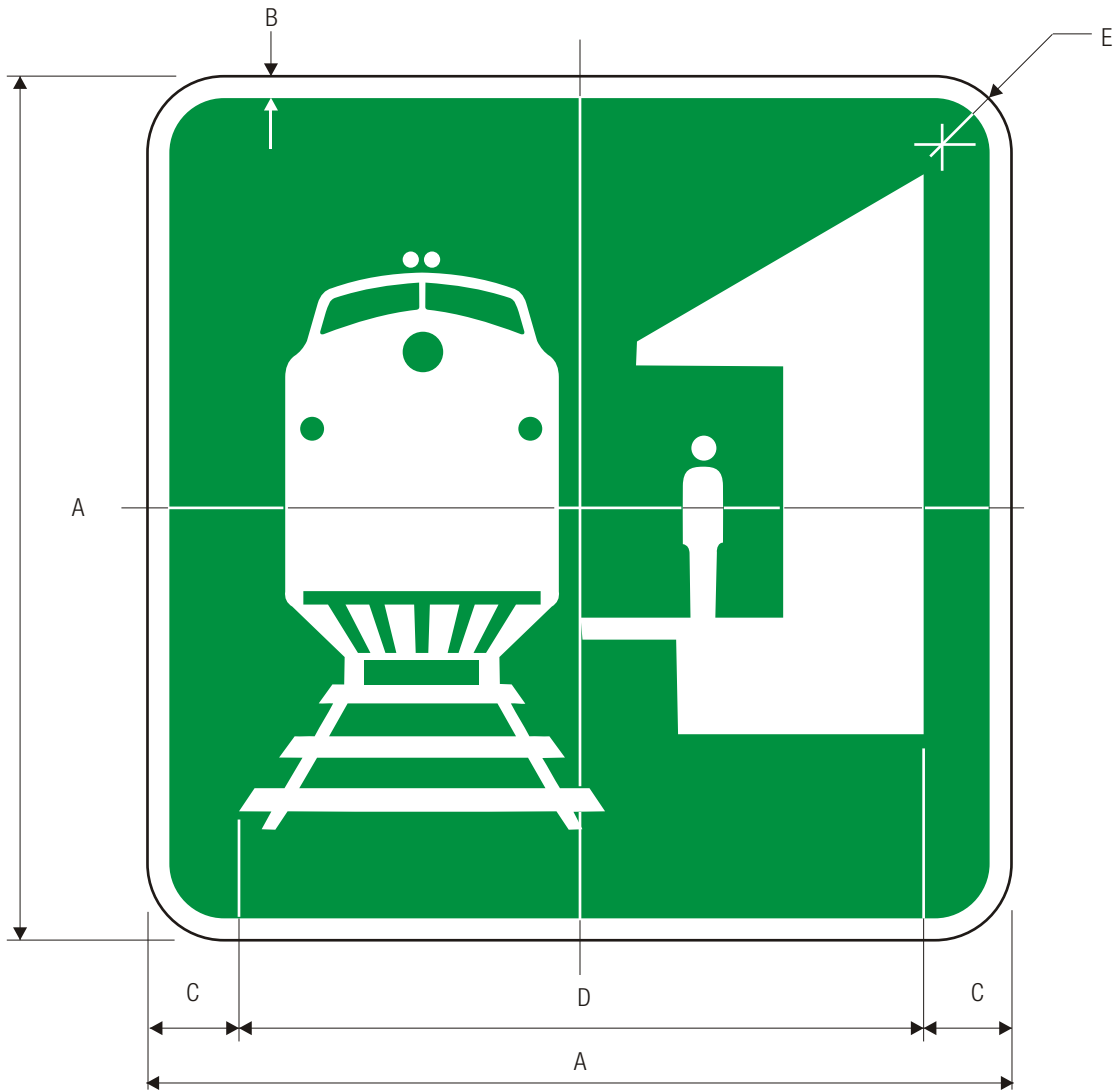

I-7
TRAIN STATION

*See page 6-54 for symbol design.

A	B	C	D	E
18	.5	1.5	15	1.5
24	.5	2	20	1.5
30	.75	2.5	25	1.875

COLORS: SYMBOL WHITE (RETROREFLECTIVE)
BACKGROUND GREEN (RETROREFLECTIVE)

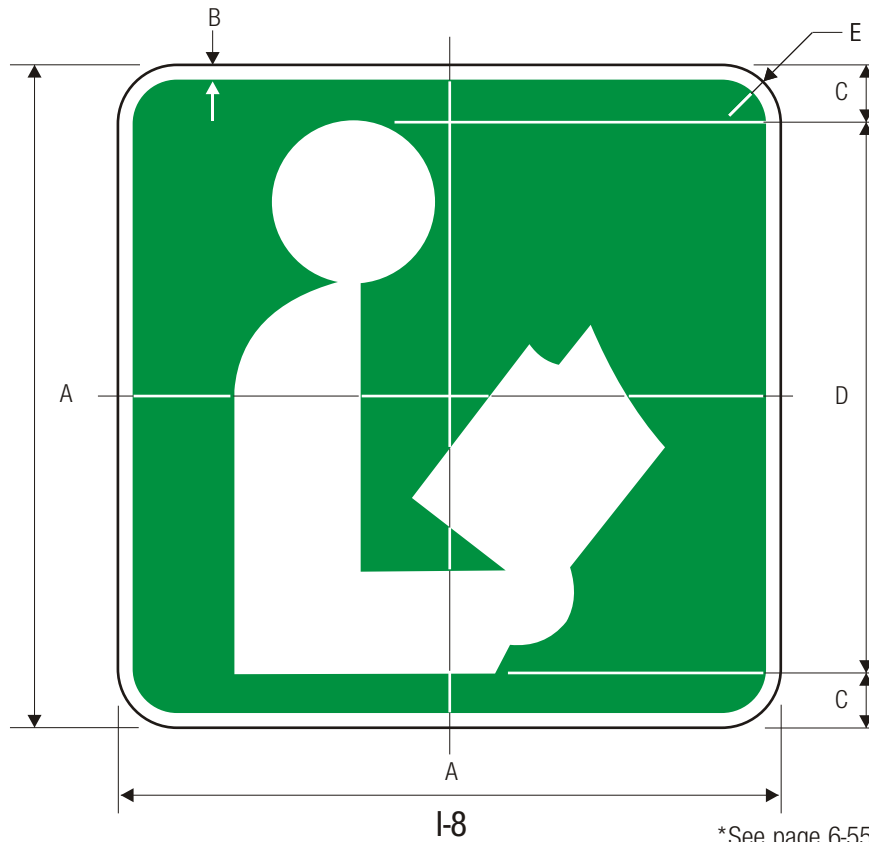

*See page 6-55 for symbol design.

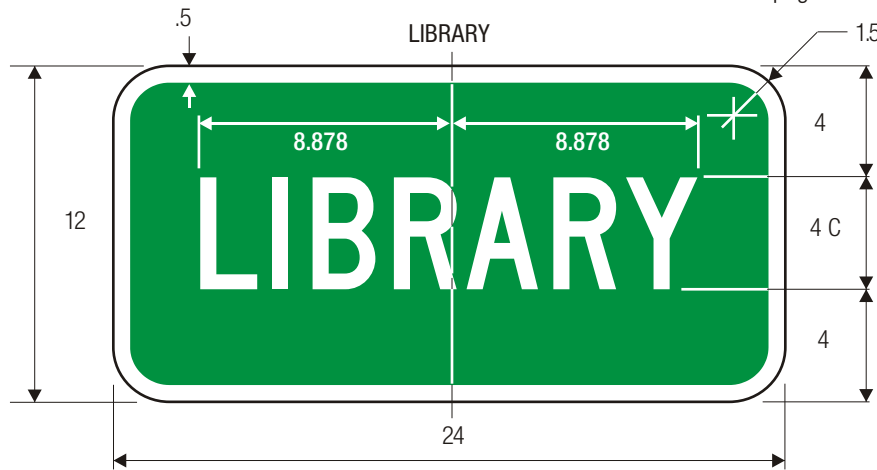

LIBRARY

Smaller size panels may be used as applicable within terminal areas.

A	B	C	D	E
18	.5	1.5	15	1.5
24	.5	2	20	1.5
30	.75	2.5	25	1.875

COLORS: SYMBOL WHITE (RETROREFLECTIVE)
 LEGEND WHITE (RETROREFLECTIVE)
 BACKGROUND GREEN (RETROREFLECTIVE)



I-11

RECYCLING

*See page 6-14 for symbol design.

COLORS: LEGEND WHITE (RETROREFLECTIVE)
 BACKGROUND GREEN (RETROREFLECTIVE)

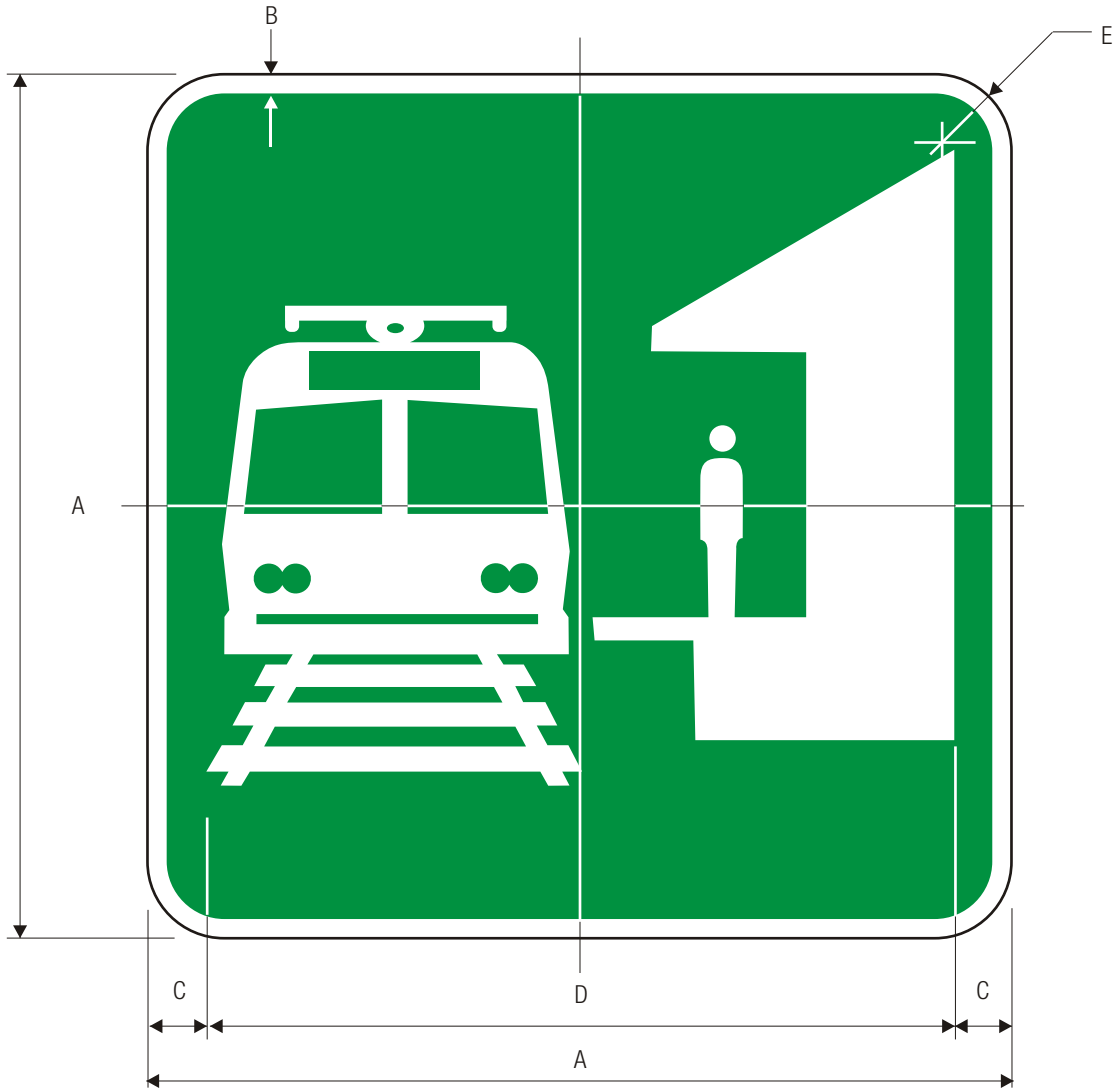

I-12

LIGHT RAIL STATION

*See page 6-18 for symbol design.

A	B	C	D	E
18	.5	1.25	15.5	1.5
24	.5	1.625	20.75	1.5
30	.75	2	26	1.875

COLORS: SYMBOL WHITE (RETROREFLECTIVE)
 BACKGROUND GREEN (RETROREFLECTIVE)

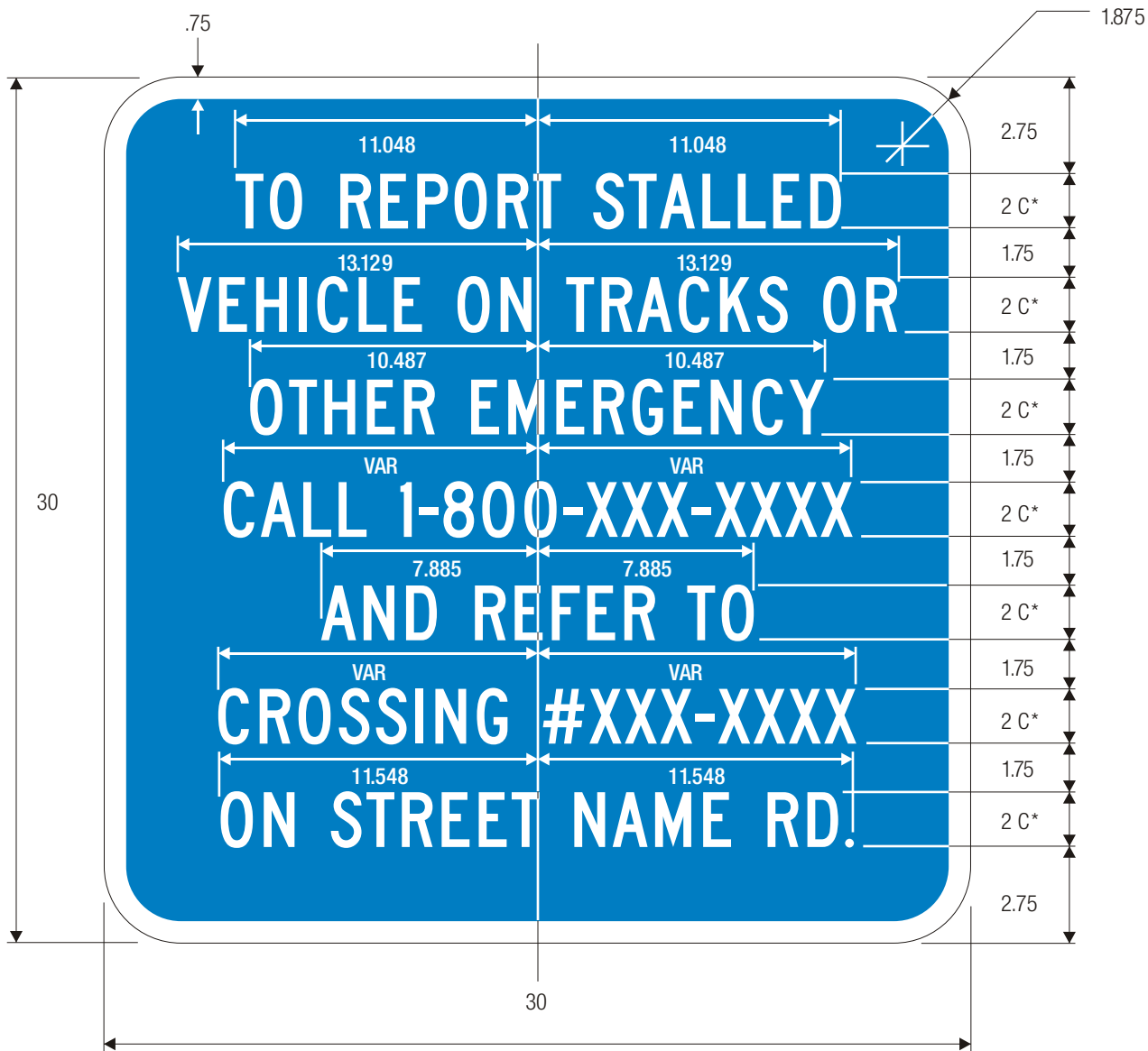

I-13

EMERGENCY NOTIFICATION

*Series 2000 Standard Alphabets.

COLORS: LEGEND WHITE (RETROREFLECTIVE)
 BACKGROUND BLUE (RETROREFLECTIVE)

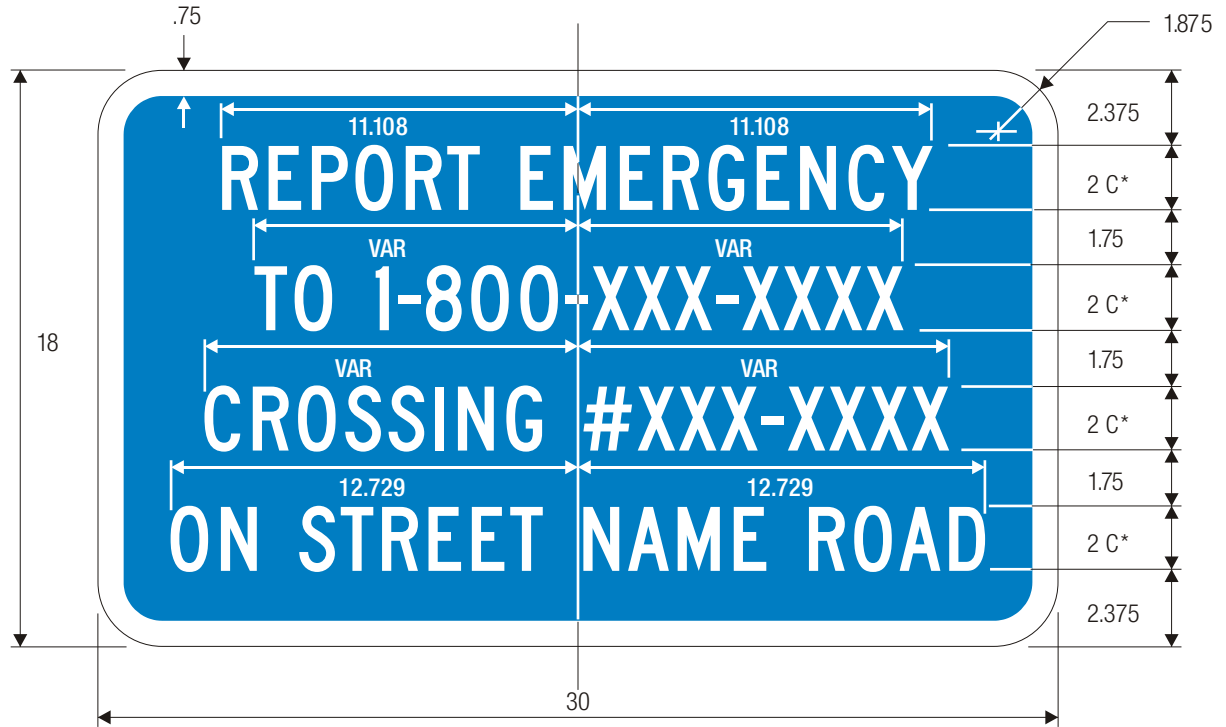

I-13a

EMERGENCY NOTIFICATION

*Series 2000 Standard Alphabets.

COLORS: LEGEND WHITE (RETROREFLECTIVE)
 BACKGROUND BLUE (RETROREFLECTIVE)

MOTORIST SERVICES SYMBOL SIGN

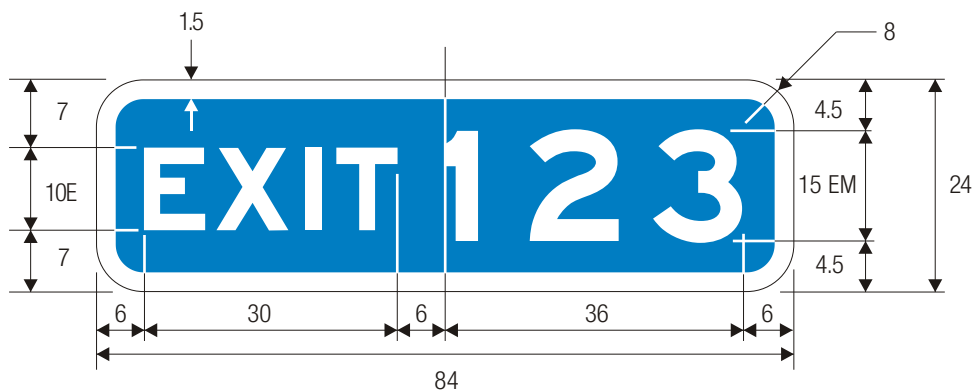

E1-5

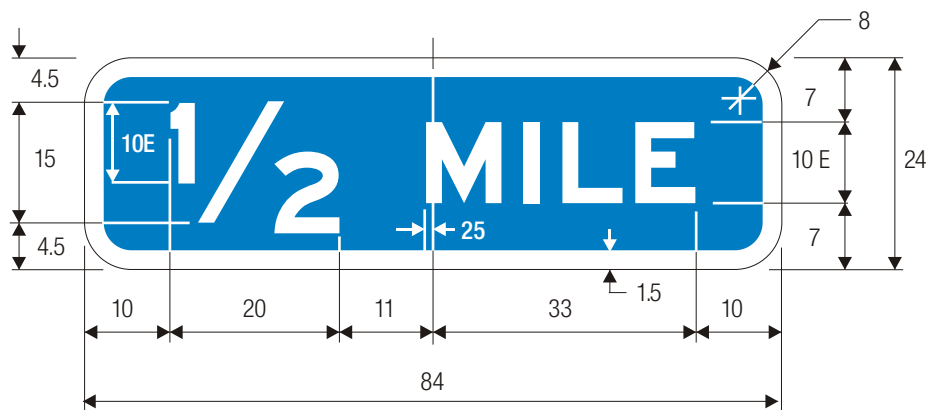

E2-3
ENGLISH

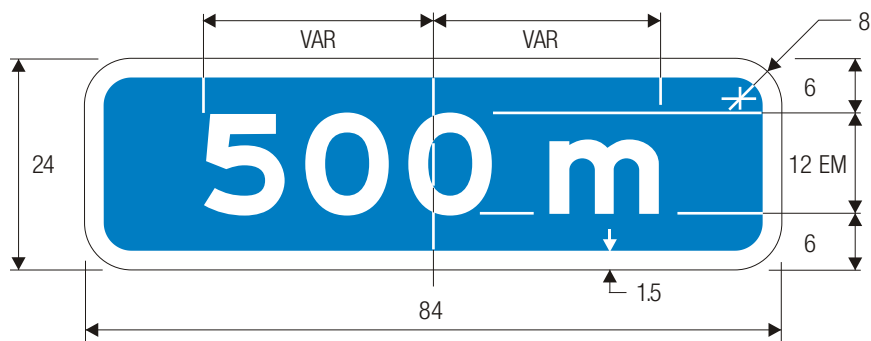

E2-3
METRIC

COLORS: LEGEND – WHITE (RETROREFLECTIVE)
 BACKGROUND – BLUE (RETROREFLECTIVE)

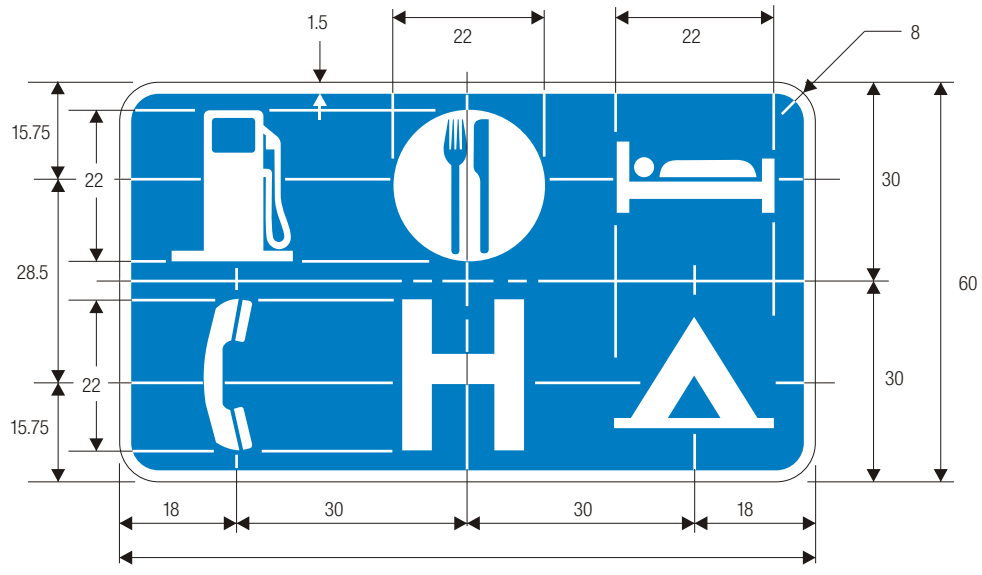

See Appendix 6 for General Service Symbols

D9-18

MOTORIST SERVICES SIGNS

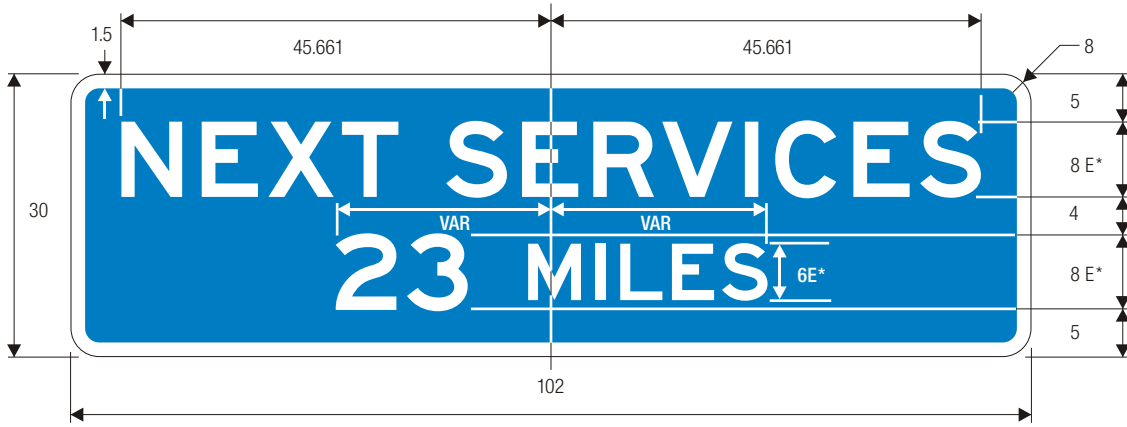

D9-17

*Series 2000 Standard Alphabets.

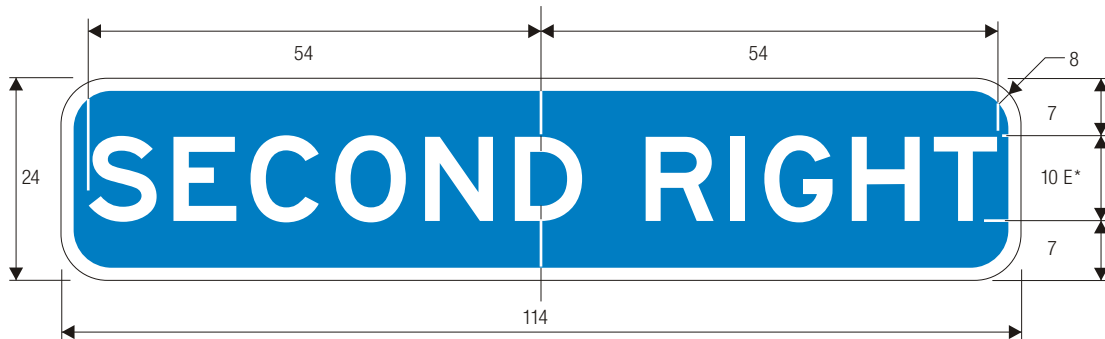

E2-2

COLORS: LEGEND — WHITE (RETROREFLECTIVE)
BACKGROUND — BLUE (RETROREFLECTIVE)

MOTORIST SERVICES SIGNS

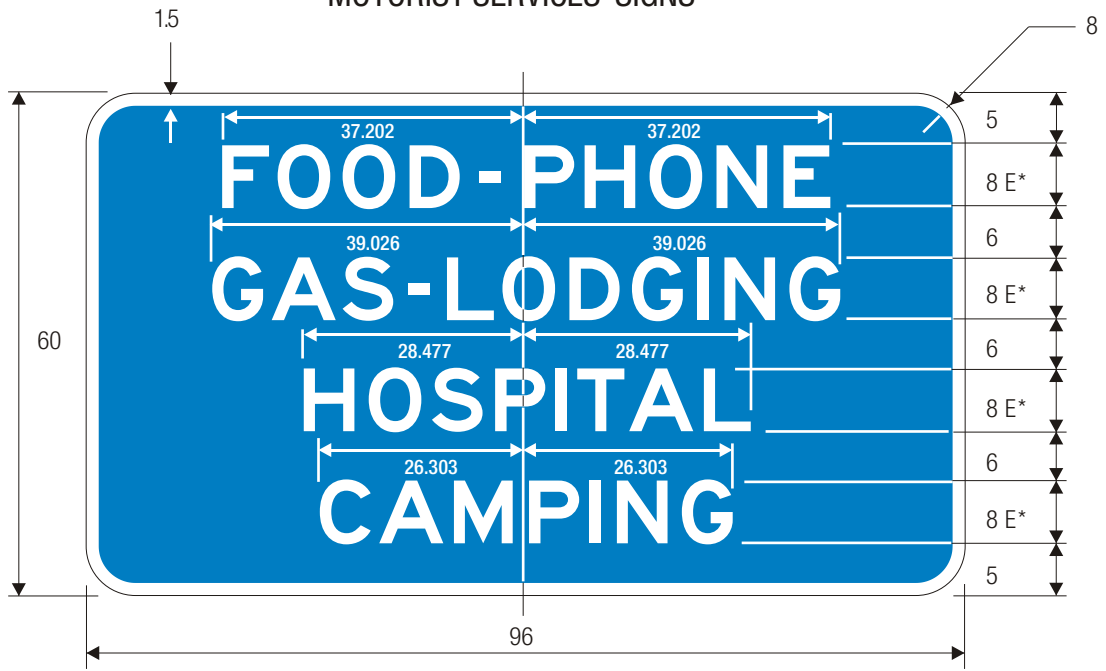

D9-18a

*Series 2000 Standard Alphabets.

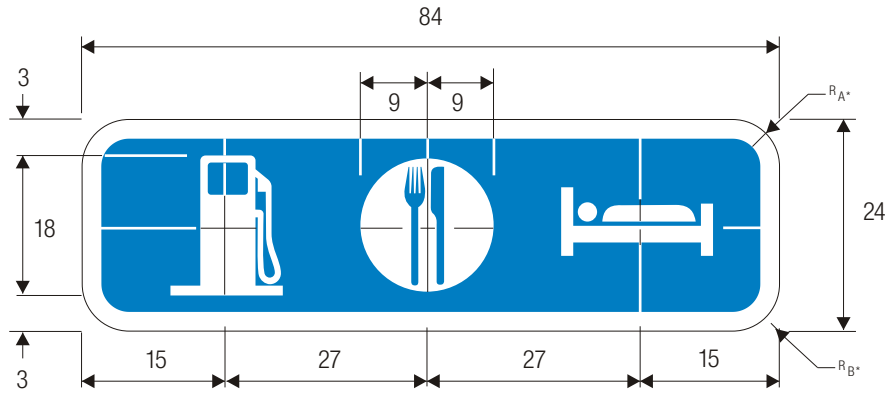

See Appendix 6 for Motorist Service Symbols.

D9-18b

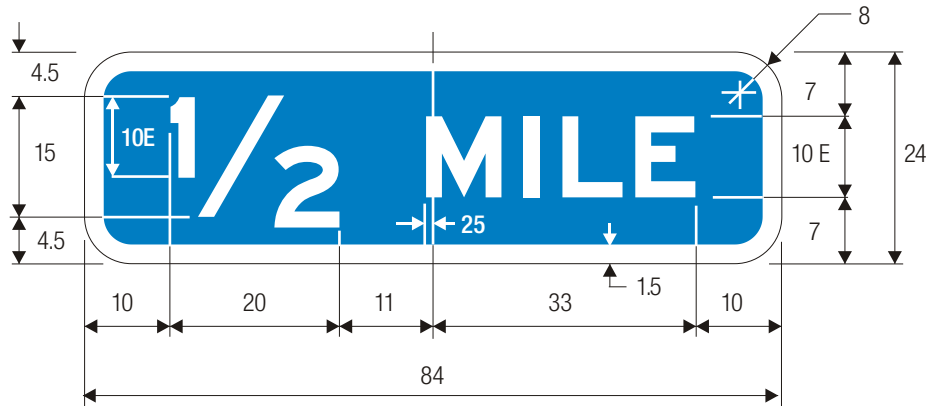

E2-3
ENGLISH

COLORS: LEGEND — WHITE (RETROREFLECTIVE)
BACKGROUND— BLUE (RETROREFLECTIVE)

MOTORIST SERVICES SIGNS

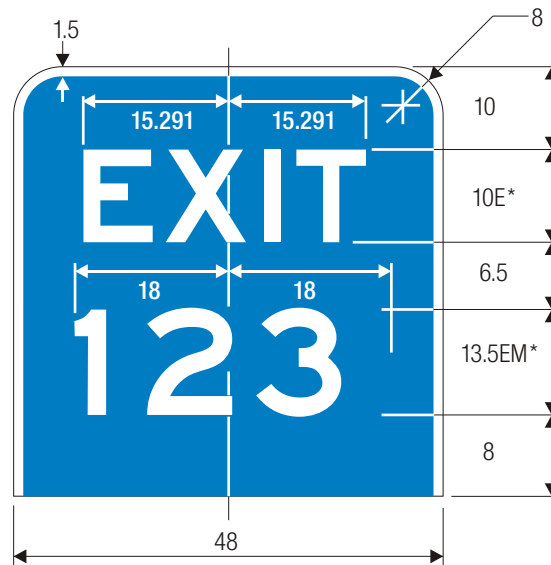

E1-5a

*Series 2000 Standard Alphabets.

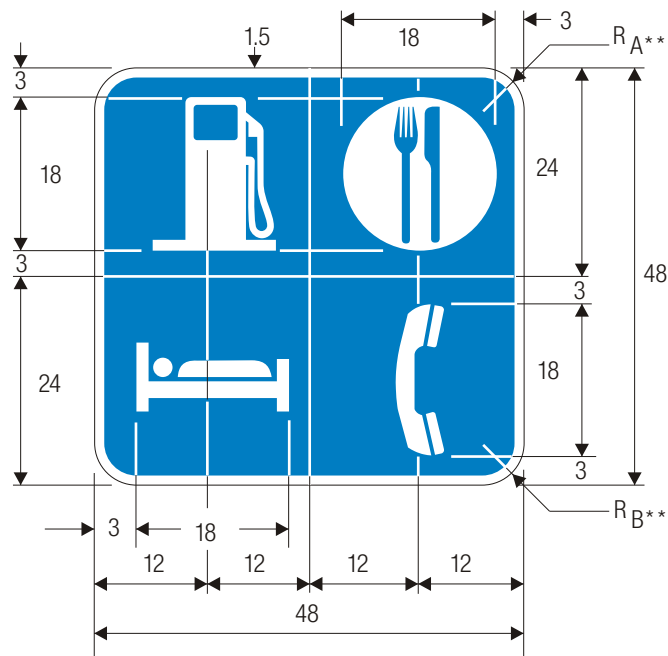

D9-18c

COLORS: LEGEND — WHITE (RETROREFLECTIVE)
 BACKGROUND — BLUE (RETROREFLECTIVE)

MOTORIST SERVICES SYMBOL SIGN



D9-18c

*Series 2000 Standard Alphabets.

COLORS: LEGEND — WHITE (RETROREFLECTIVE)
 BACKGROUND — BLUE (RETROREFLECTIVE)

Recreation and Cultural Interest Area Signs



RG-010
AUTOMOBILE

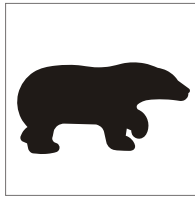

RG-020
BEAR VIEWING AREA

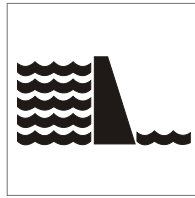

RG-030
DAM

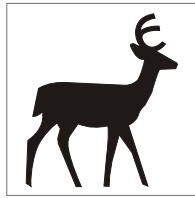

RG-040
DEER VIEWING AREA



RG-050
DRINKING WATER



RG-060
ENVIRONMENTAL STUDY



RG-070
FALLING ROCK

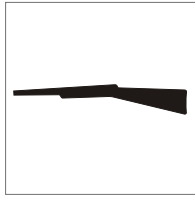

RG-080
FIREARMS

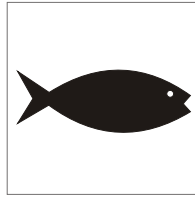

RG-090
FISH HATCHERY



RG-100
INFORMATION



RG-110
LEASHED PETS



RG-120
LIGHTHOUSE



RG-130
LITTER CONTAINER

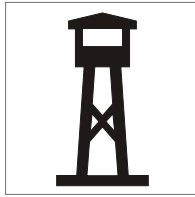

RG-140
LOOKOUT TOWER



RG-150
PEDESTRIAN CROSSING

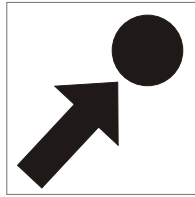

RG-160
POINT OF INTEREST



RG-170
RANGER STATION



RG-180
SMOKING



RG-190
TRUCK



RG-200
TUNNEL

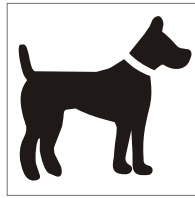

RG-240
DOG

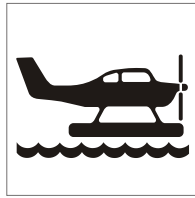

RG-260
SEAPLANE

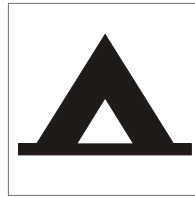

RM-010
CAMPING (TENT)



RM-020
CAMPING (TRAILER)



RM-030
FERRY

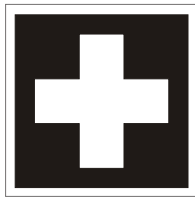

RM-040
FIRST AID

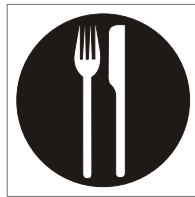

RM-050
FOOD



RM-060
GAS



RM-070
GROCERY STORE



RM-080
HANDICAPPED



RM-090
LODGING

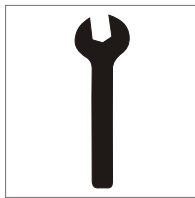

RM-100
MECHANIC

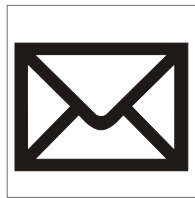

RM-110
POST OFFICE

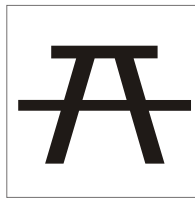

RM-120
PICNIC AREA



RM-130
PICNIC SHELTER



RM-140
REST ROOM

Recreation and Cultural Interest Area Signs



RM-150
TELEPHONE

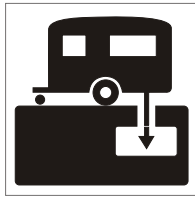

RM-160
SANITARY STATION

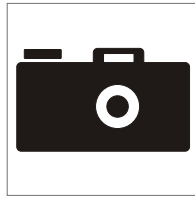

RM-170
VIEWING AREA



RM-200
MOTOR HOME

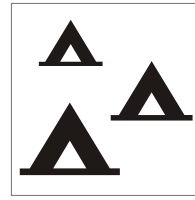

RM-210
GROUP CAMPING

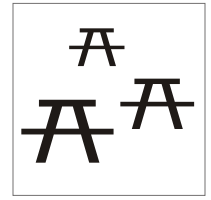

RM-220
GROUP PICNICKING



RA-010
AIRPORT



RA-020
BUS STOP



RA-030
CAMPFIRE



RA-040
ELEVATOR



RA-050
KENNEL

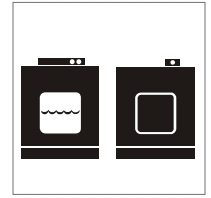

RA-060
LAUNDRY



RA-070
LOCKER

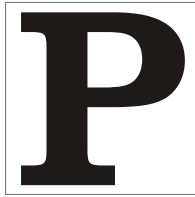

RA-080
PARKING



RA-090
REST ROOM (MEN)



RA-100
REST ROOM (WOMEN)



RA-110
SHELTER (SLEEPING)

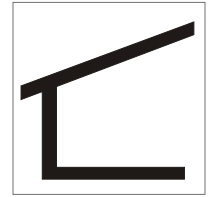

RA-120
SHELTER (TRAIL)



RA-130
SHOWERS



RA-150
FAMILY REST ROOM

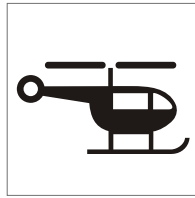

RA-160
HELICOPTER

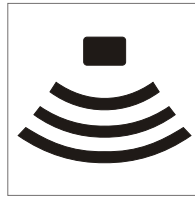

RL-010
AMPHITHEATER



RL-020
CLIMBING



RL-030
CLIMBING (ROCK)



RL-040
HUNTING

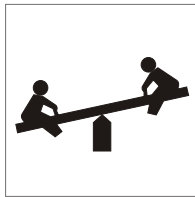

RL-050
PLAYGROUND



RL-060
ROCK COLLECTING



RL-070
SPELUNKING

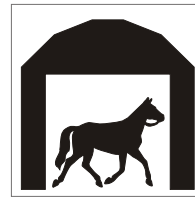

RL-080
STABLE



RL-090
TRAIL (BICYCLE)



RL-100
TRAIL (HIKING)

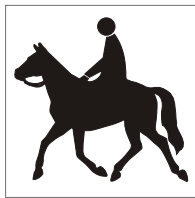

RL-110
TRAIL (HORSE)

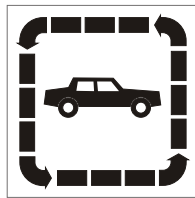

RL-120
TRAIL (AUTO)

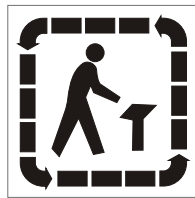

RL-130
TRAIL (PEDESTRIAN)

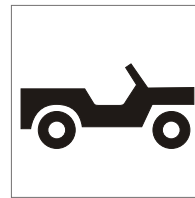

RL-140
TRAIL (4WD)



RL-150
TRAIL (BIKE)

Recreation and Cultural Interest Area Signs



RL-160
TRAMWAY



RL-170
ATV



RL-190
ARCHER



RL-210
HANG GLIDER

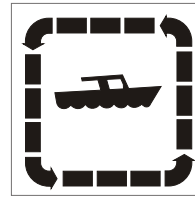

RW-010
BOAT TOURS



RW-020
CANOEING



RW-030
DIVING

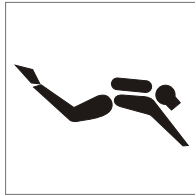

RW-040
DIVING (SCUBA)

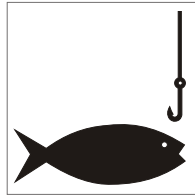

RW-050
FISHING

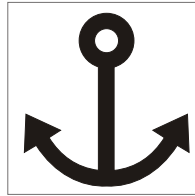

RW-060
MARINA

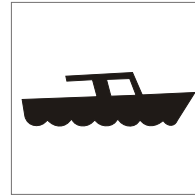

RW-070
MOTORBOATING

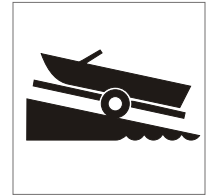

RW-080
RAMP (LAUNCH)



RW-090
ROWBOATING

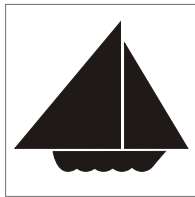

RW-100
SAILBOATING



RW-110
SKIING (WATER)



RW-120
SURFING



RW-130
SWIMMING



RW-140
WADING



RW-160
FISHING PIER



RW-170
HAND LAUNCH



RW-190
KAYAK



RW-210
WIND SURF



RS-010
SKATING (ICE)



RS-020
SKI JUMPING



RS-030
SKIING (BOBBING)



RS-040
SKI (CROSS COUNTRY)



RS-050
SKI (DOWNHILL)



RS-060
SLEDDING



RS-070
SNOWMOBILING



RS-080
SNOWSHOEING



RS-090
WINTER REC AREA



RS-100
SKI LIFT

EXAMPLES OF DESIGN APPLICATIONS
RECREATIONAL & CULTURAL INTEREST SIGNS

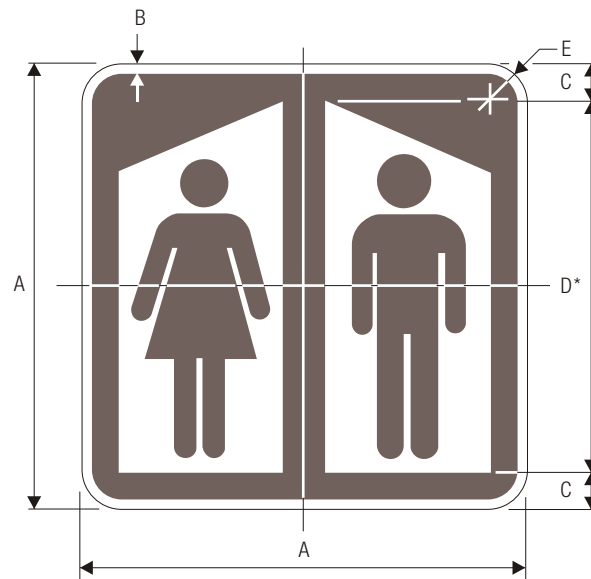

RM-140

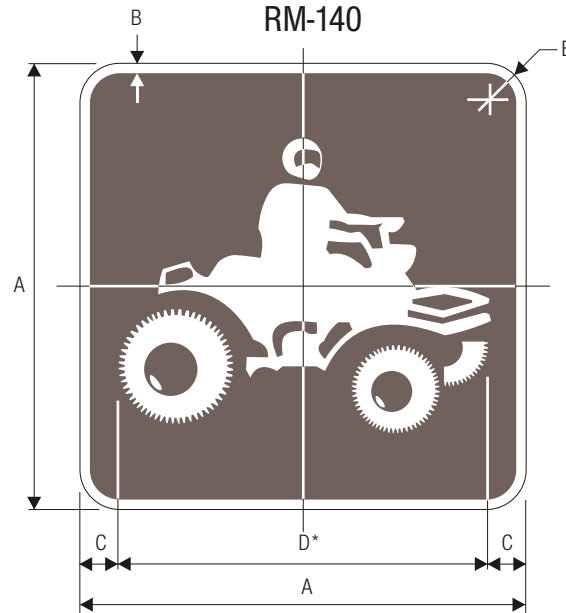

RL-170

* The largest dimension of most symbols should be about 83.5% of the total sign width.
Symbols for showers, trailer sanitary stations, boat tours, interpretative trails, and climbing areas should extend near or into the sign border as shown in the grid layouts.

A	B	C	D	E	F
24	.5	2	20	1.5	3
18	.5	1.5	15	1.5	2.25
12	.375	1	10	.75	1.5
9	.375	.75	7.5	.75	1.125
6	.25	.5	5	.375	.75

COLORS: LEGEND — WHITE (REFLECTIVE)
BACKGROUND — BROWN

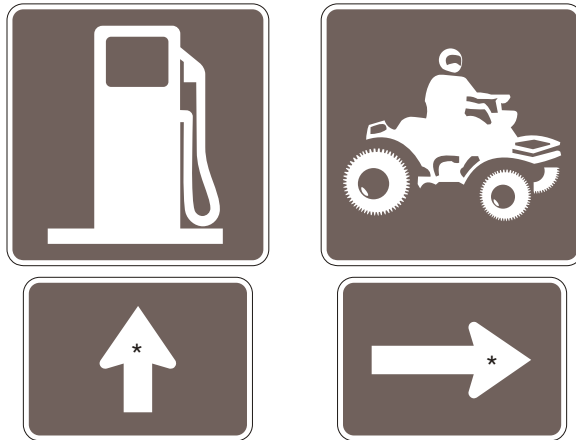

Recreational and Cultural Sign Array



*See page 6-2 for Arrow design

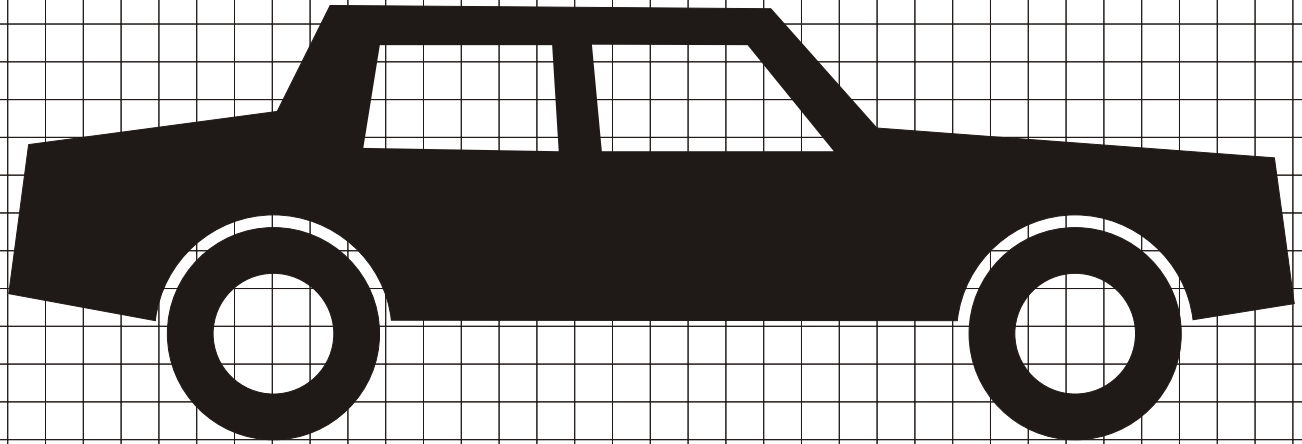

RG-010

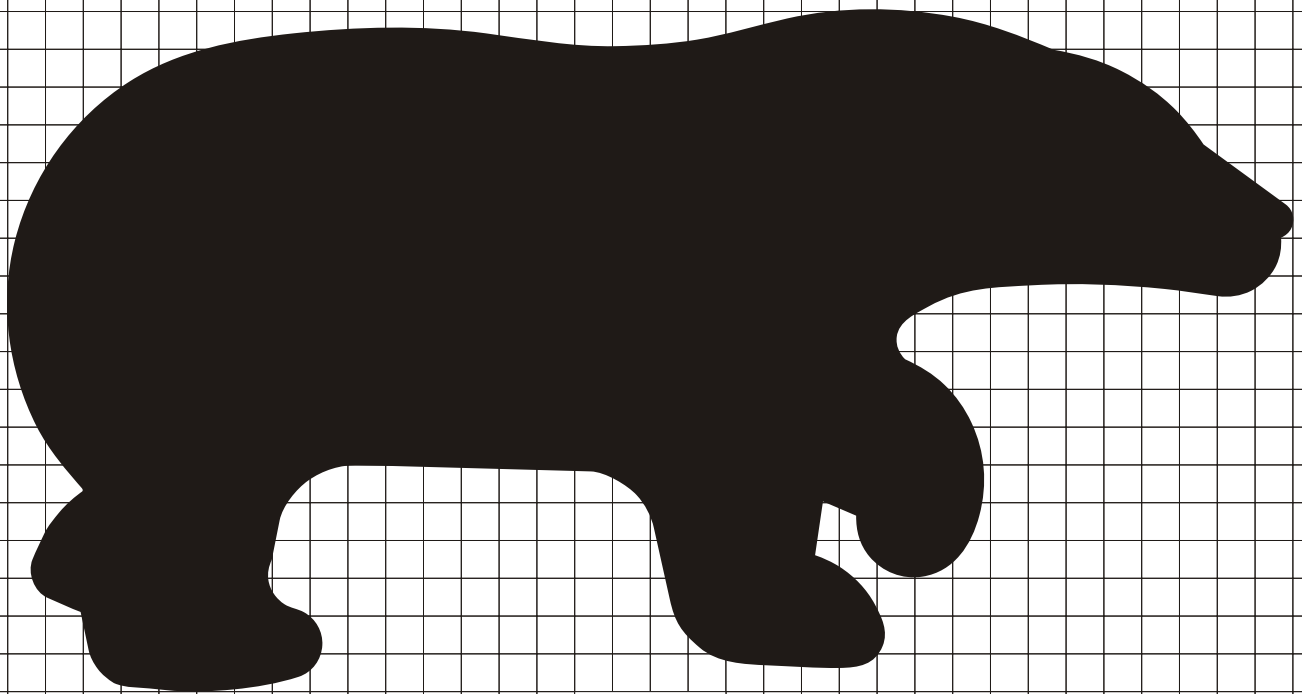

RG-020

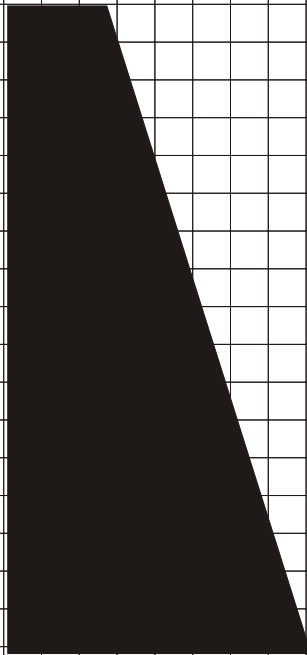
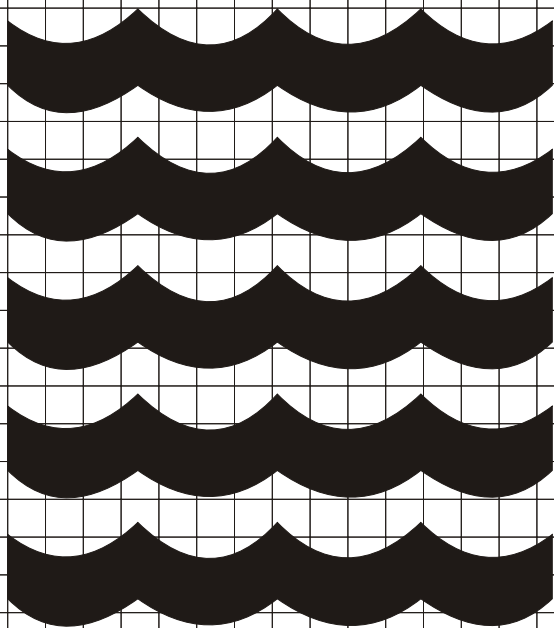

RG-030

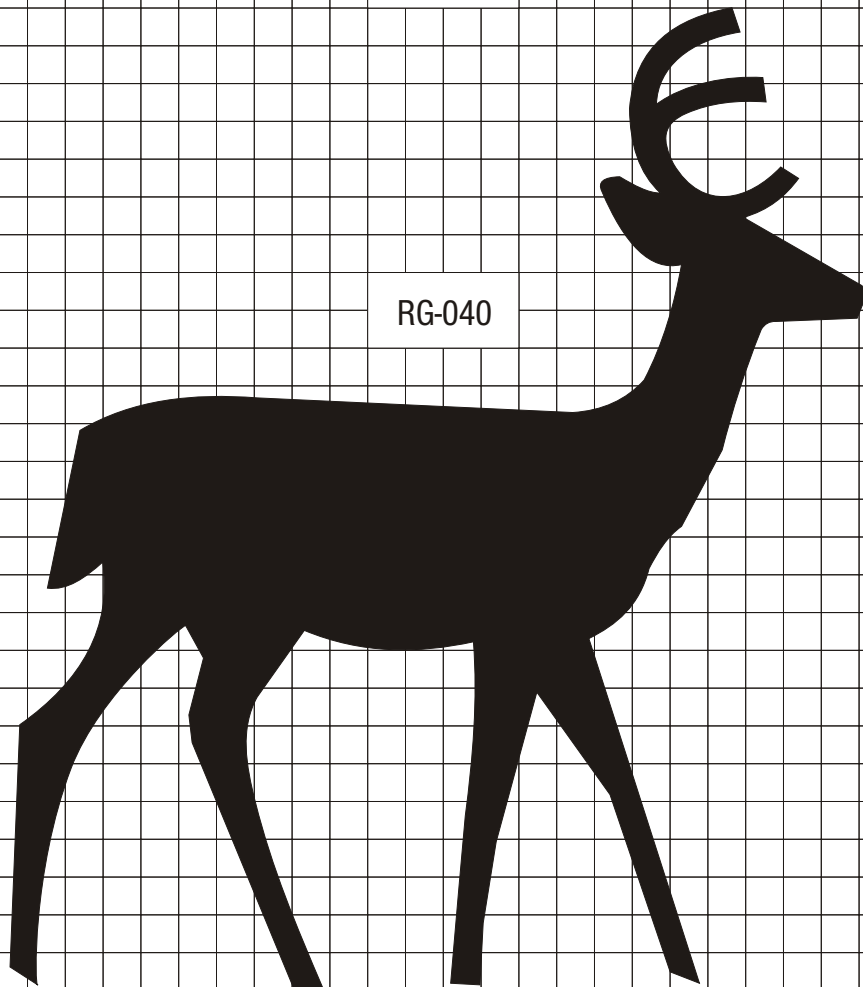

RG-040

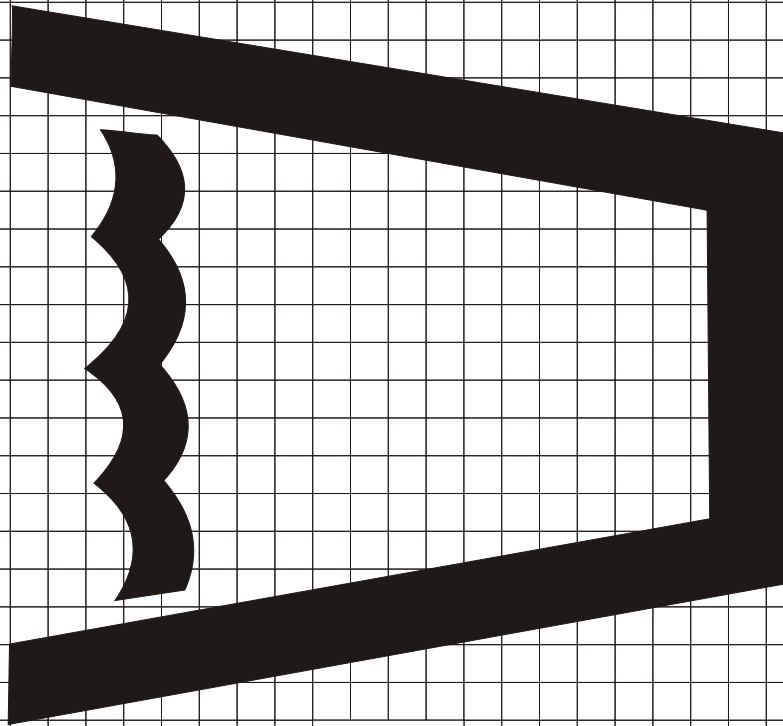

RG-050

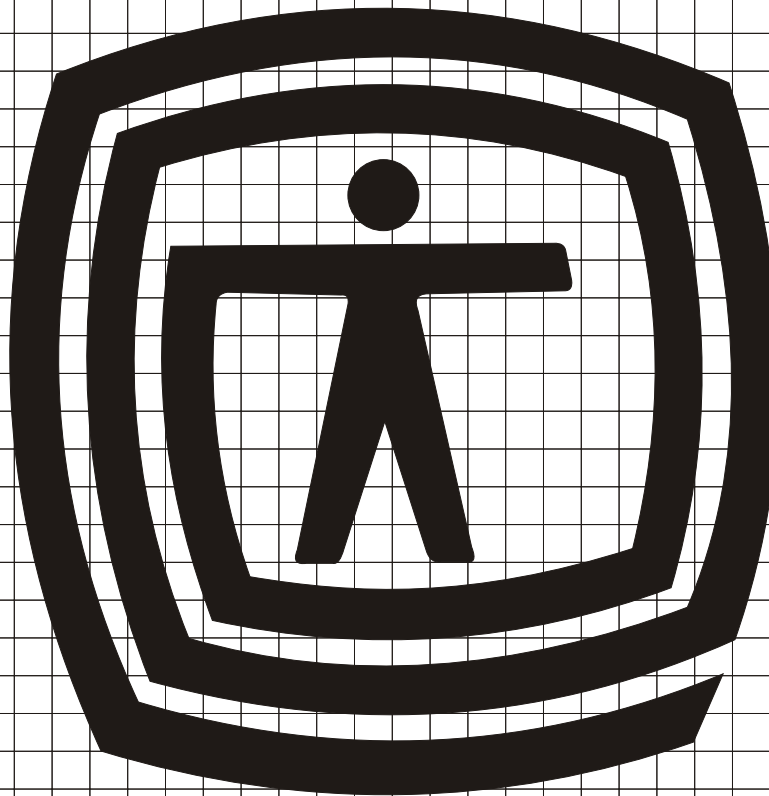

RG-060

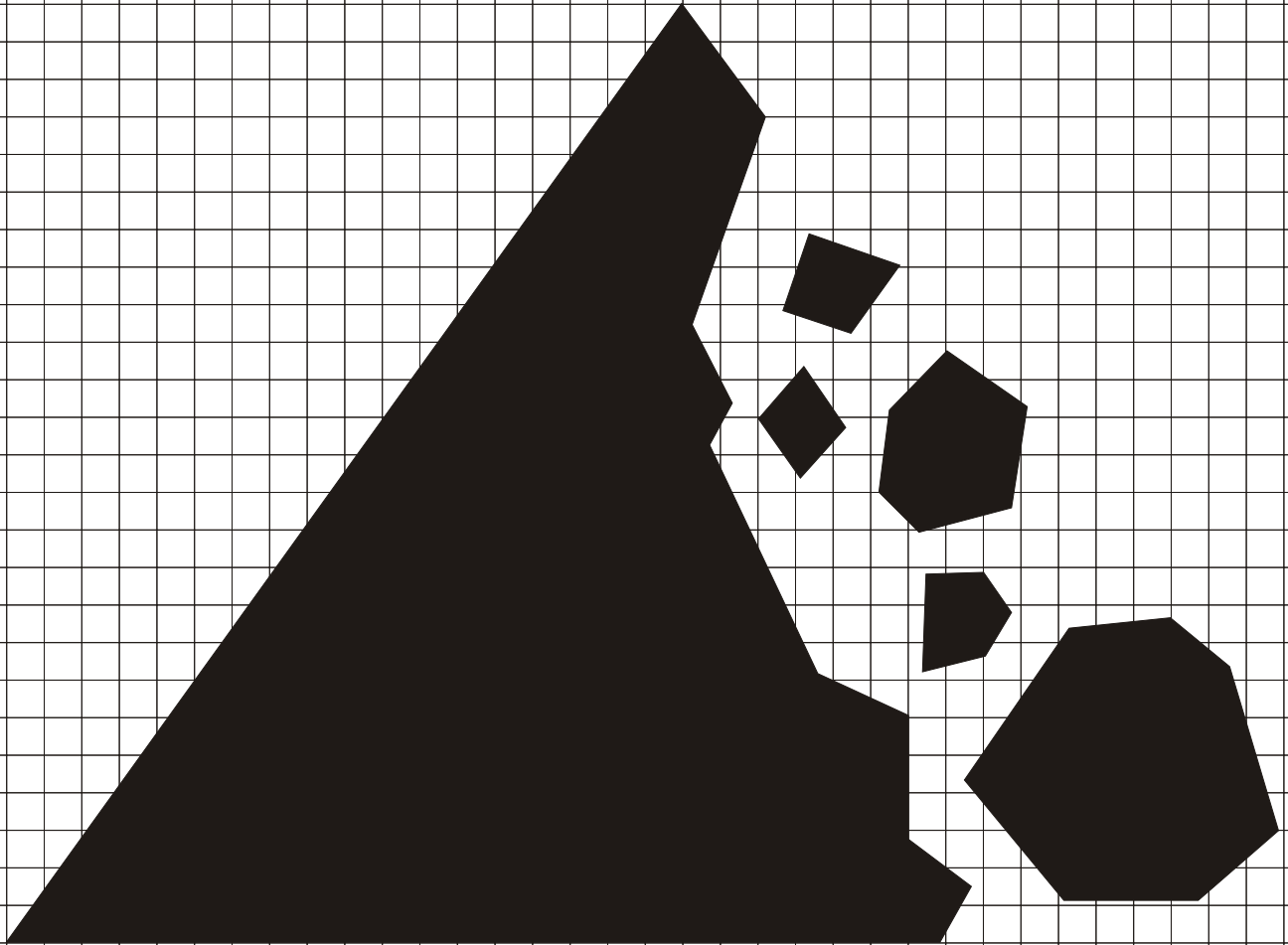

RG-070

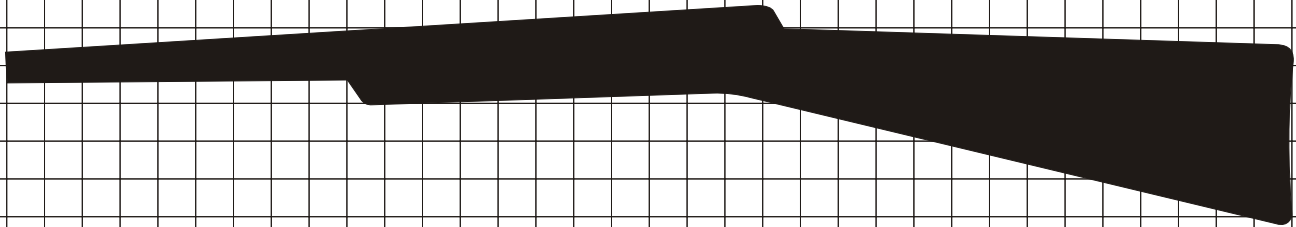

RG-080

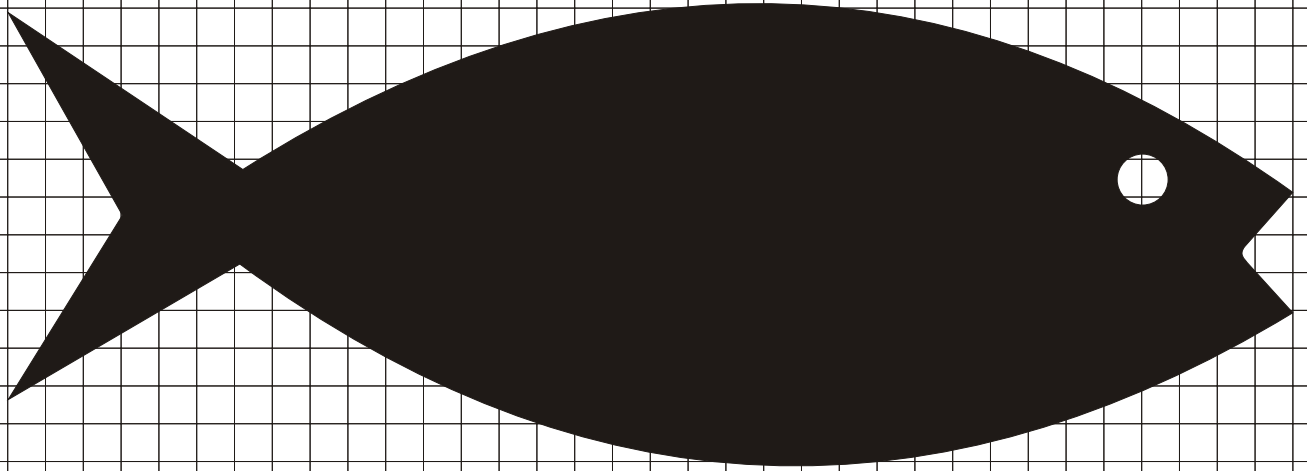

RG-090

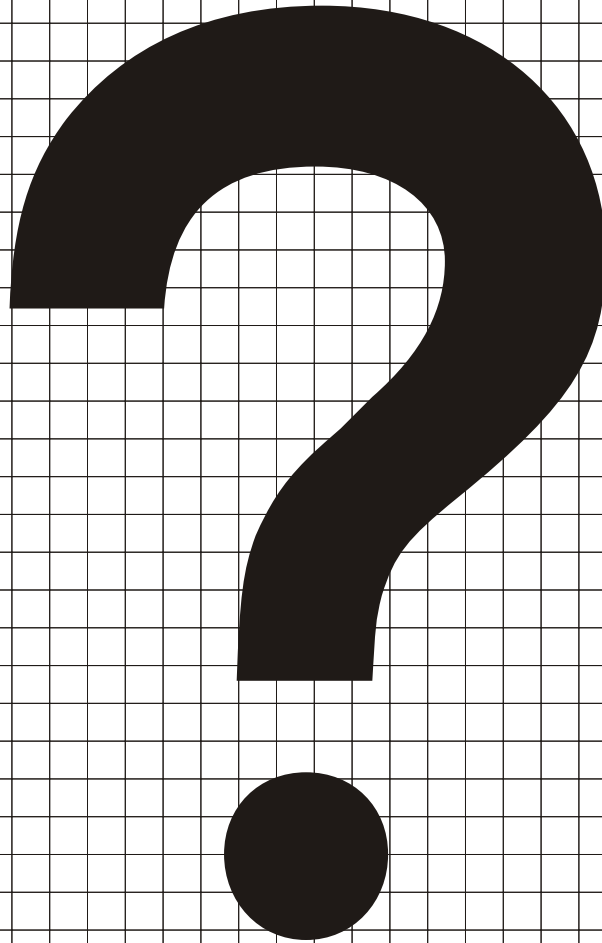

RG-100

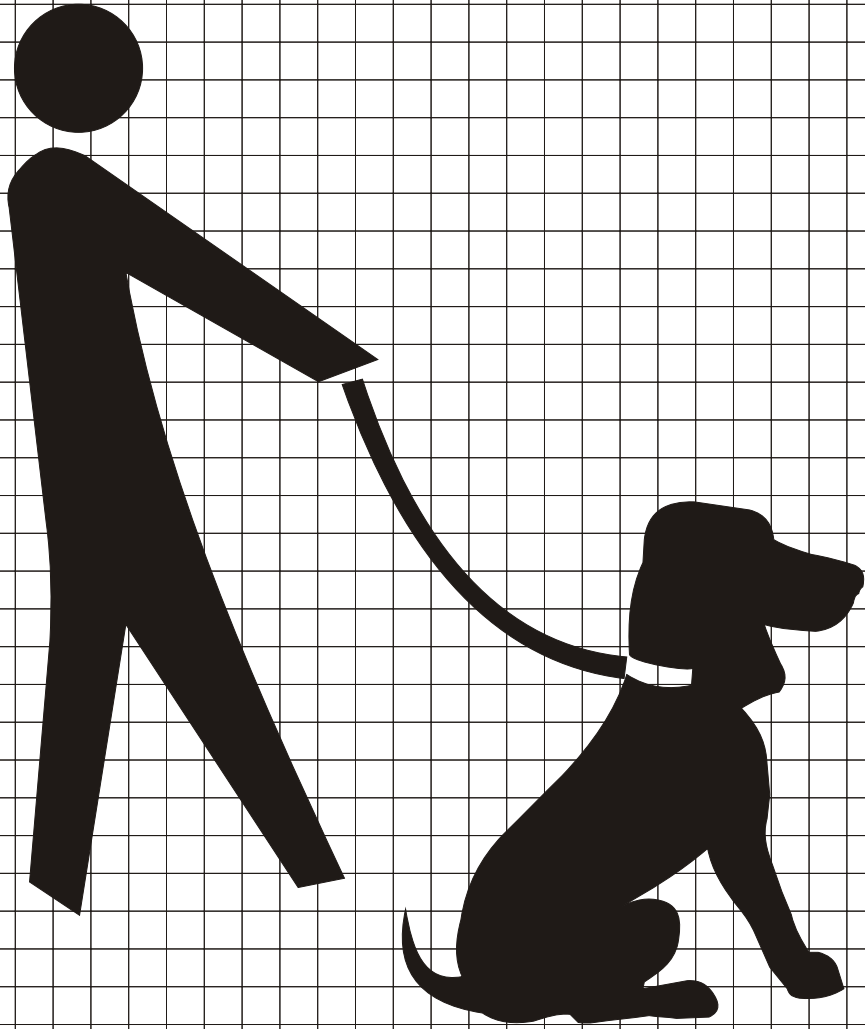

RG-110

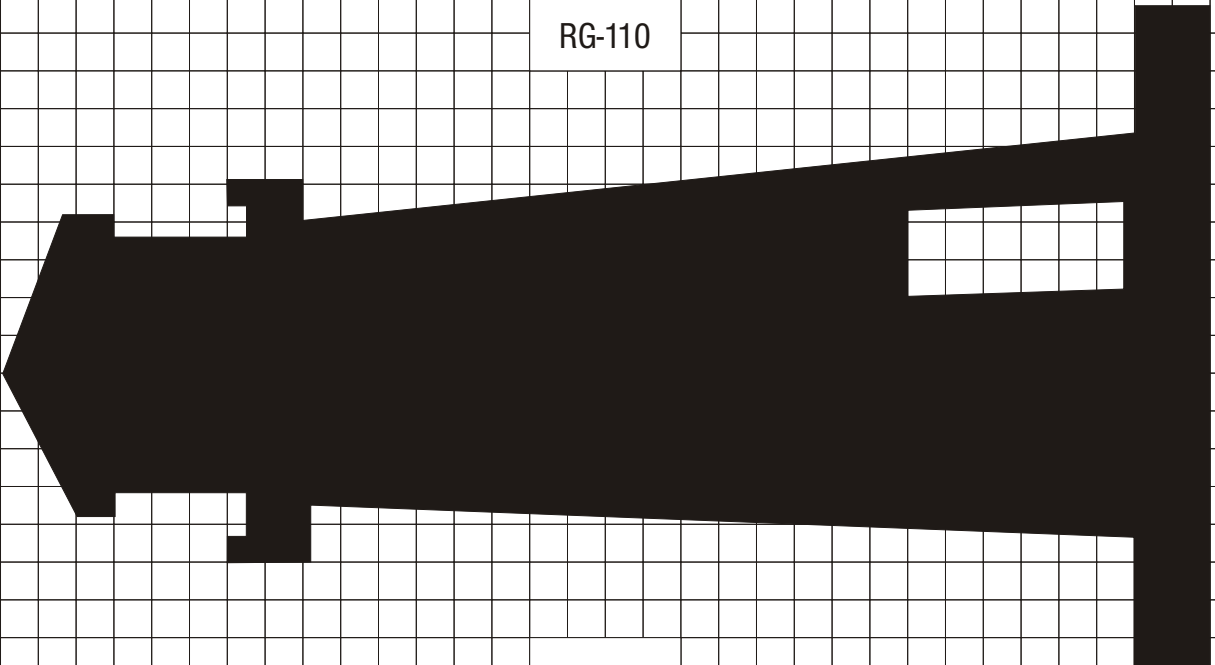

RG-120

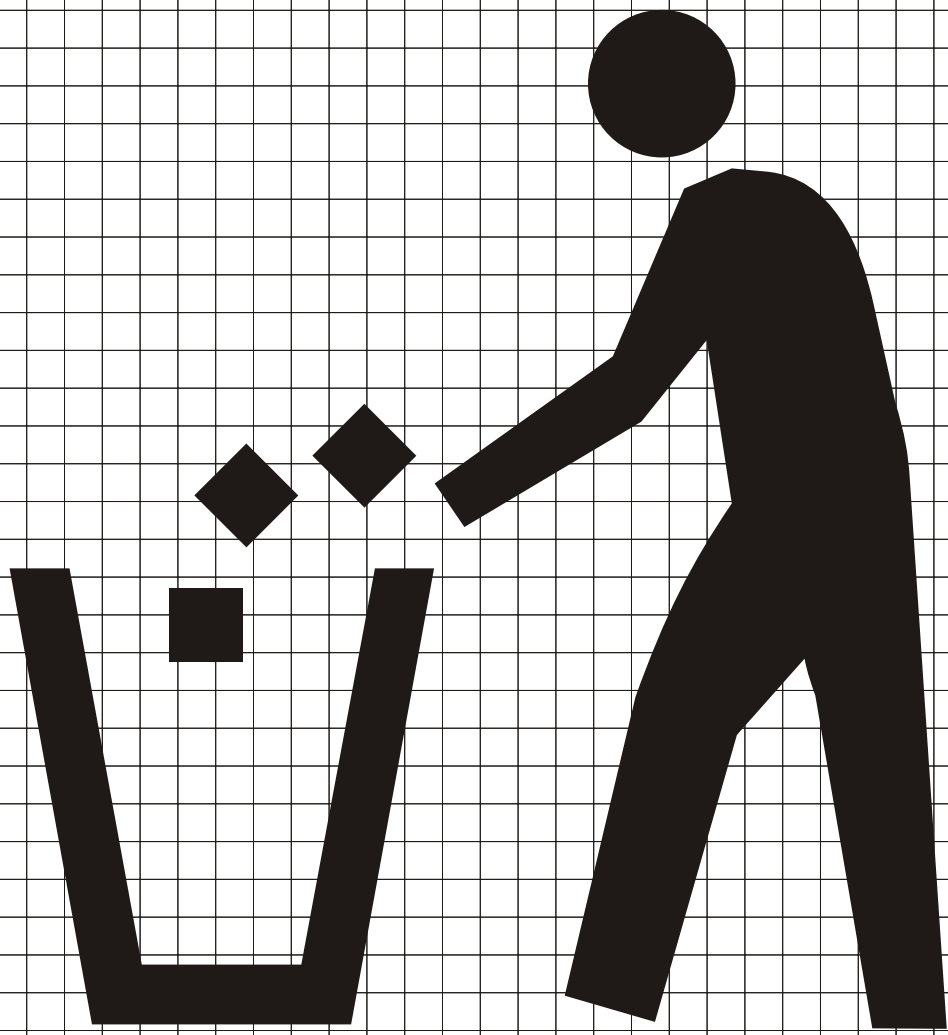

RG-130

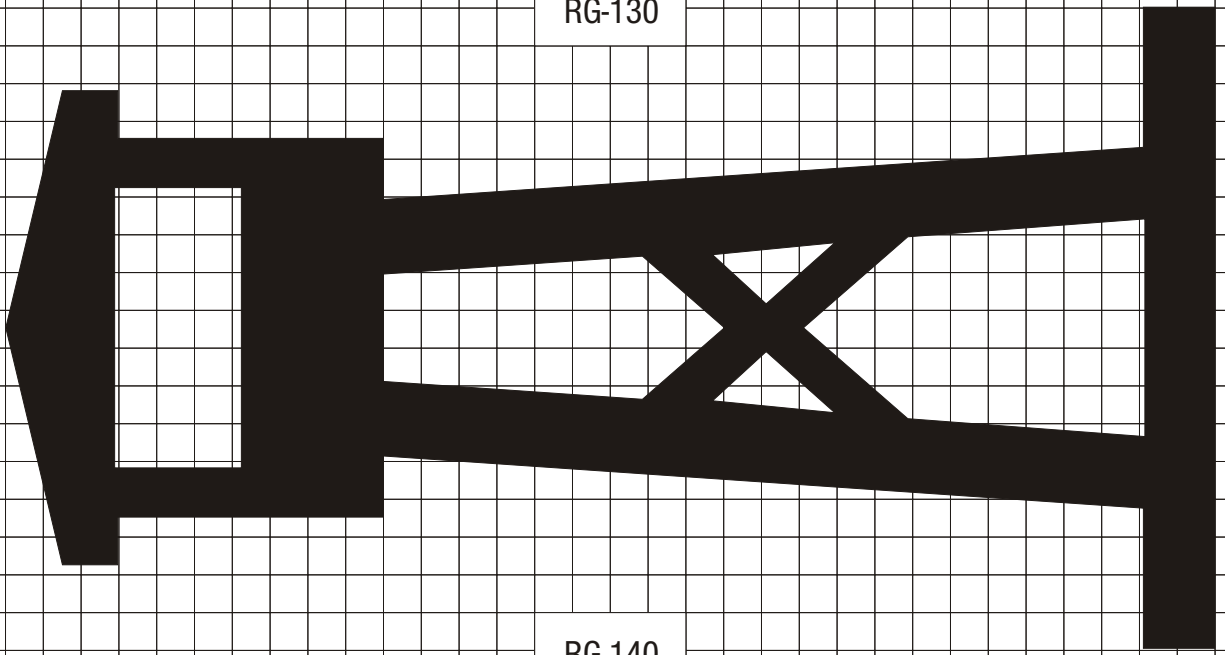

RG-140

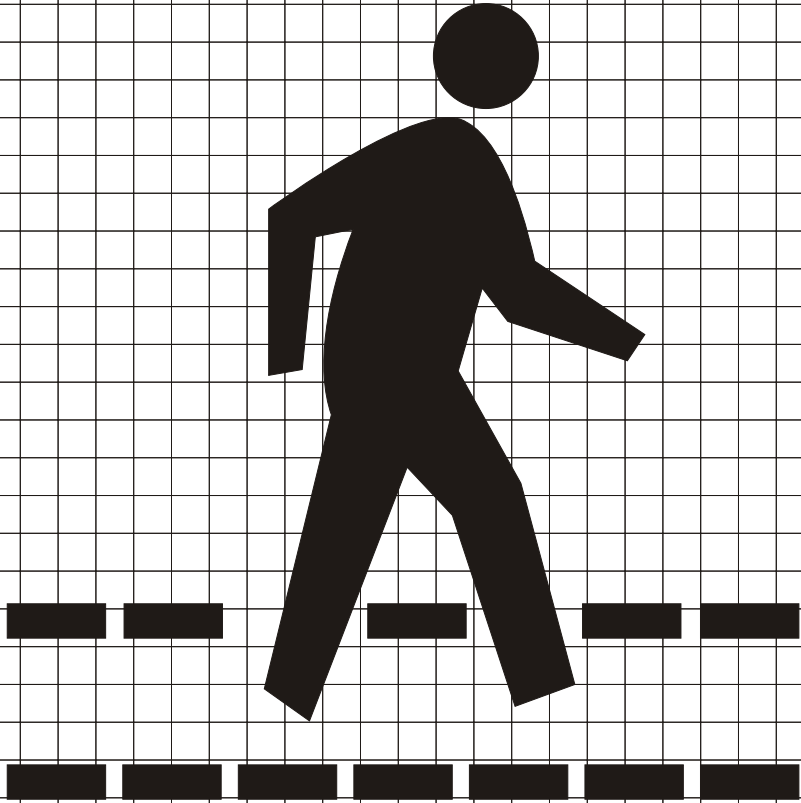

RG-150

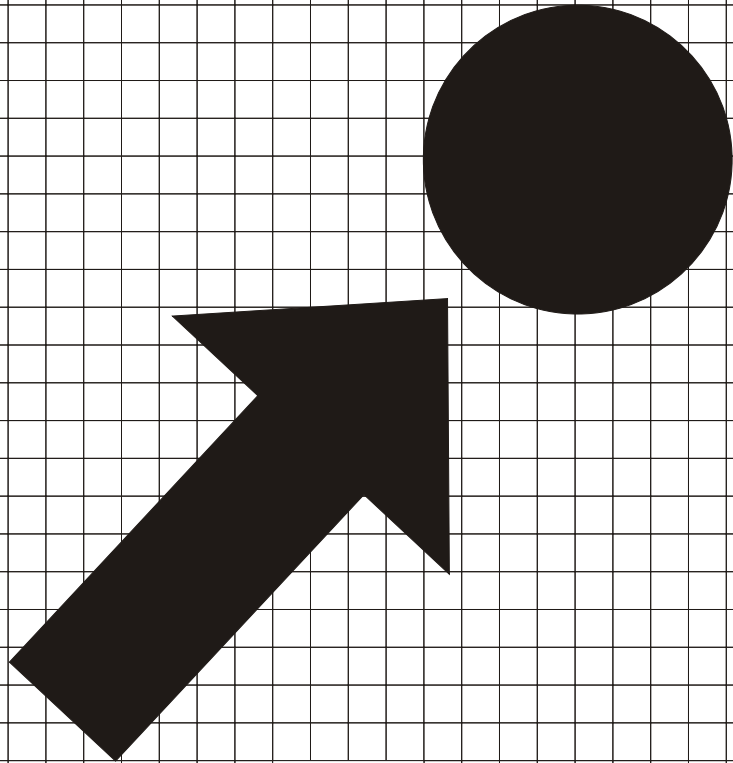

RG-160

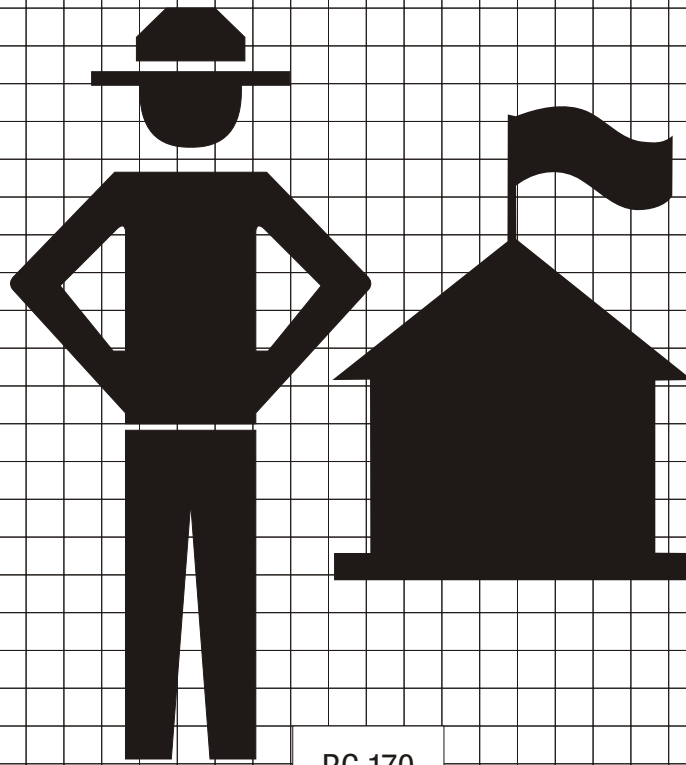

RG-170

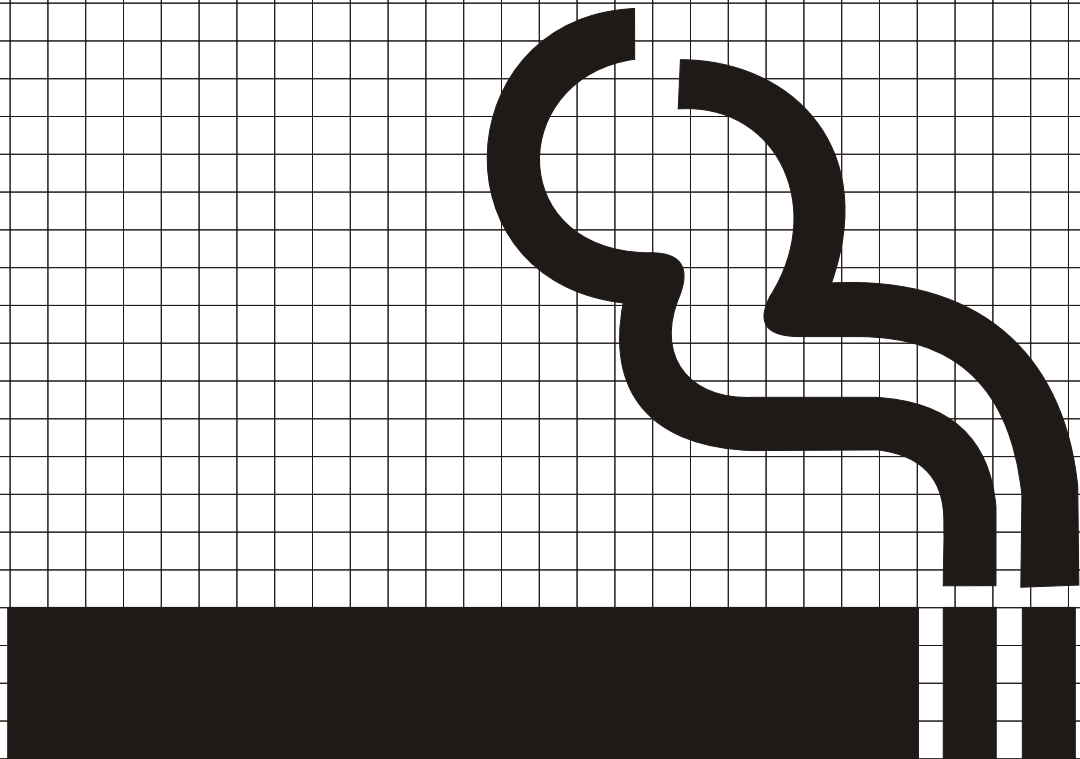

RG-180



RG-190

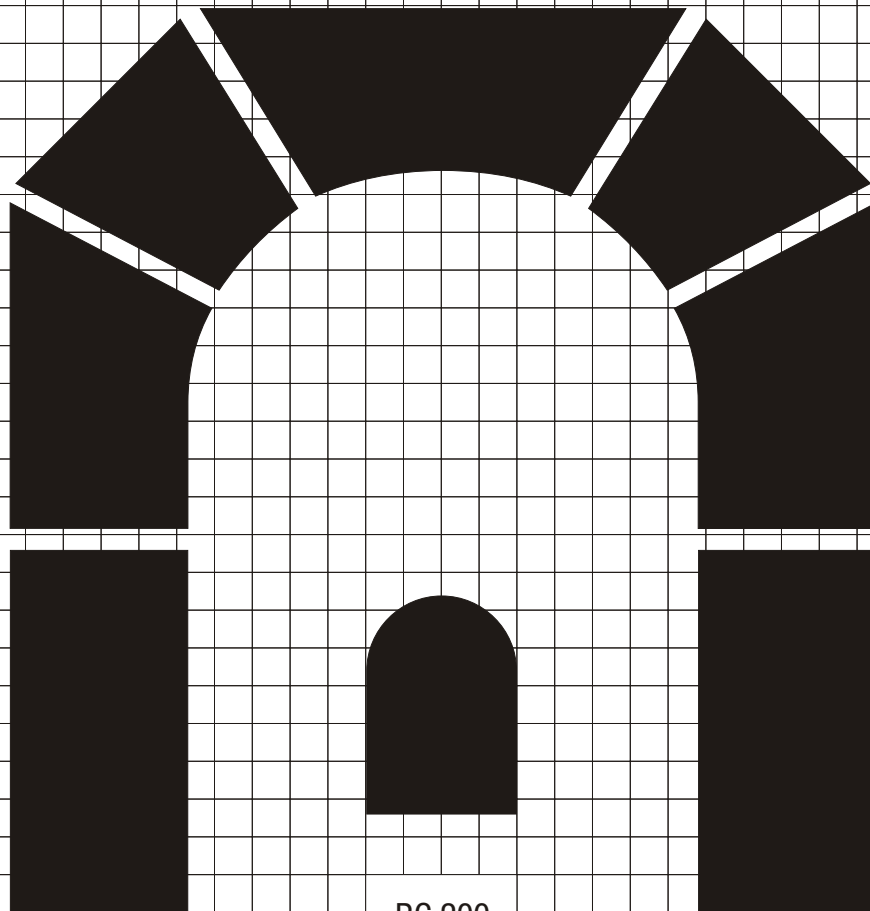

RG-200

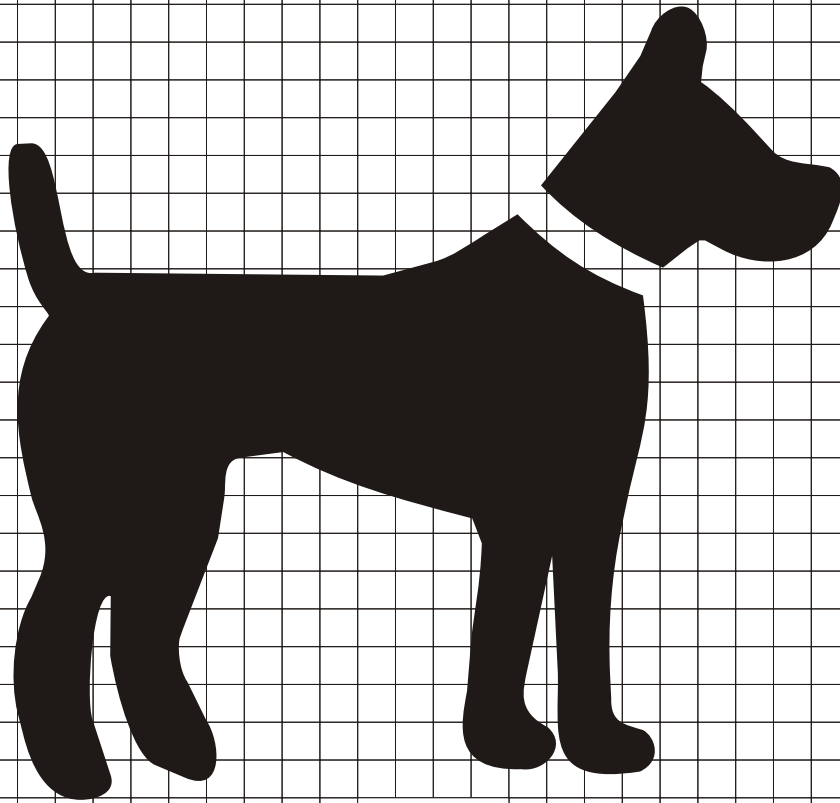

RG-240

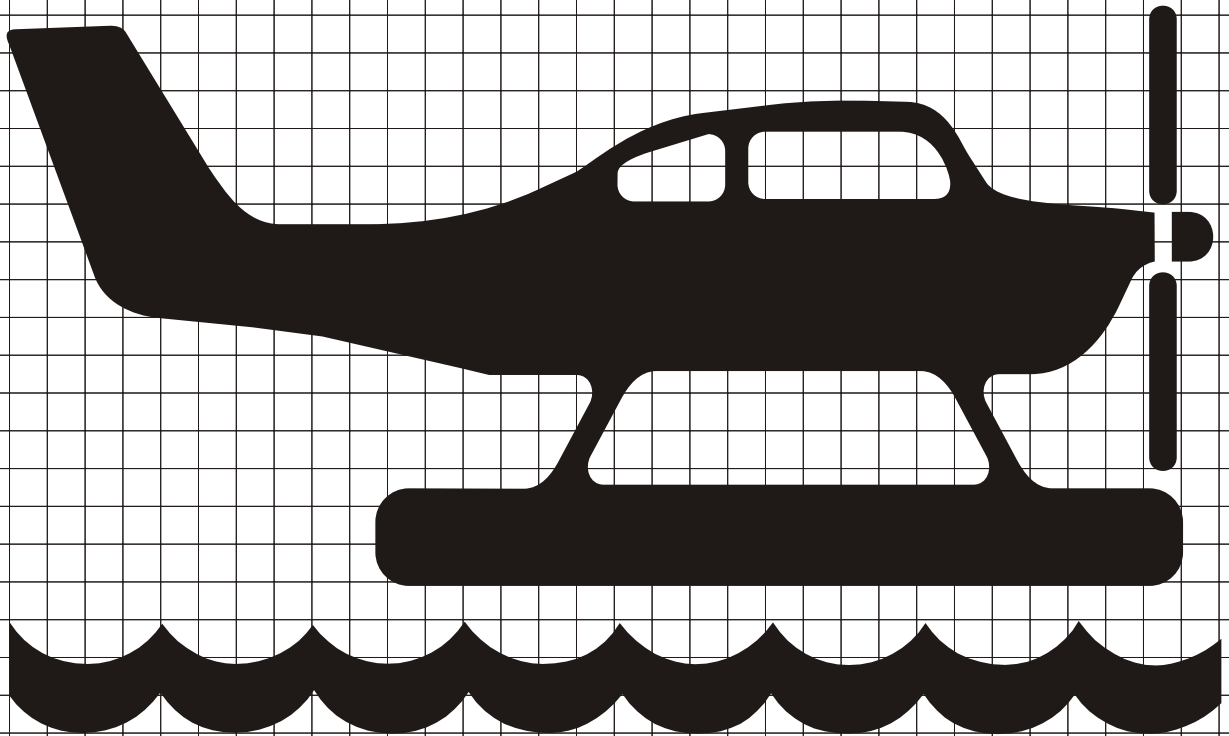

RG-260

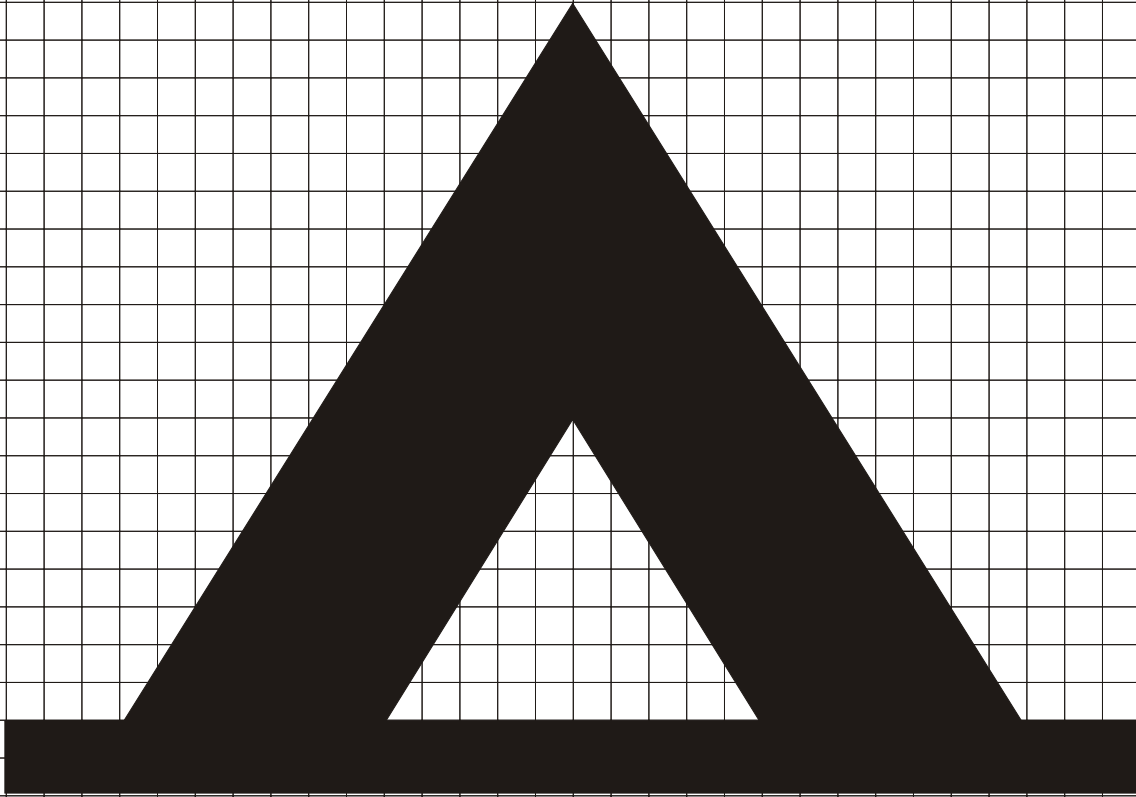

RM-010

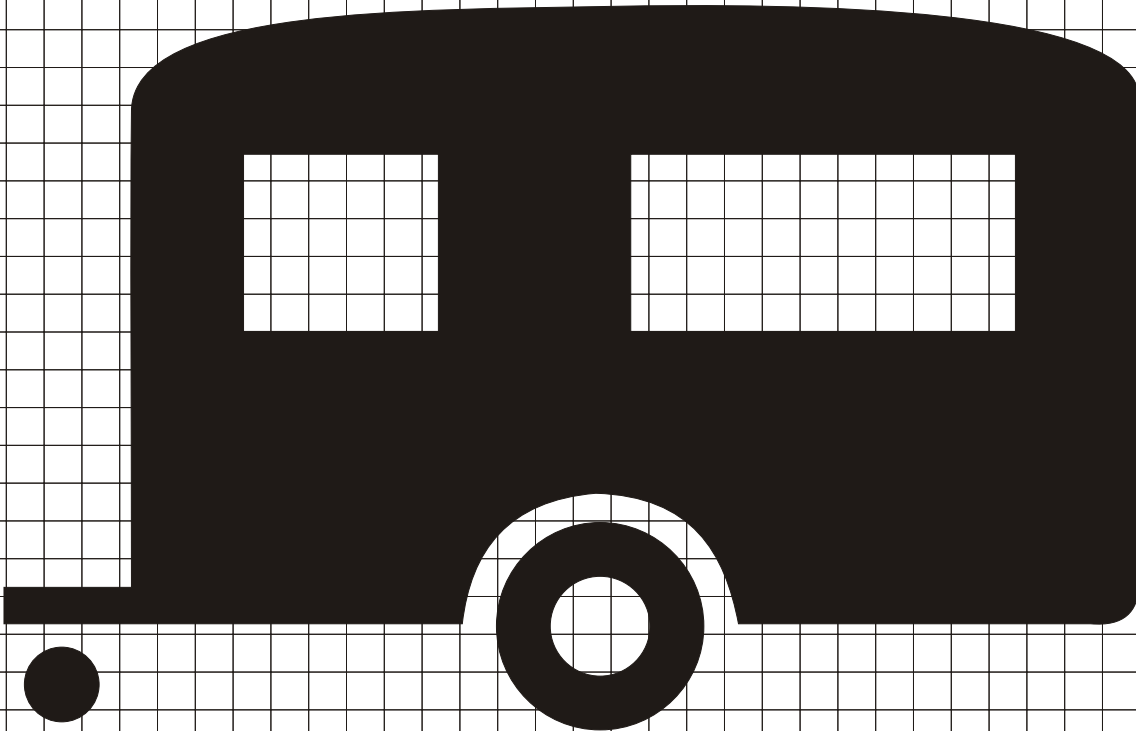

RM-020

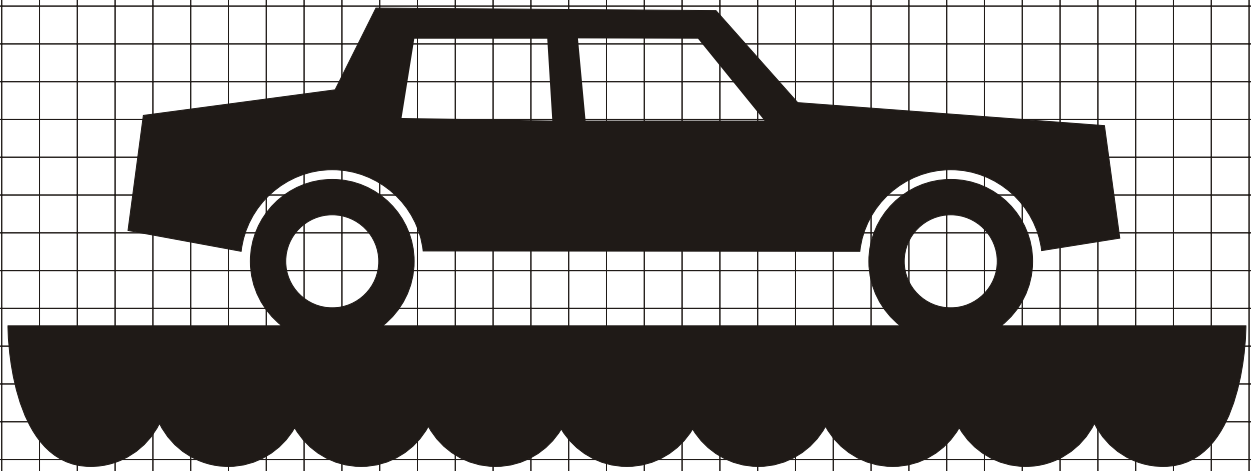

RM-030

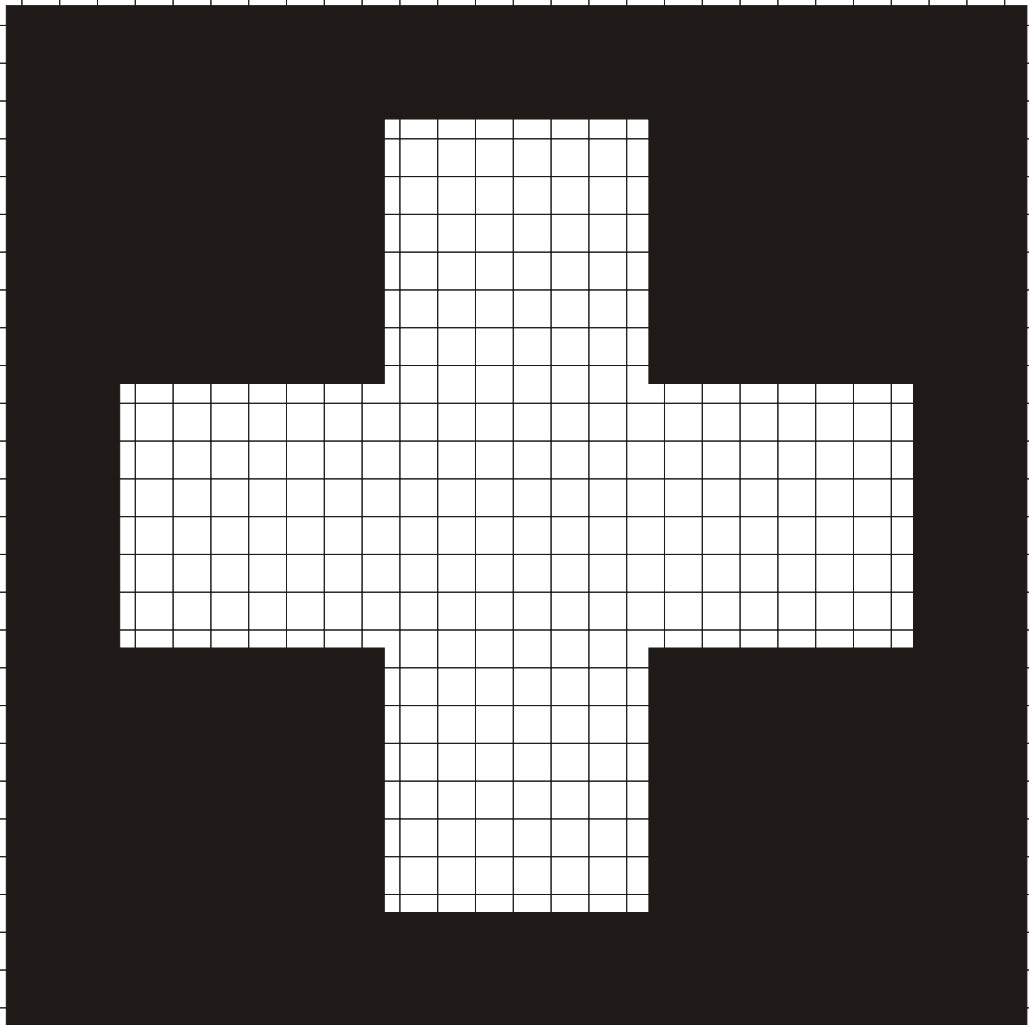

RM-040

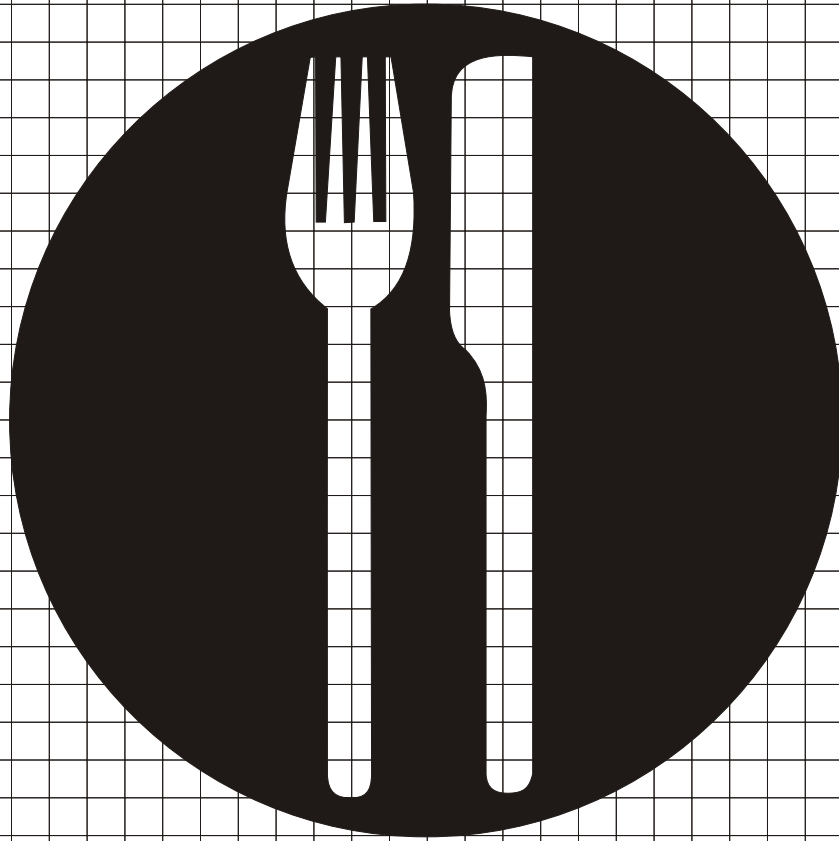

RM-050

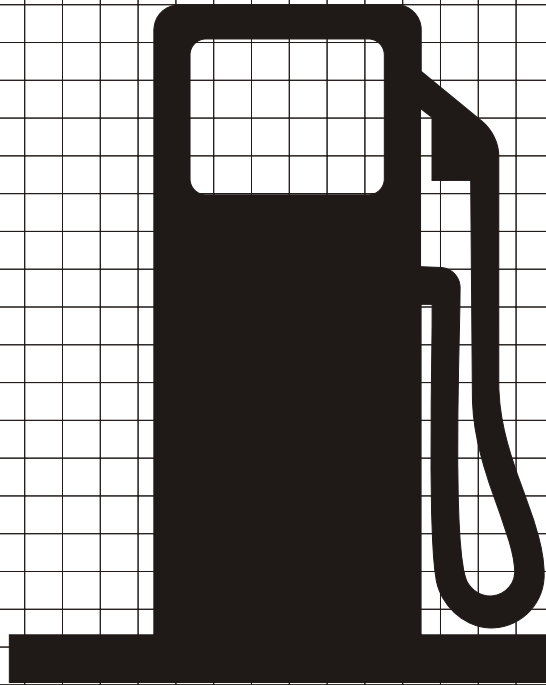

RM-060

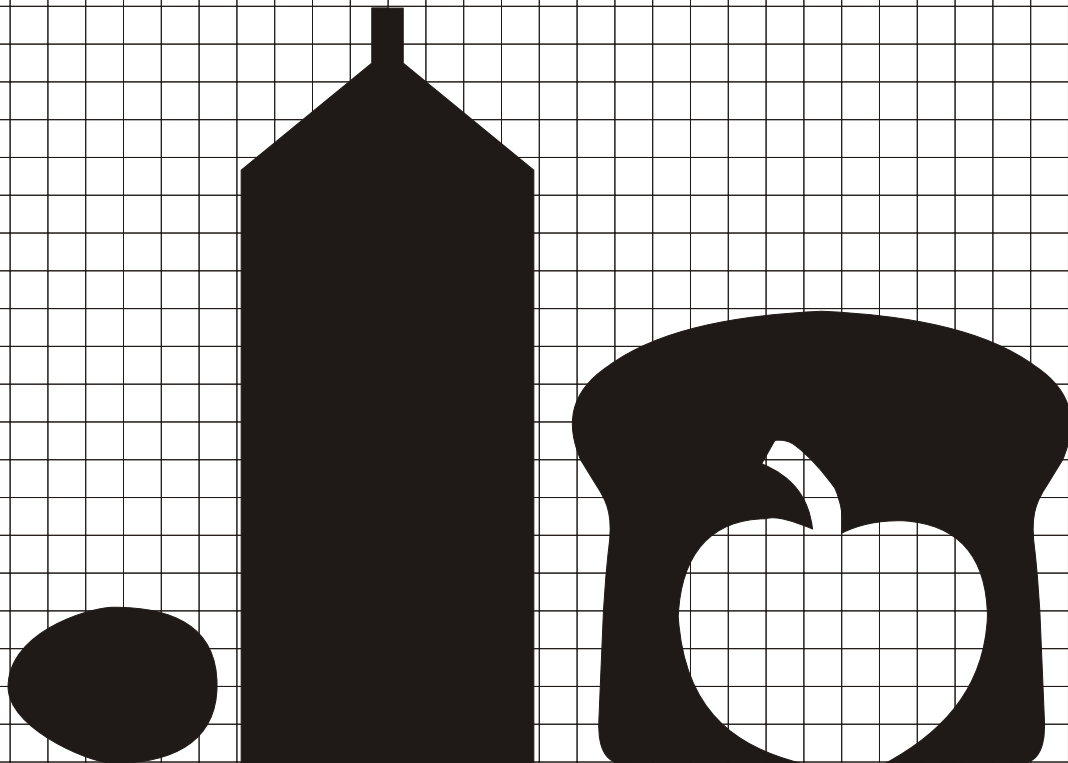

RM-070

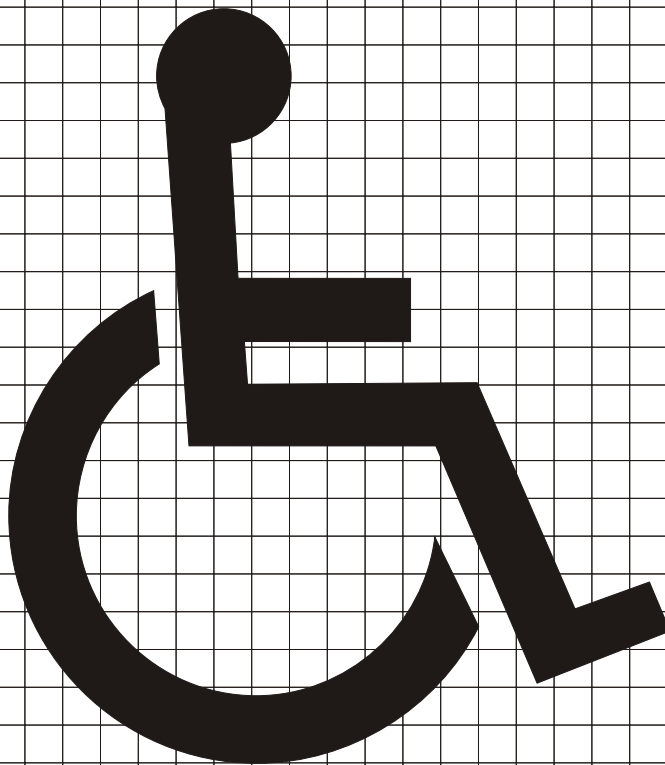

RM-080

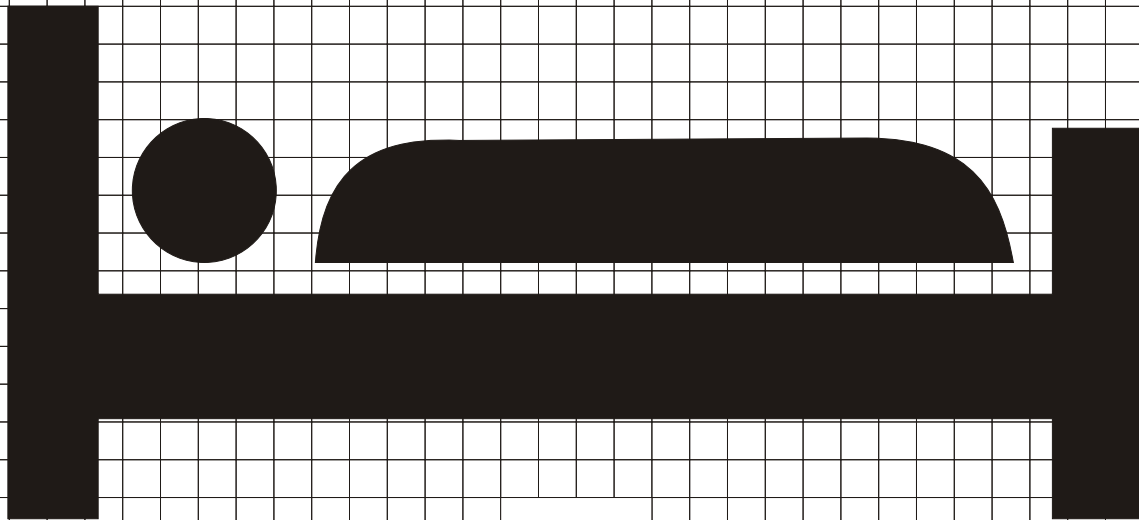

RM-090

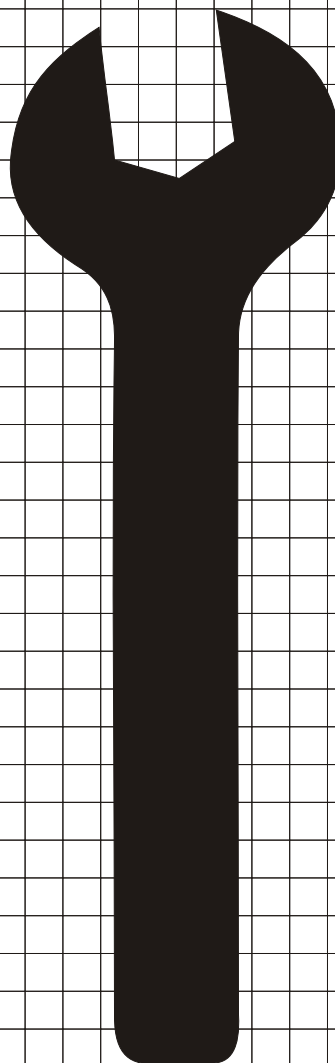

RM-100

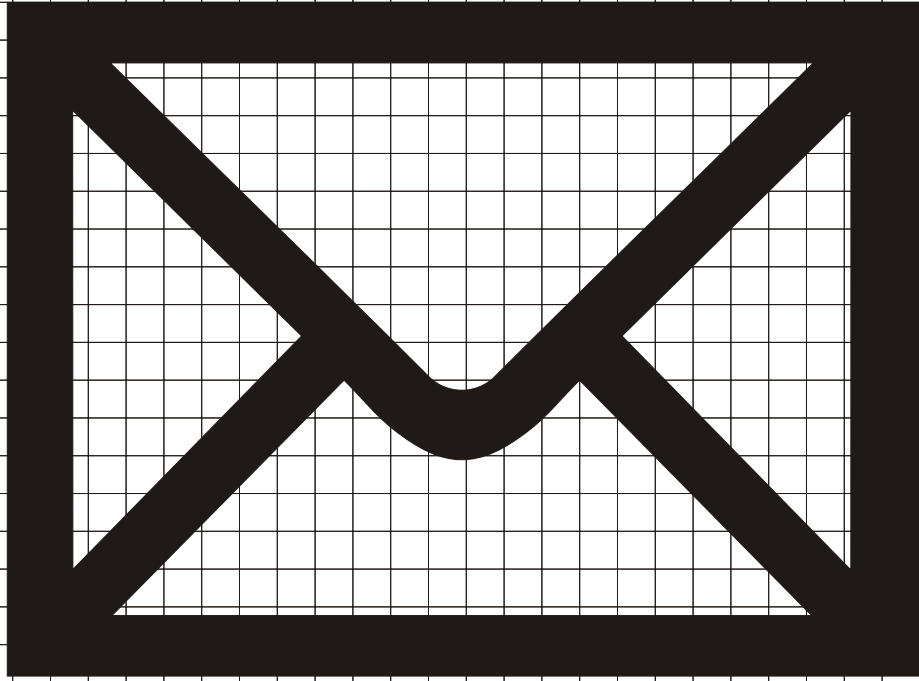

RM-110

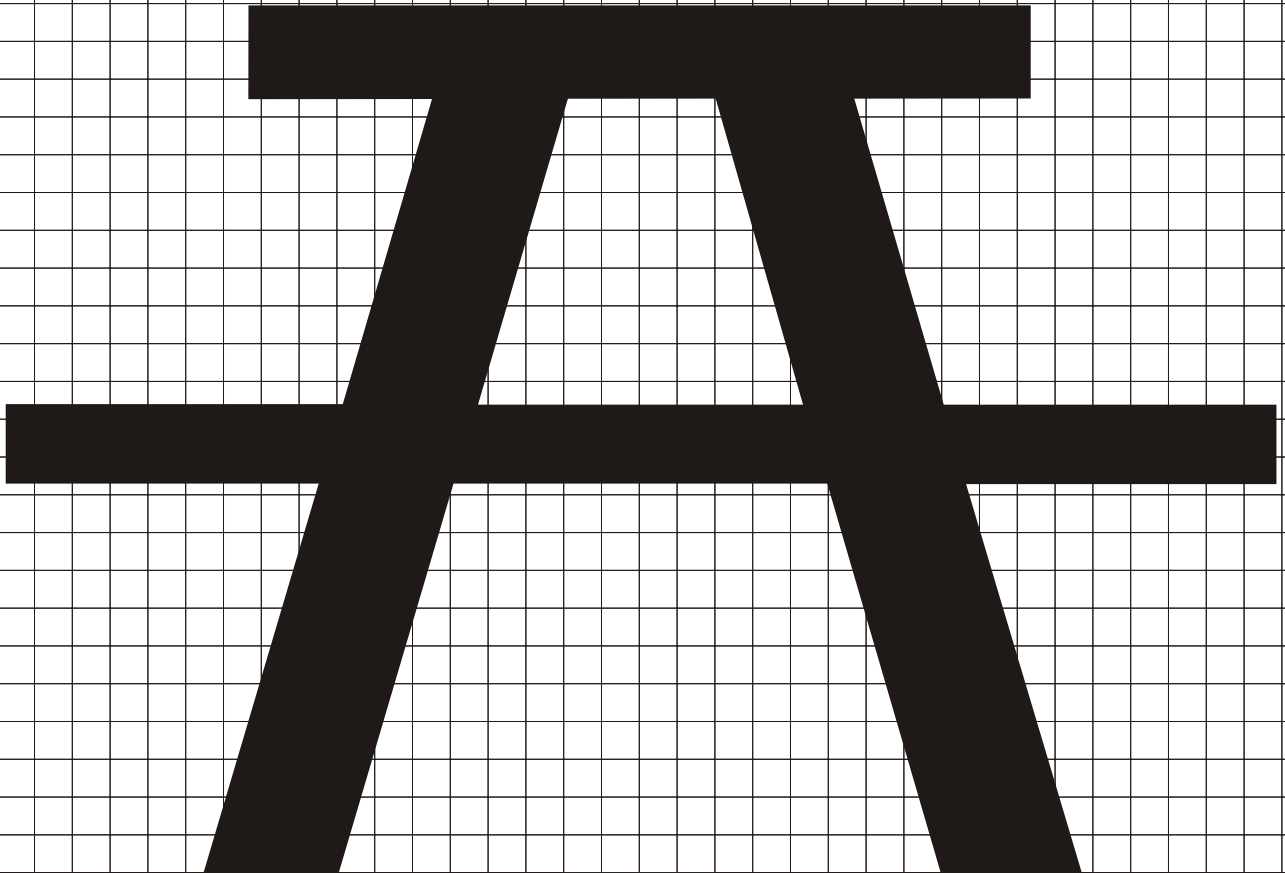

RM-120

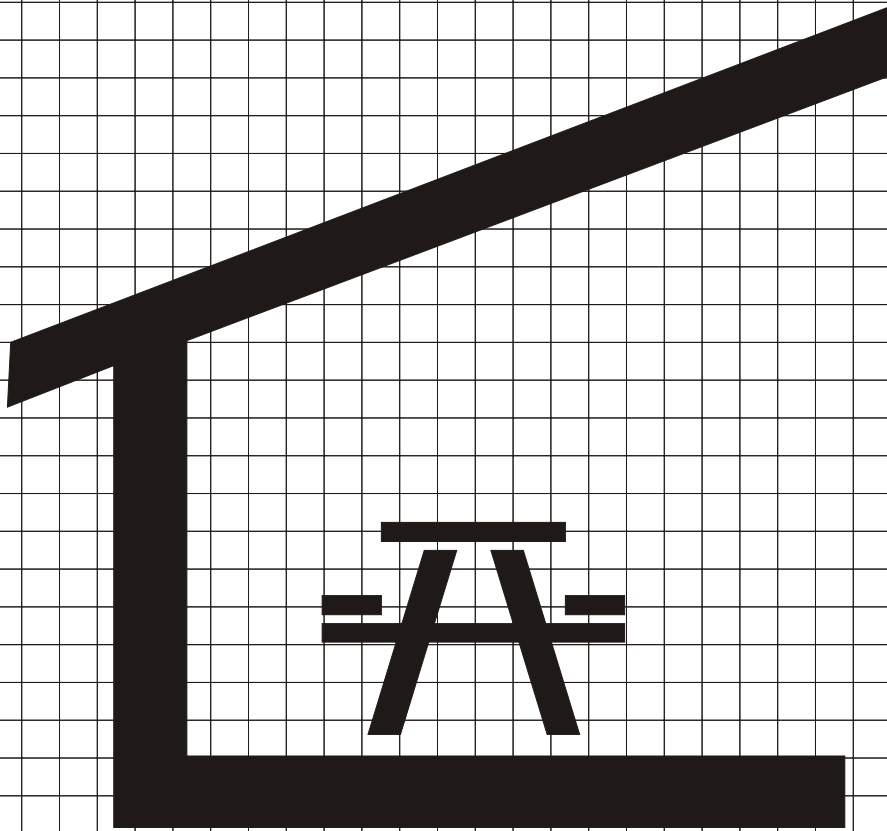

RM-130

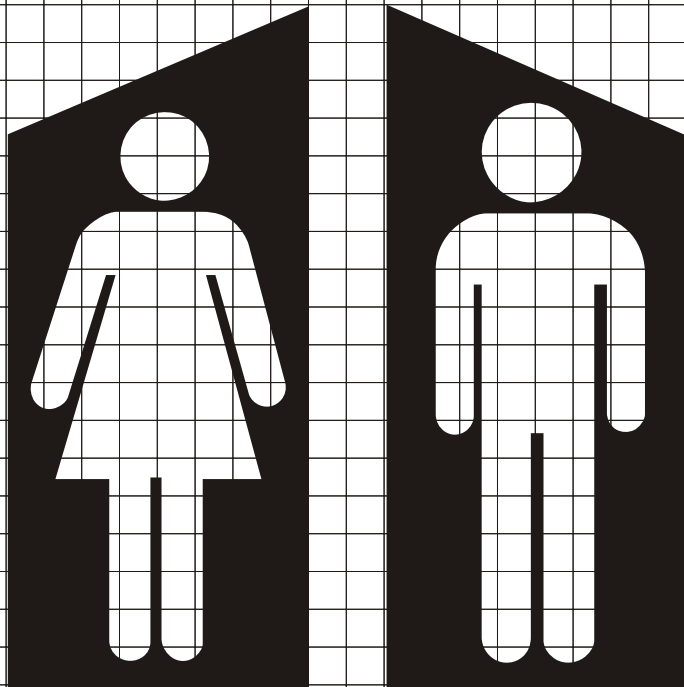

RM-140

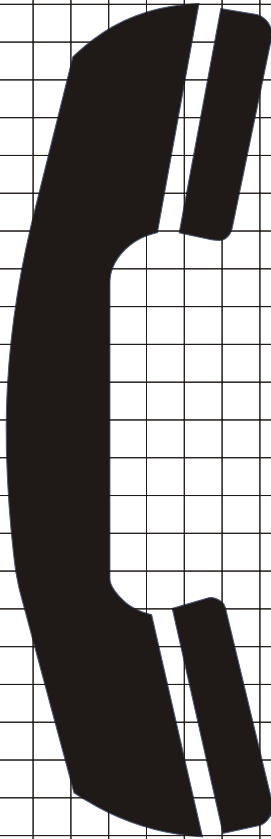

RM-150

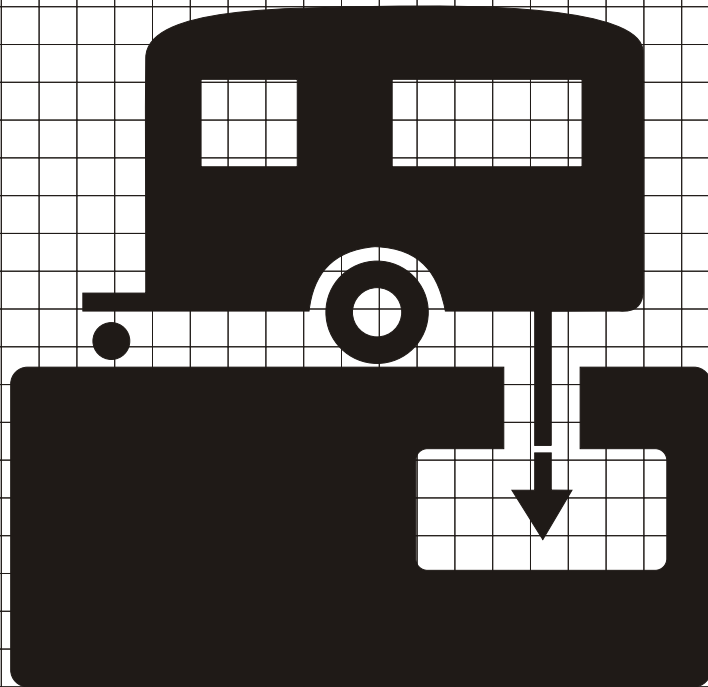

RM-160

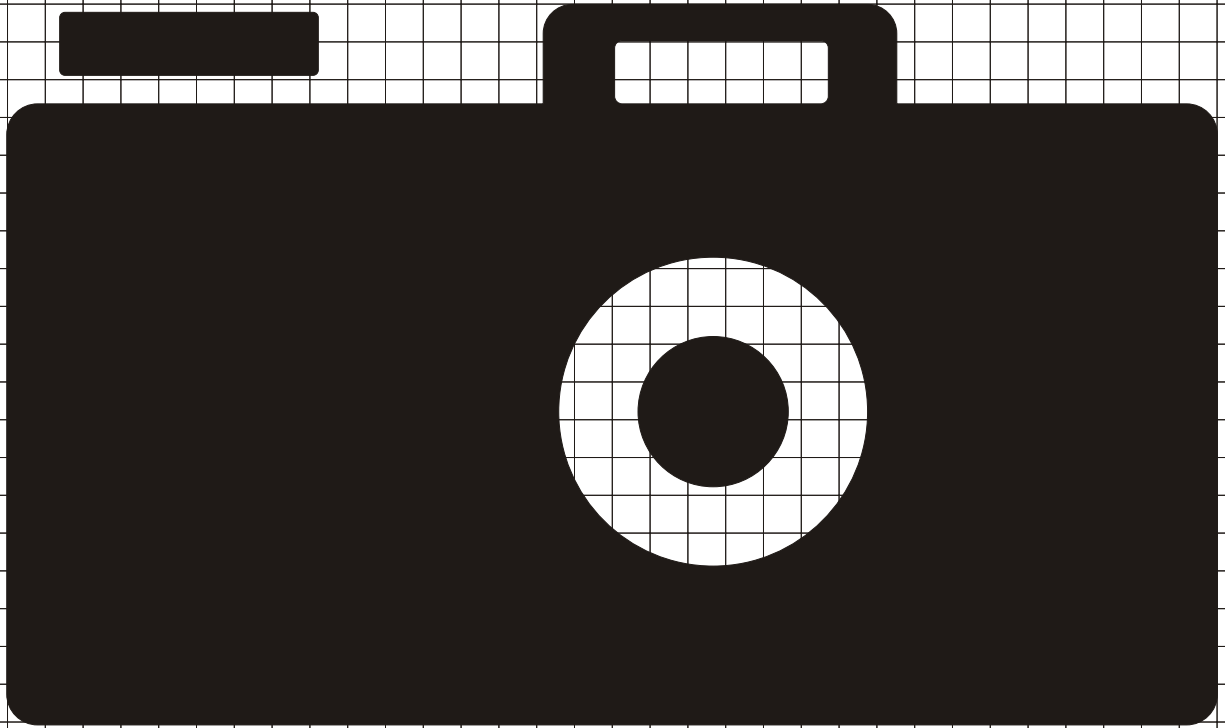

RM-170

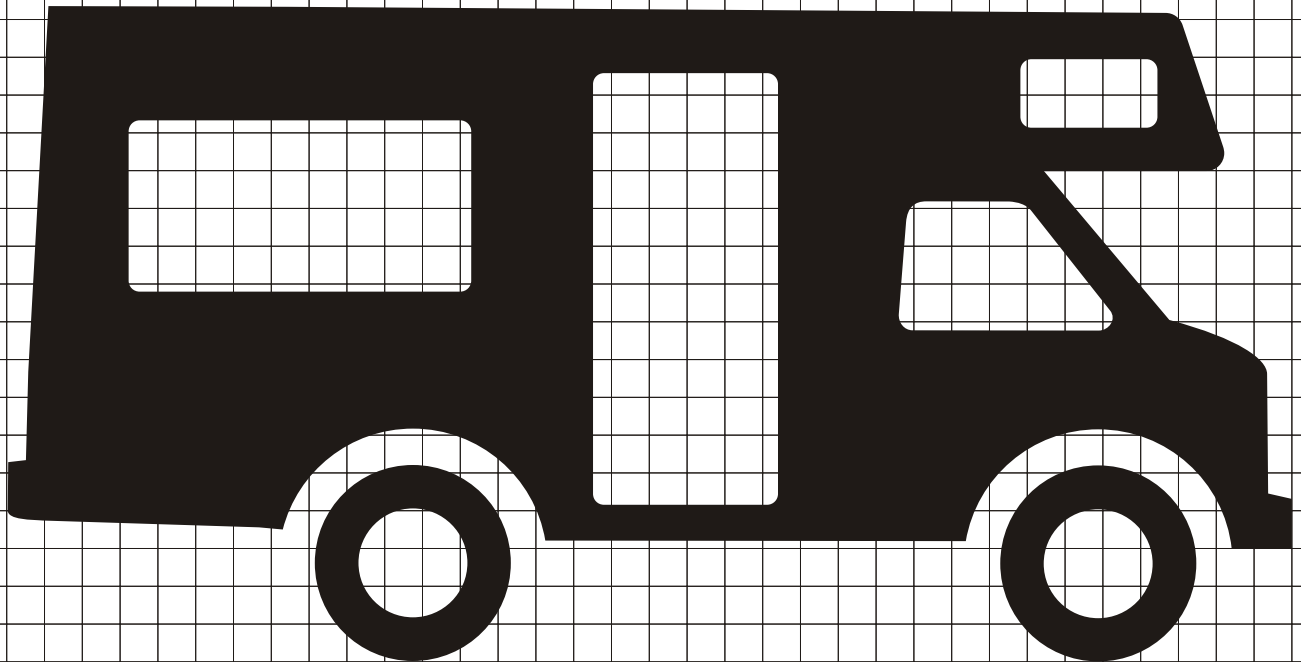

RM-200

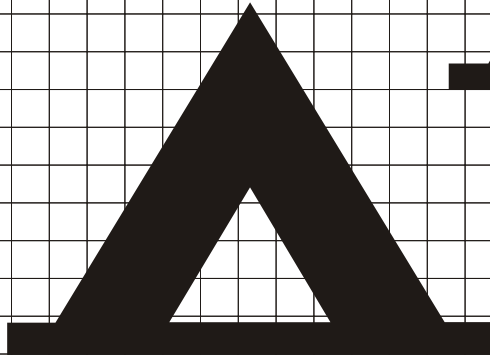
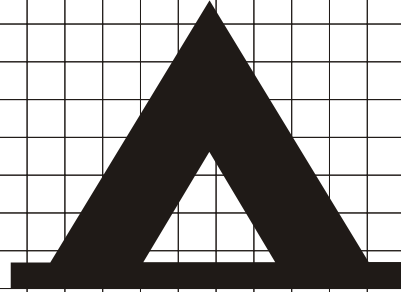
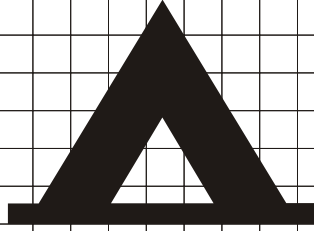

RM-210

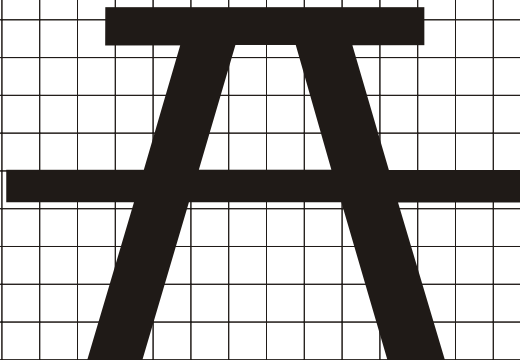
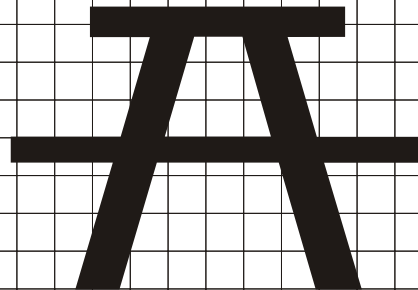
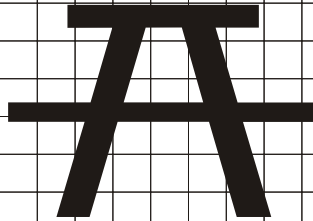

RM-220

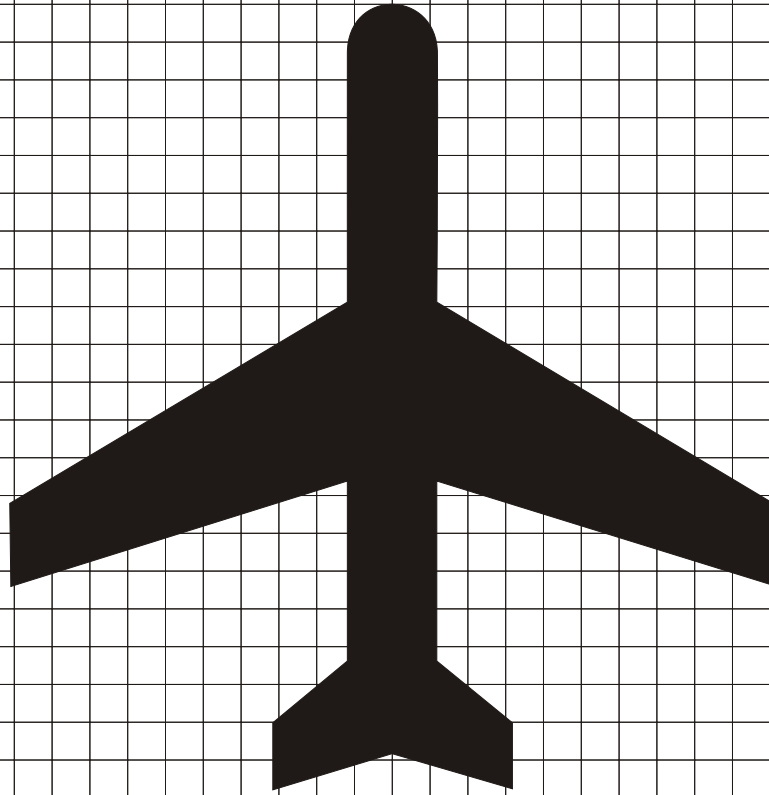

RA-010

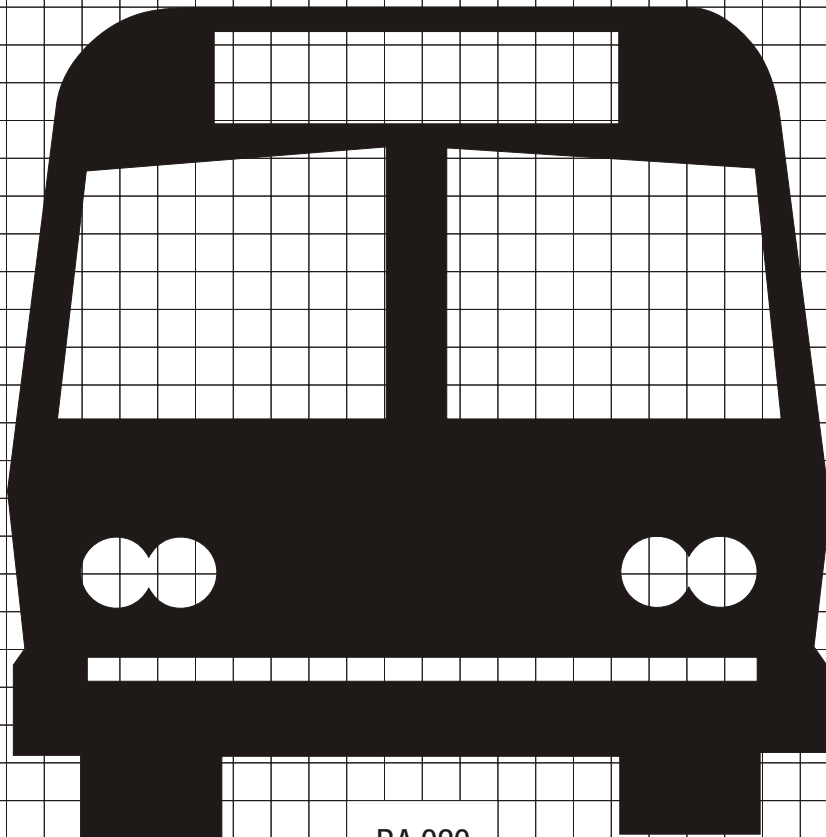

RA-020

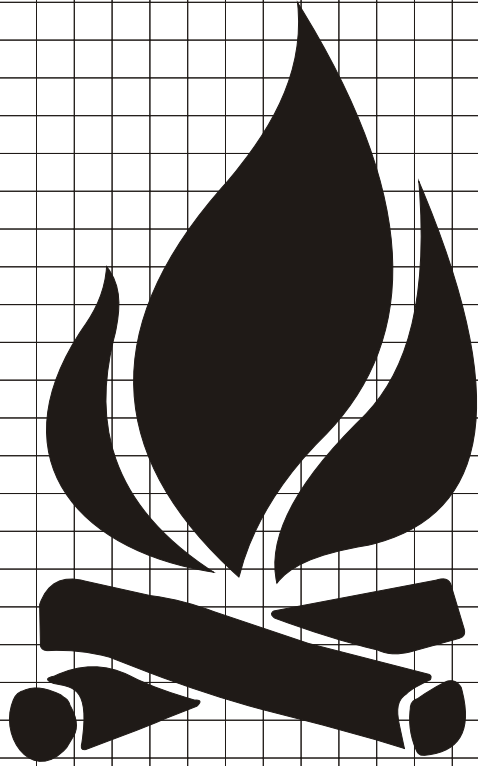

RA-030

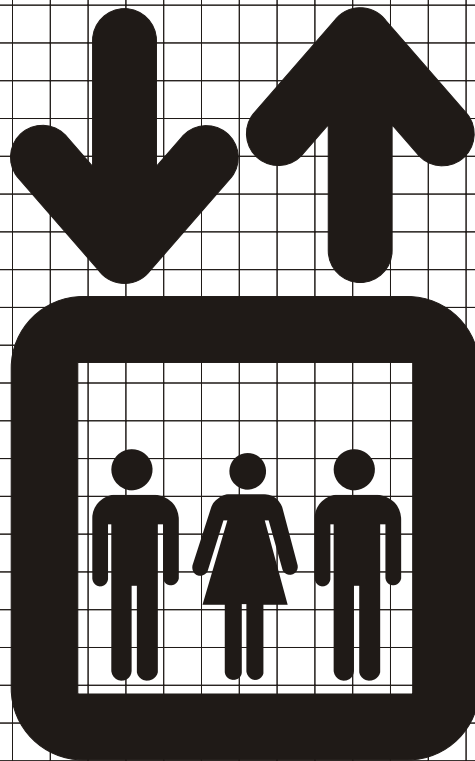

RA-040



RA-050

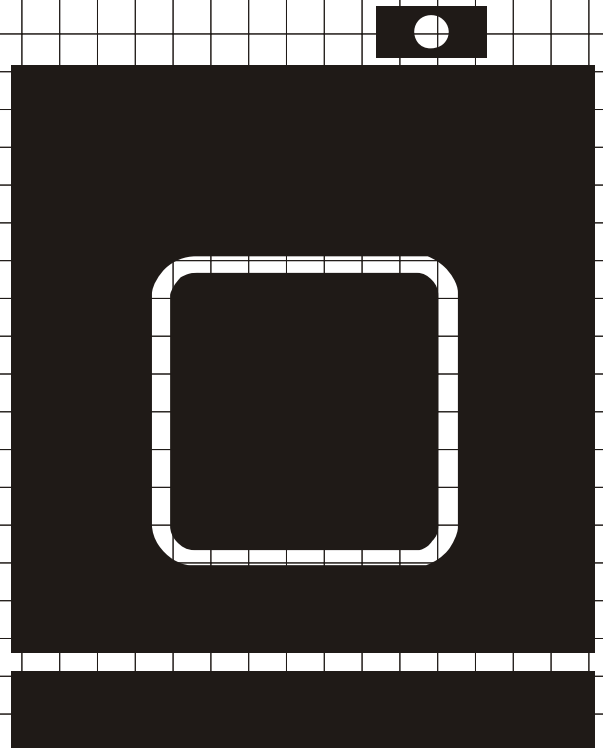
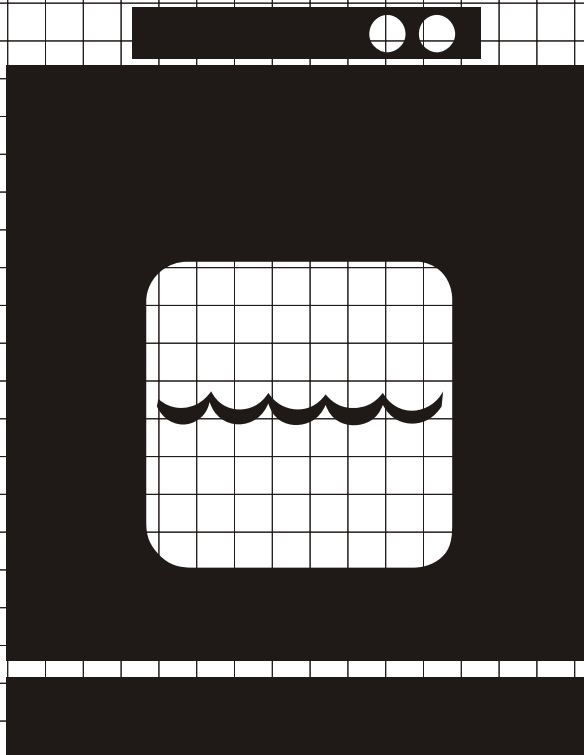

RA-060

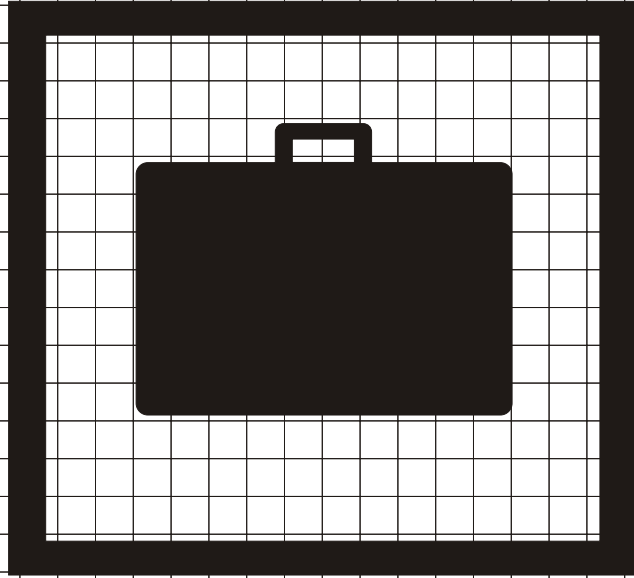
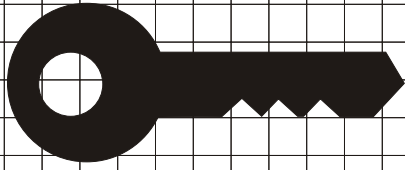

RA-070

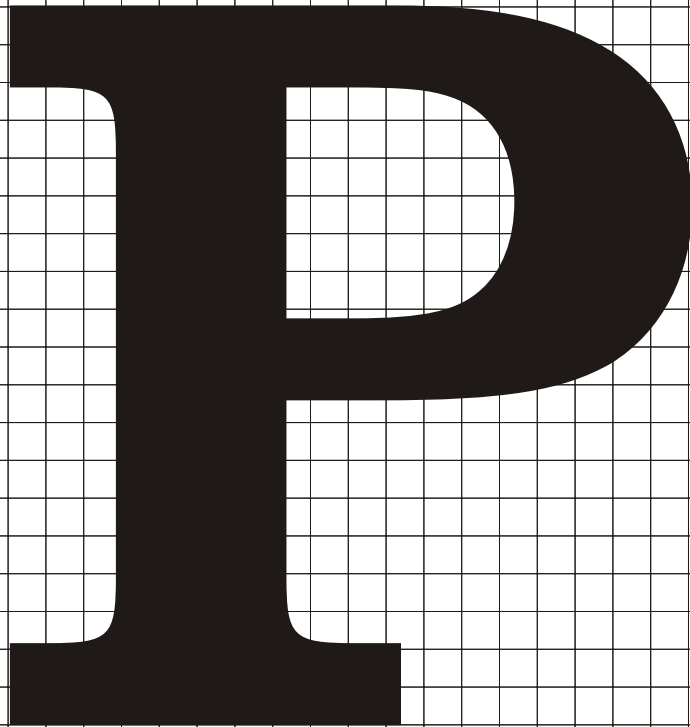

RA-080

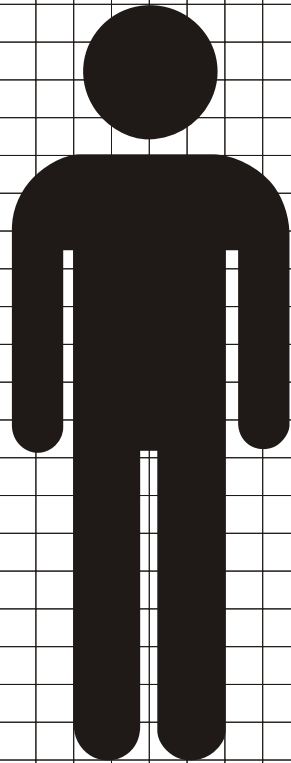

RA-090

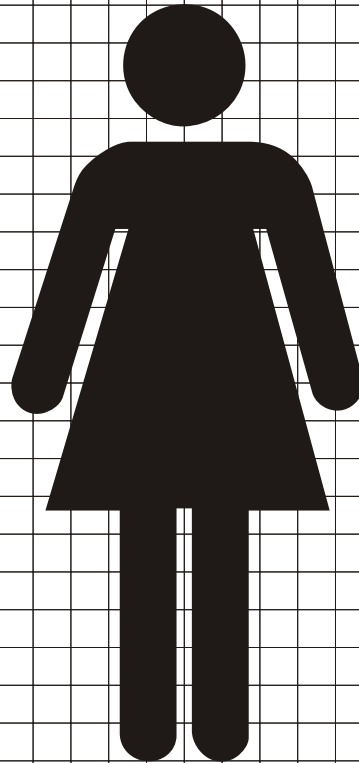

RA-100

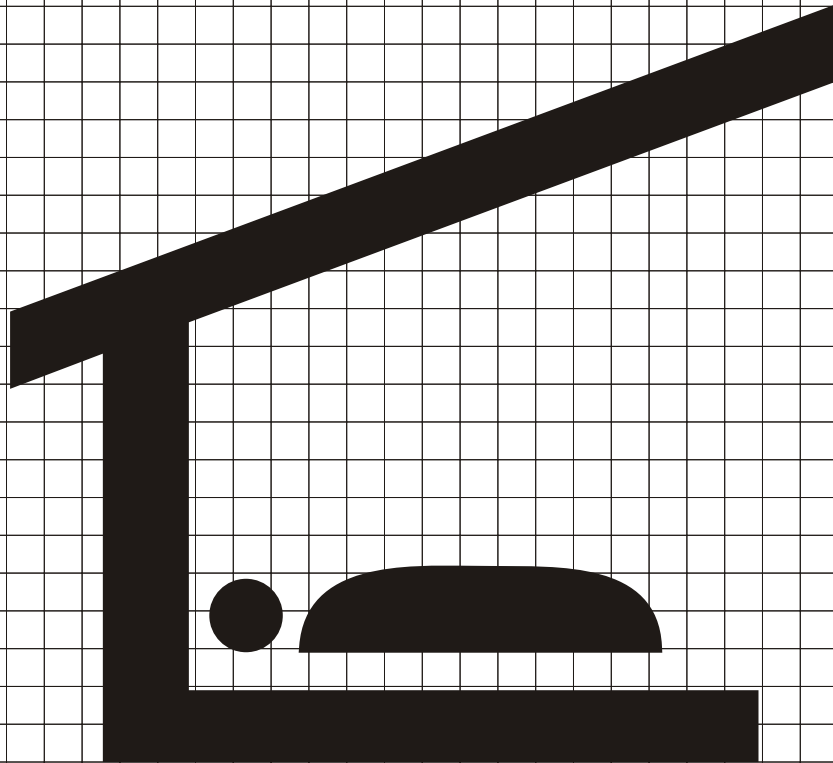

RA-110

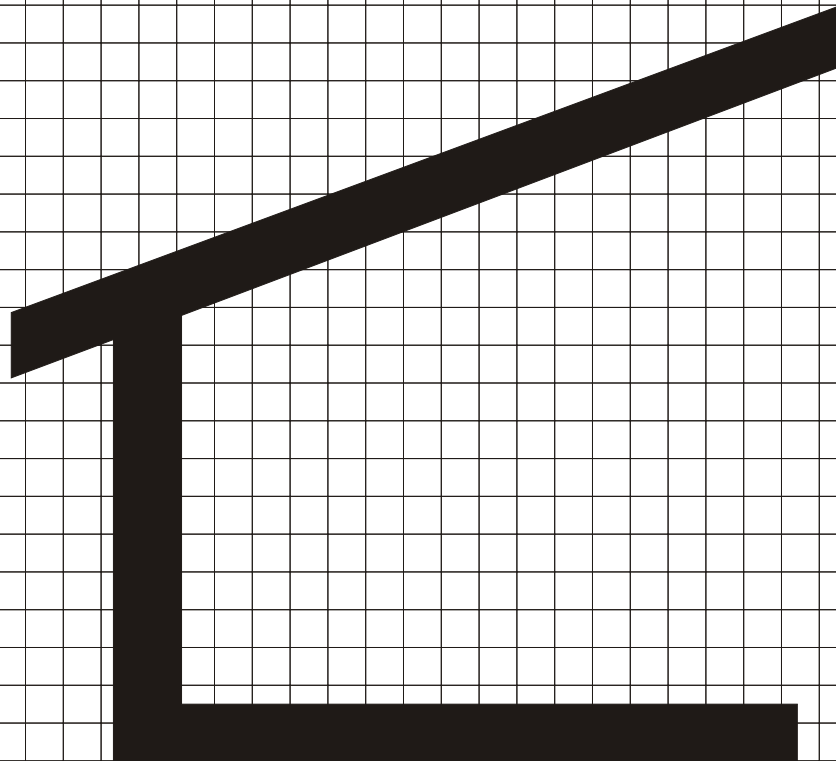

RA-120

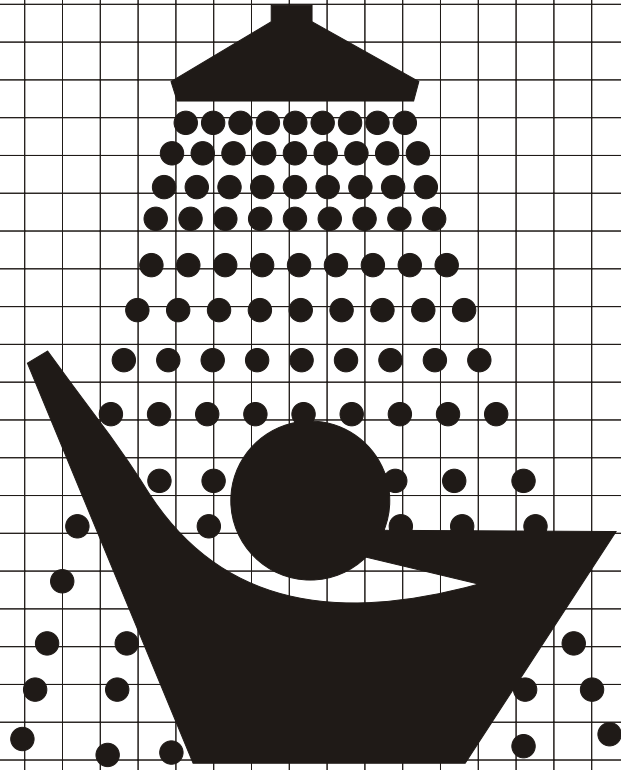

RA-130

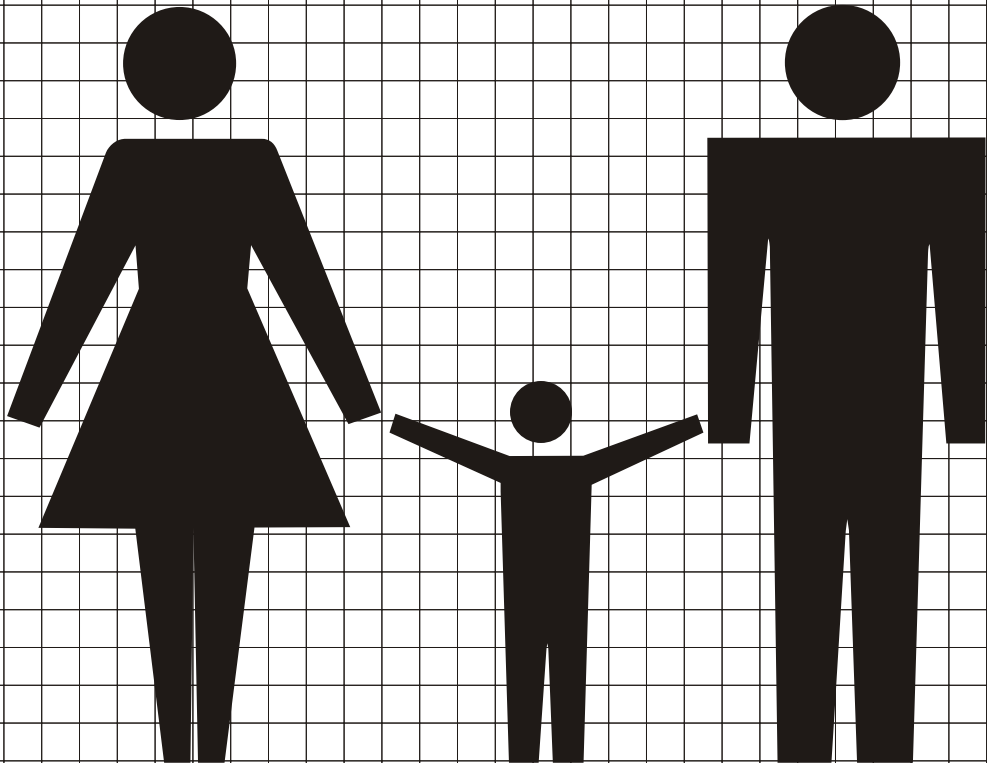

RA-150

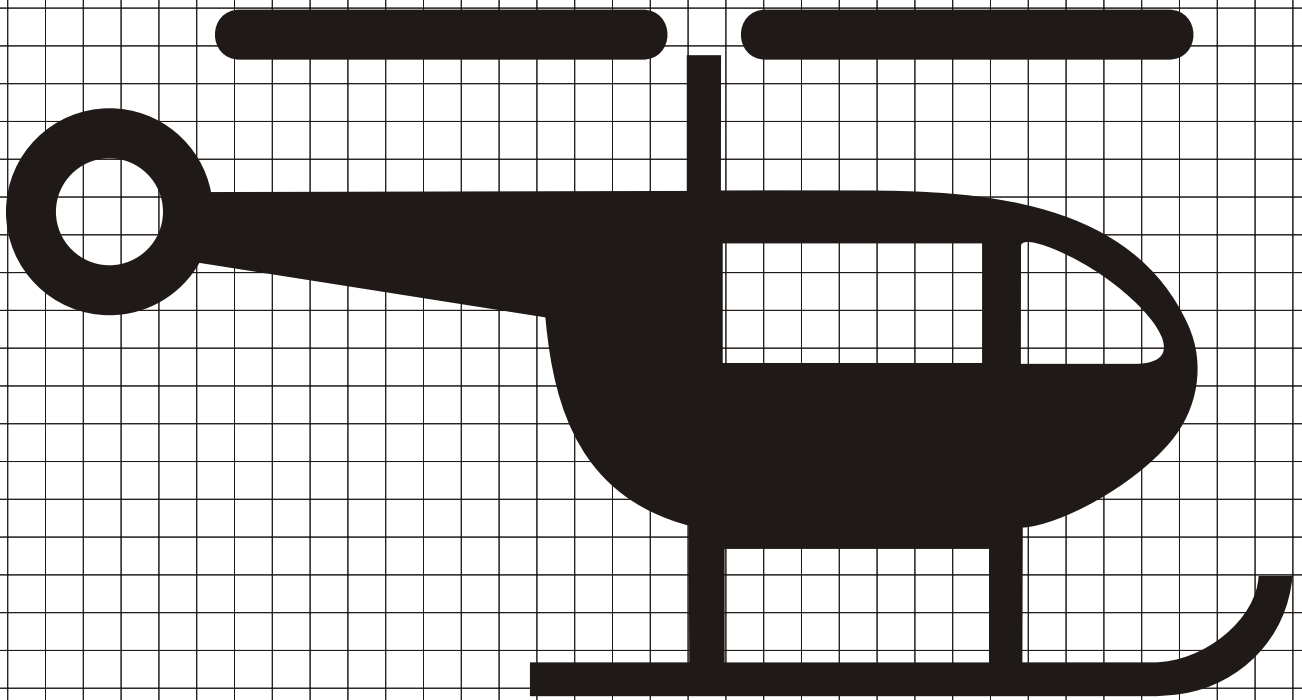

RA-160

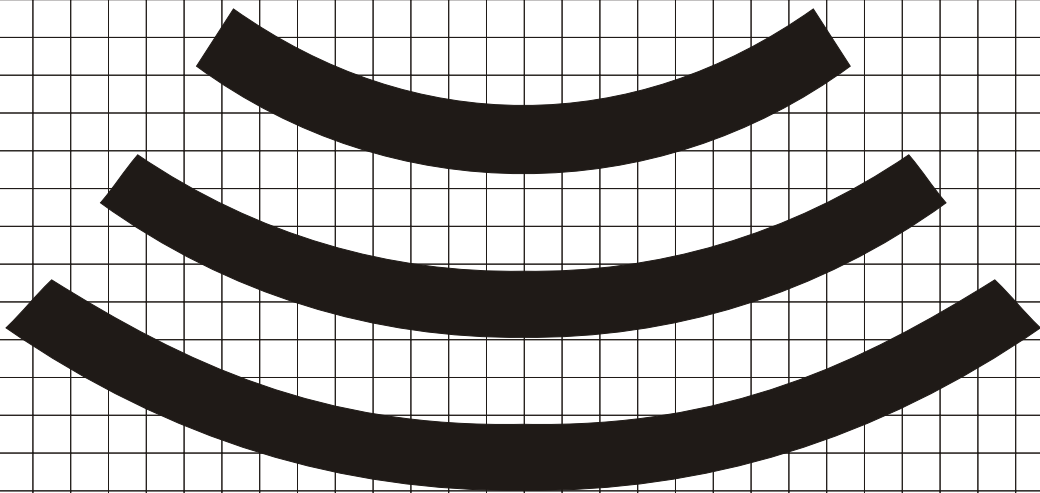

RL-010

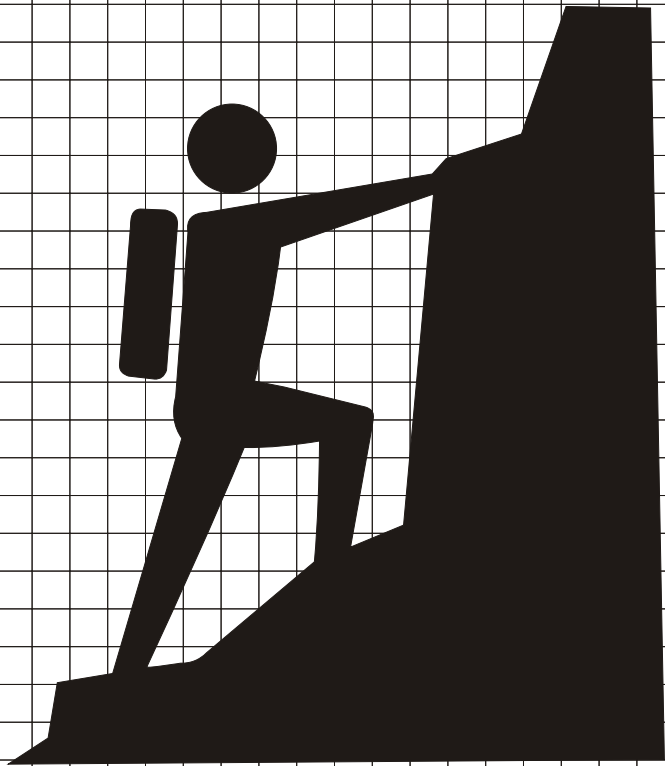

RL-020



RL-030

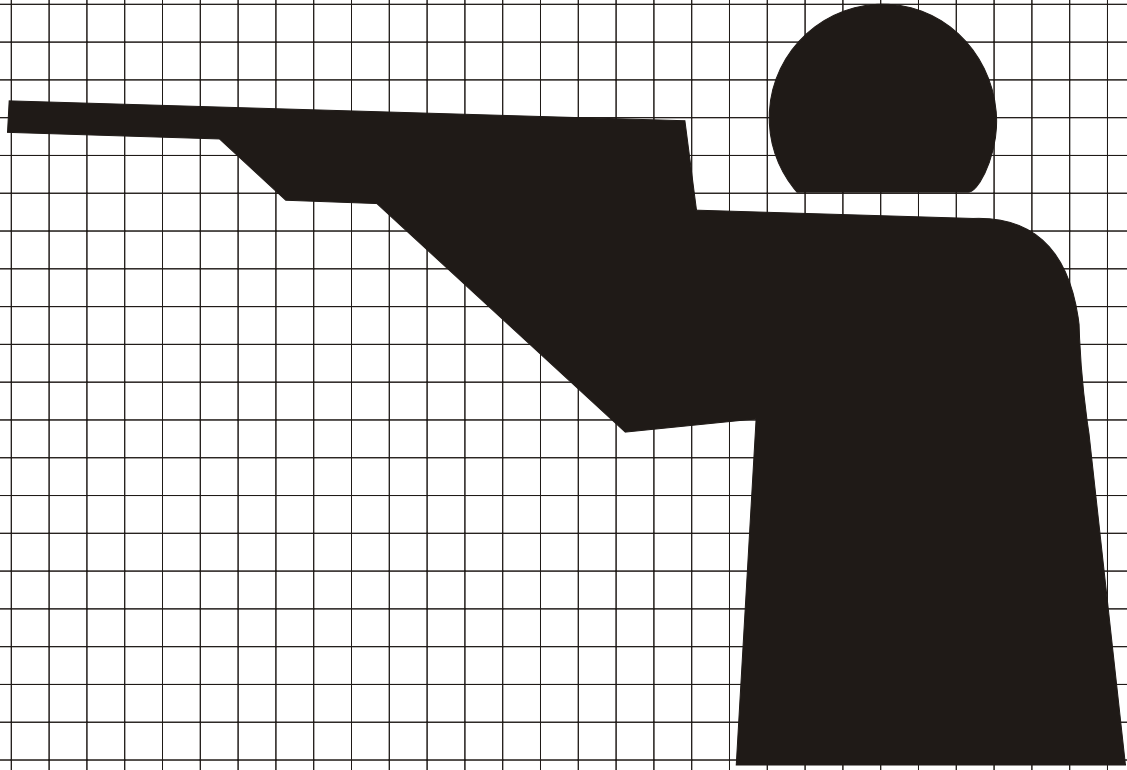

RL-040

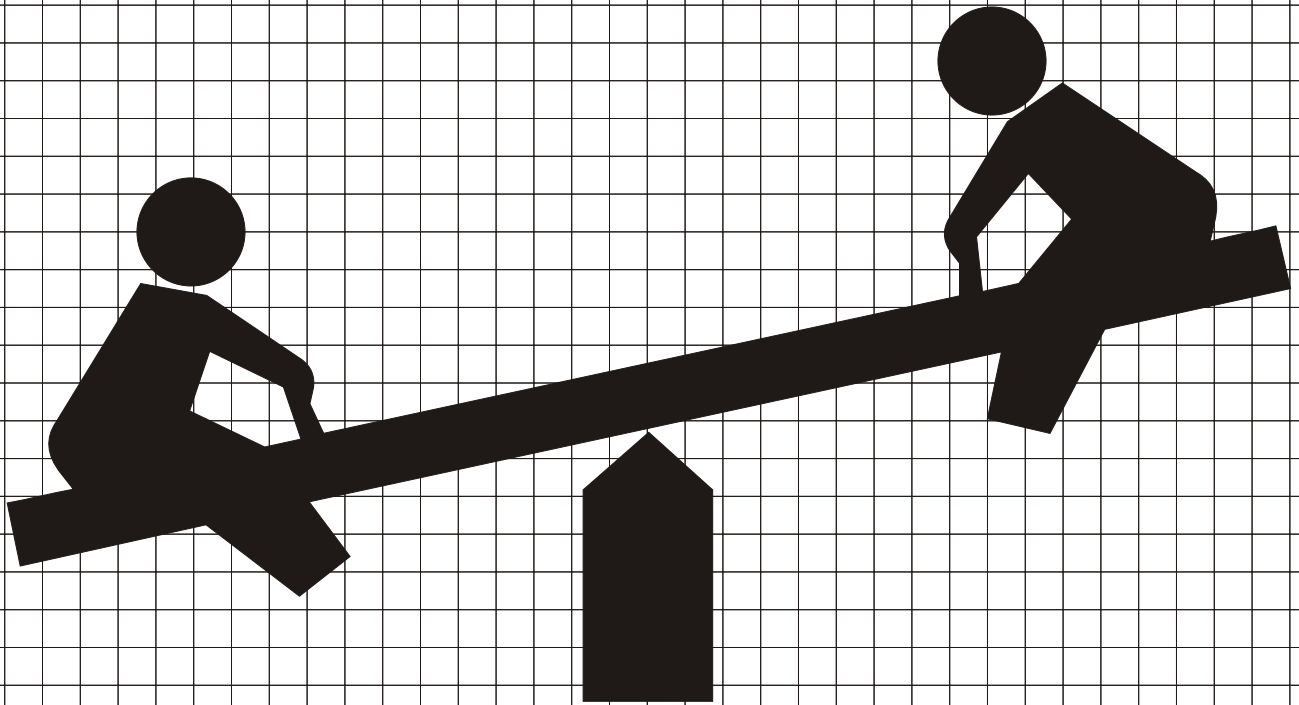

RL-050

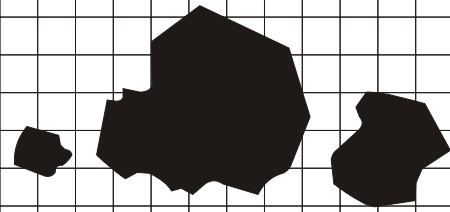
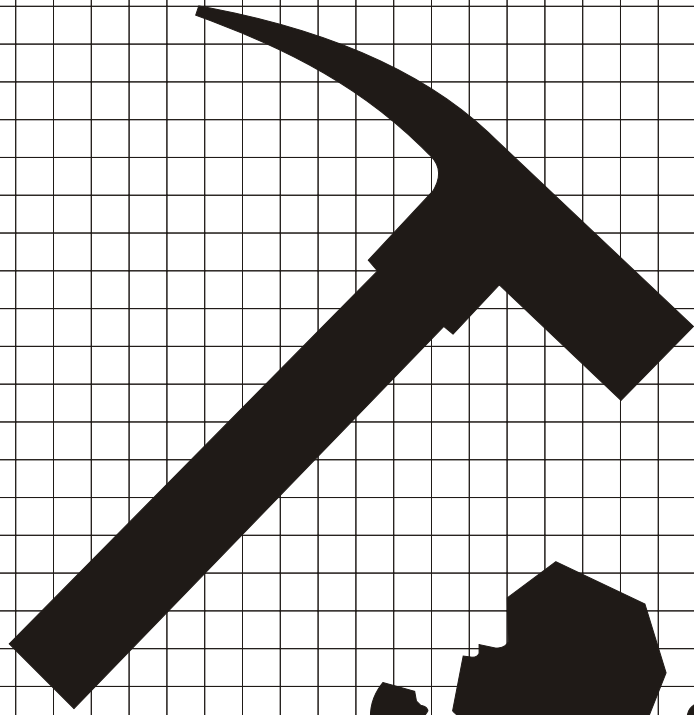

RL-060

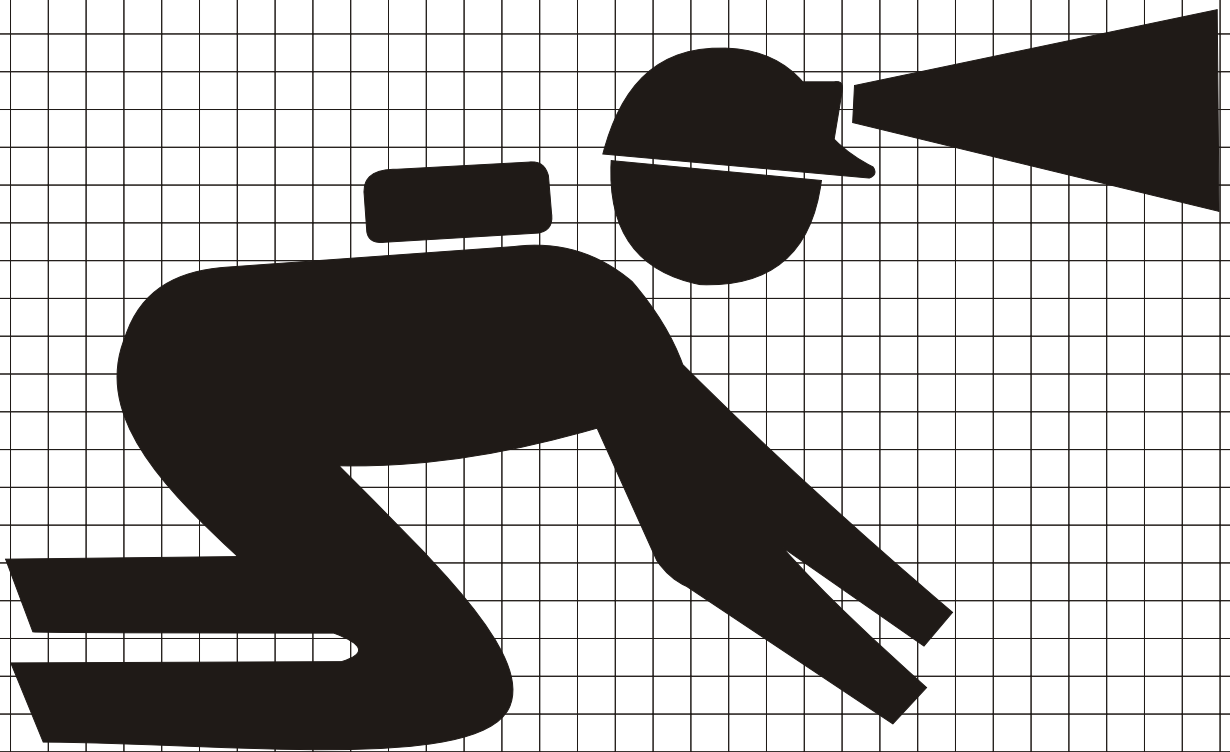

RL-070

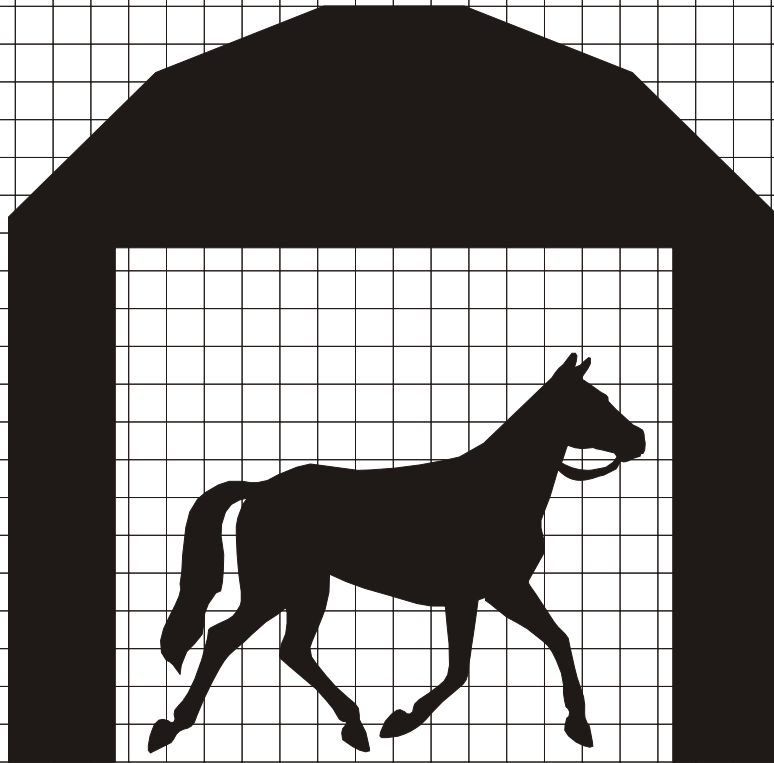

RL-080

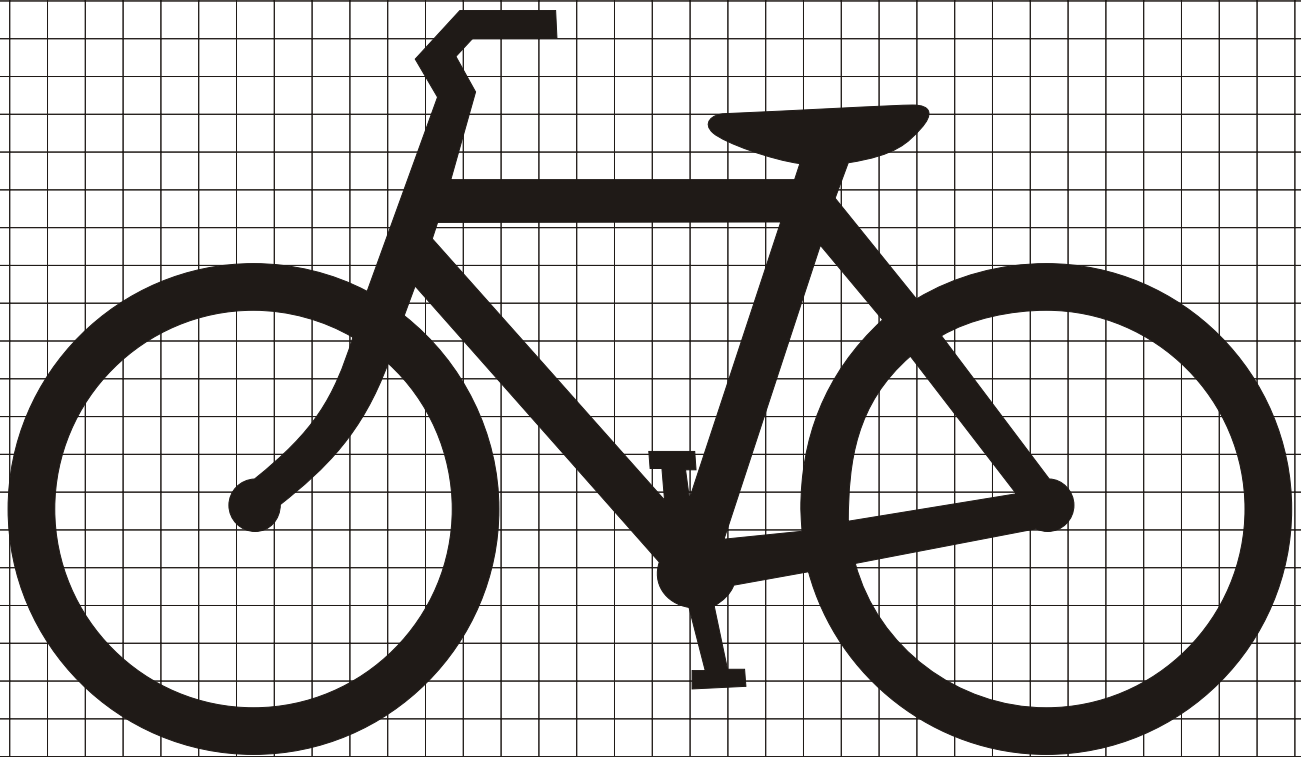

RL-090



RL-100

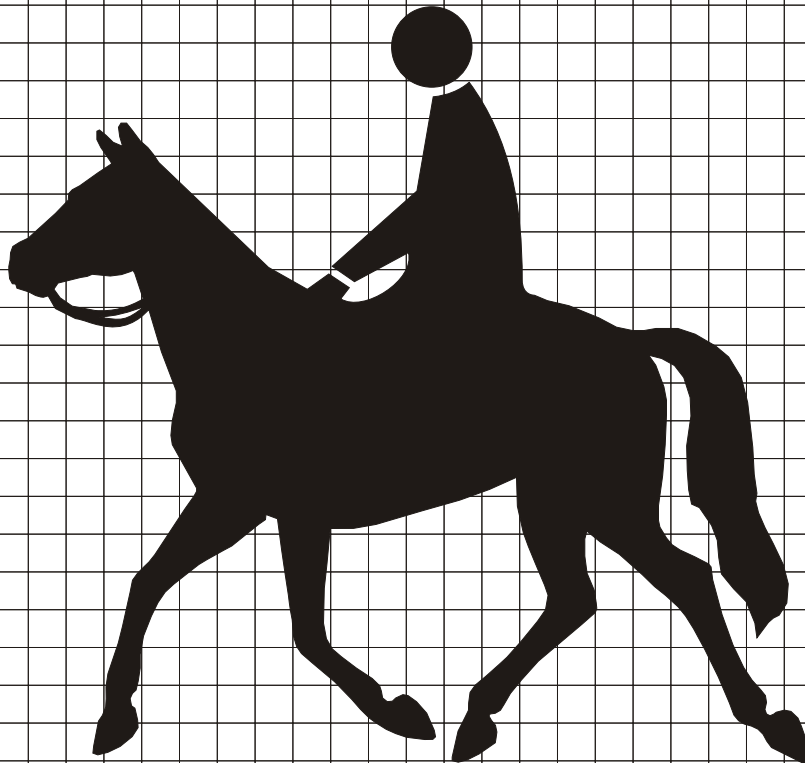

RL-110

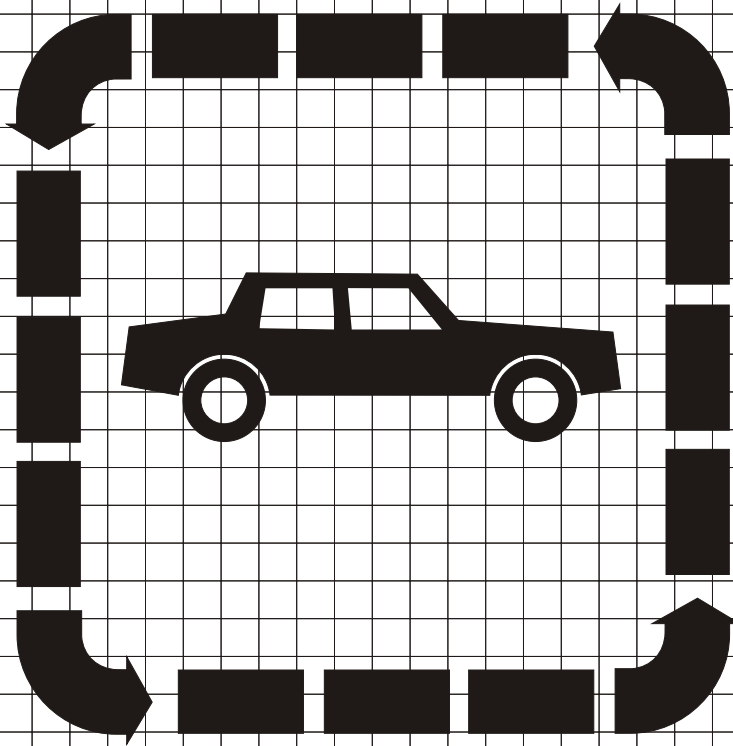

RL-120



RL-130

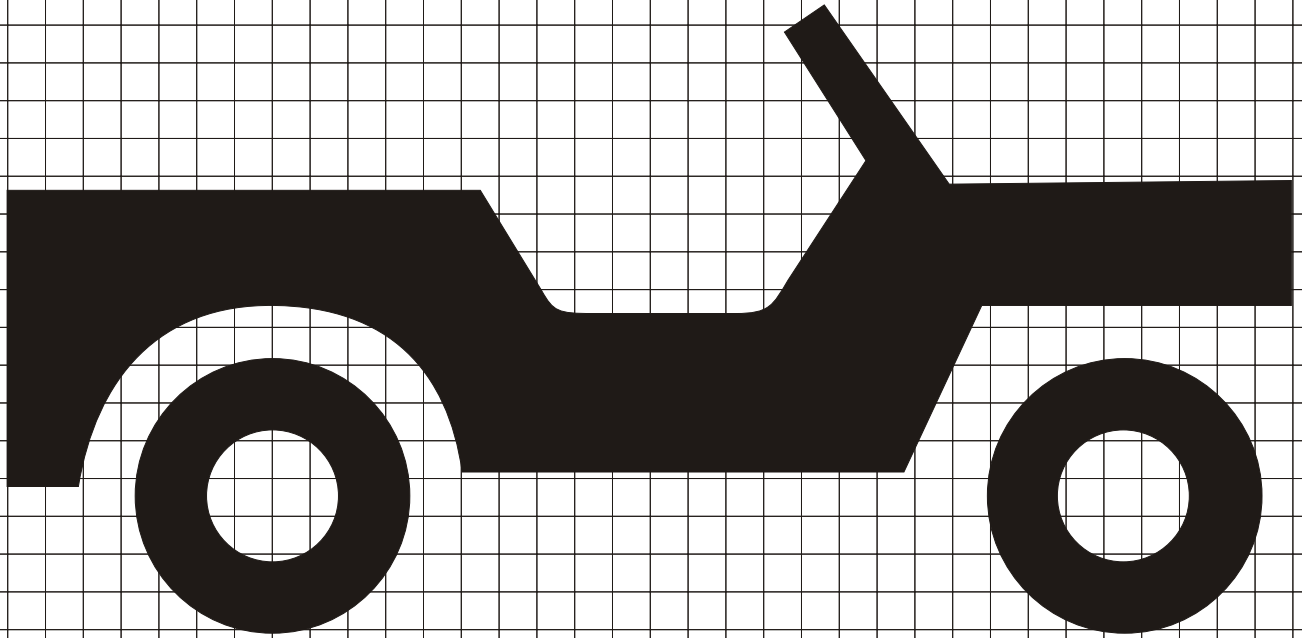

RL-140

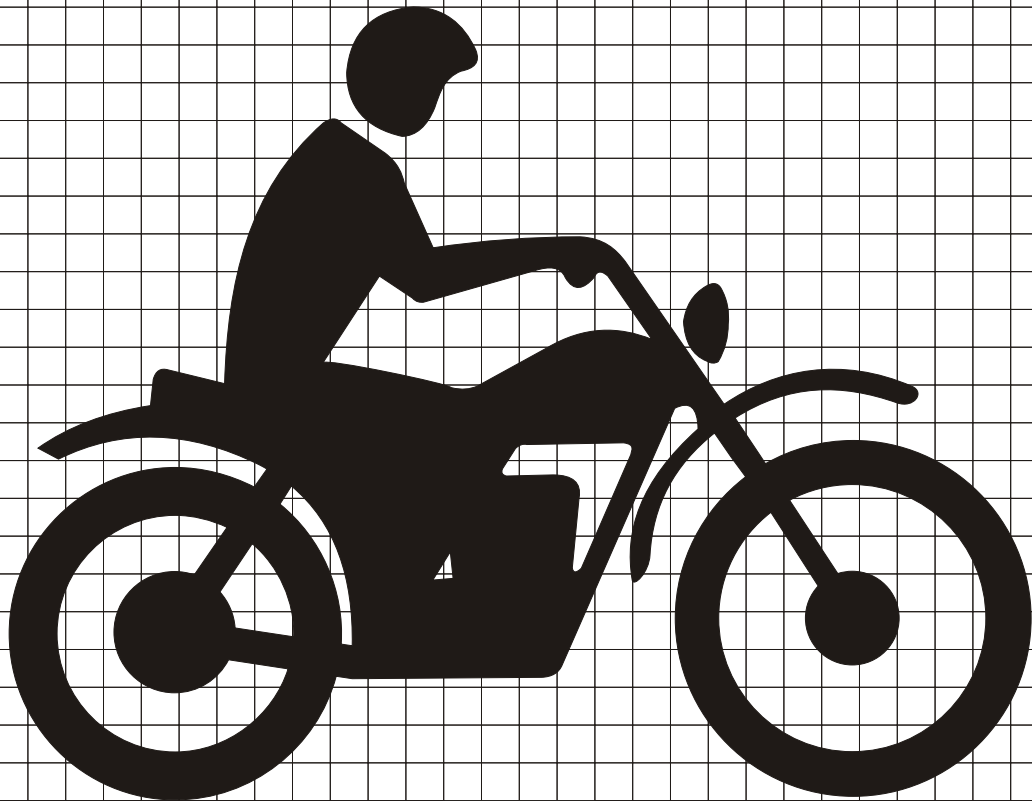

RL-150

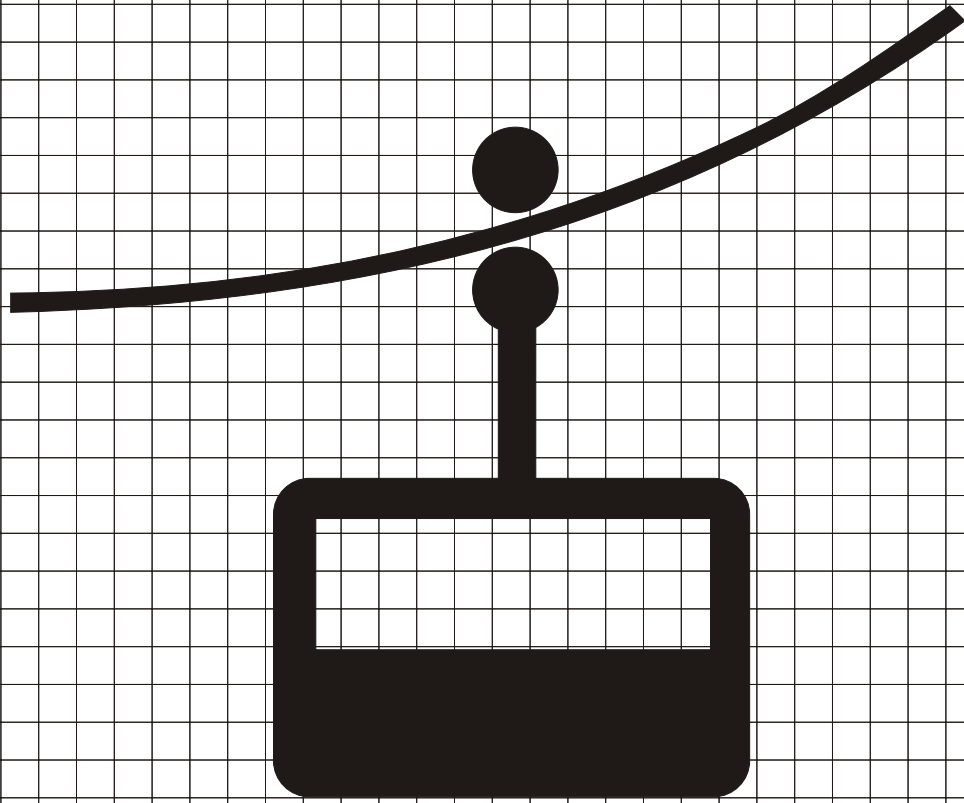

RL-160

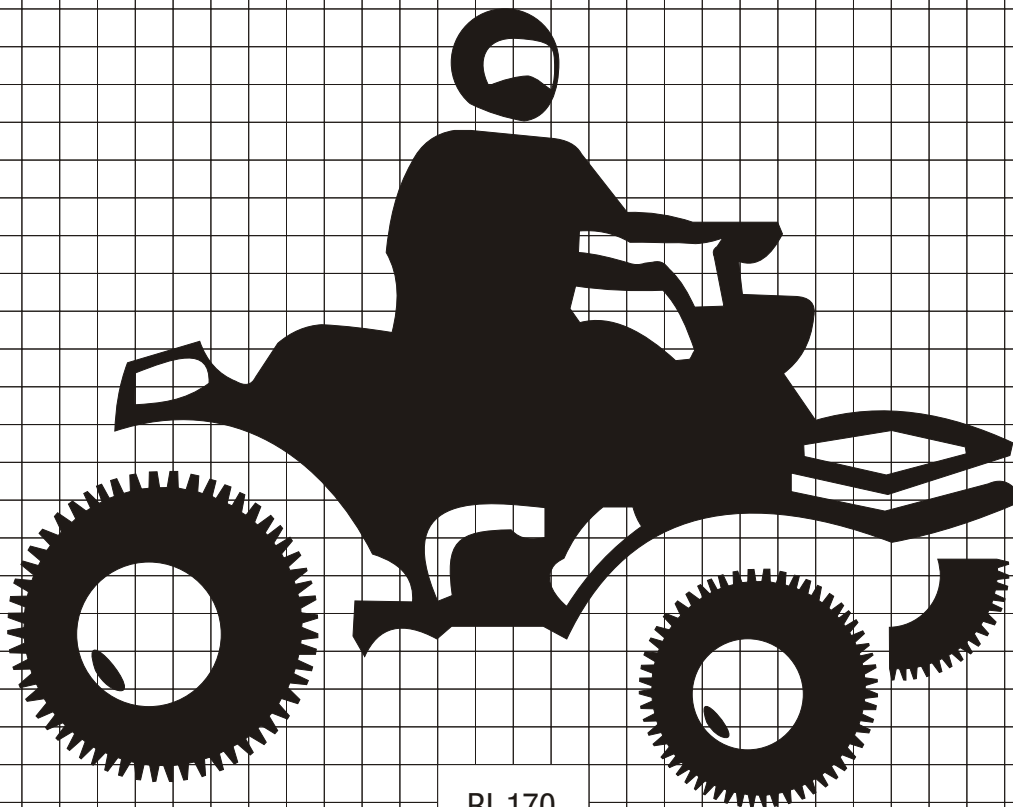

RL-170

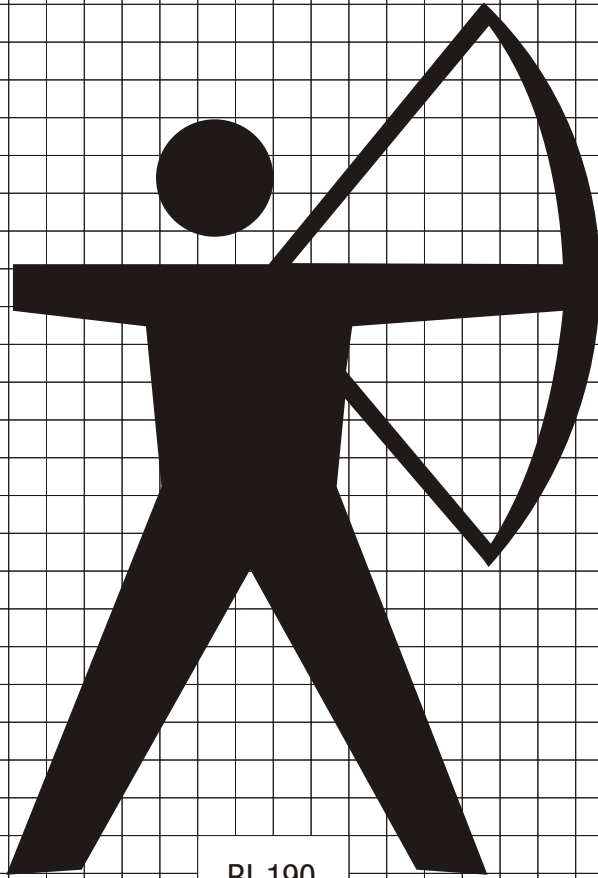

RL-190

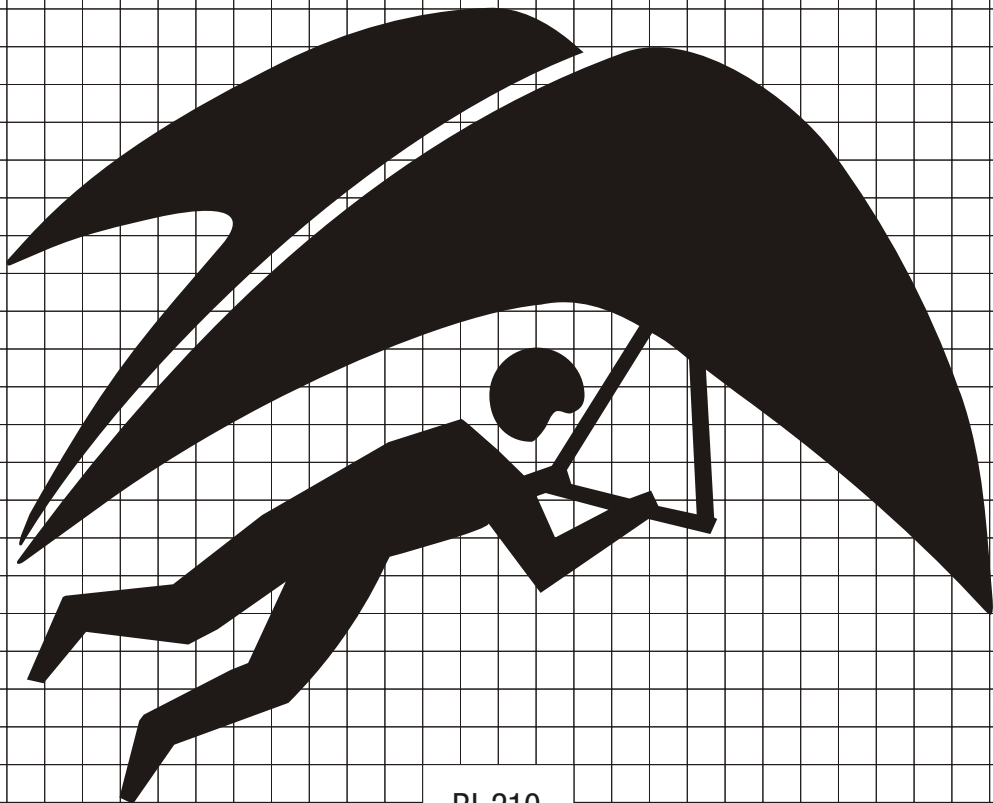

RL-210

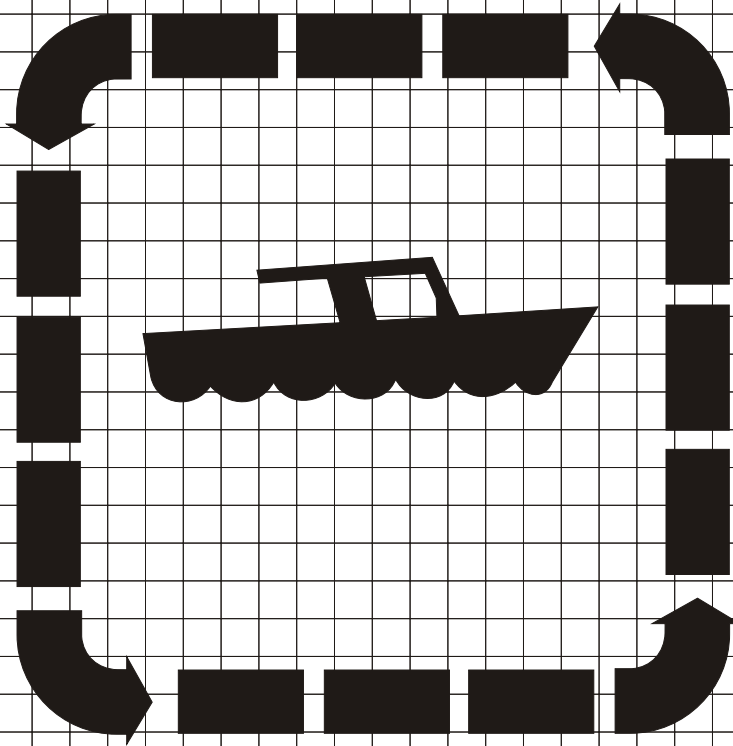

RW-010

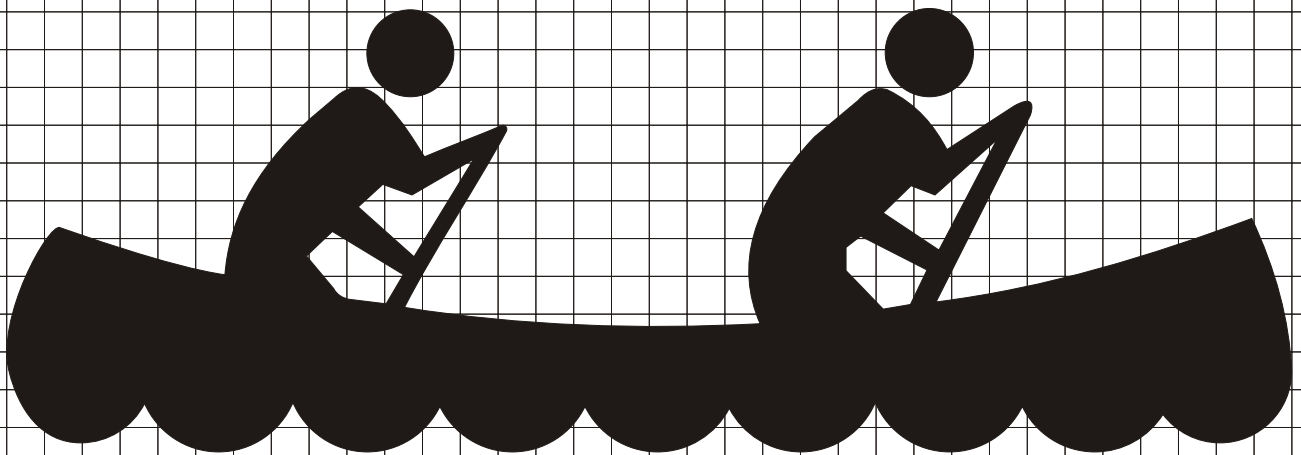

RW020

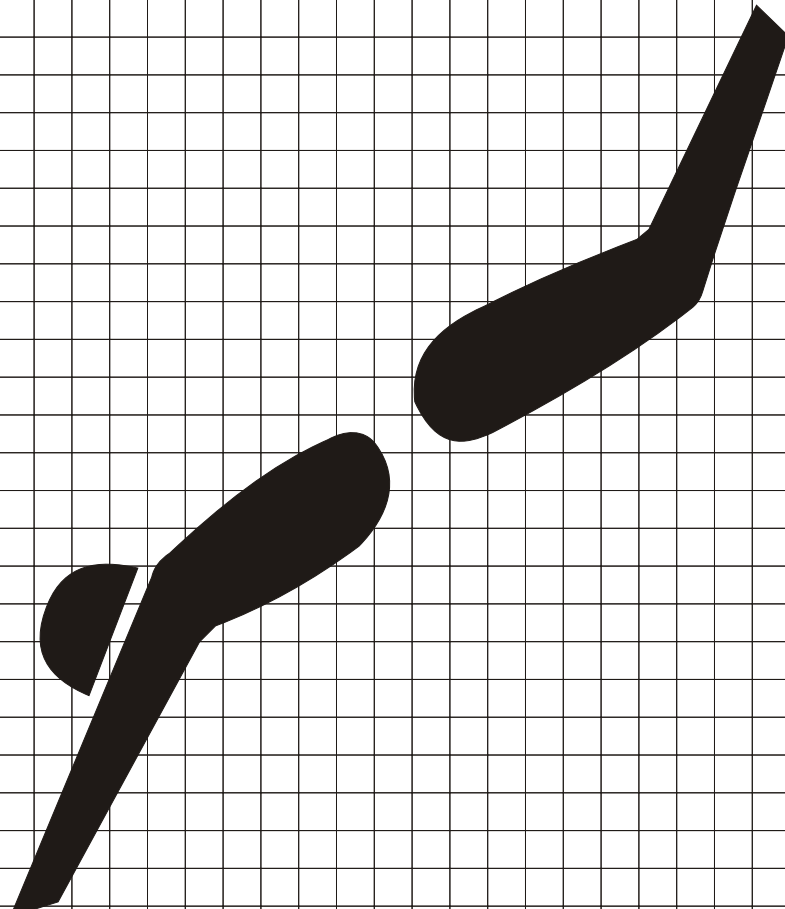

RW-030

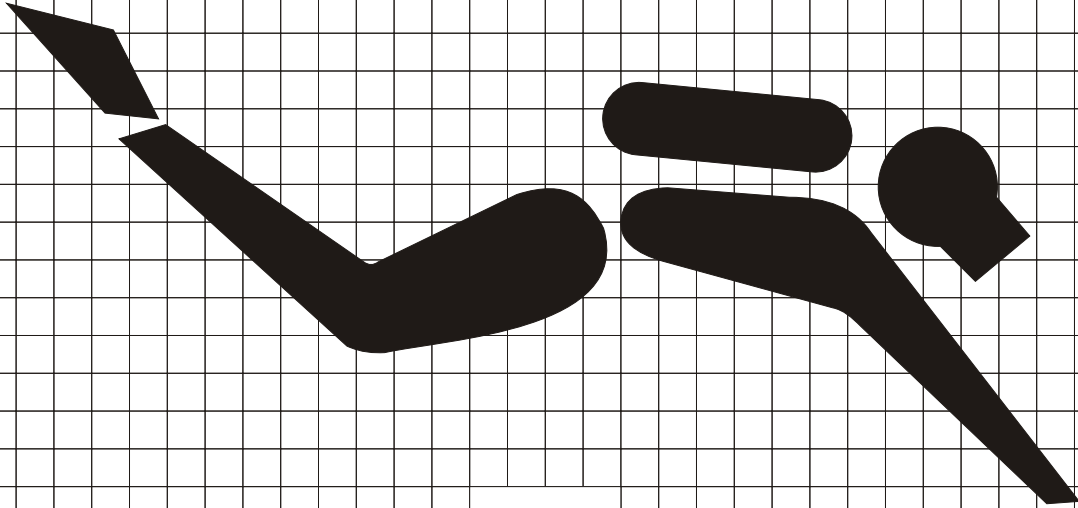

RW040

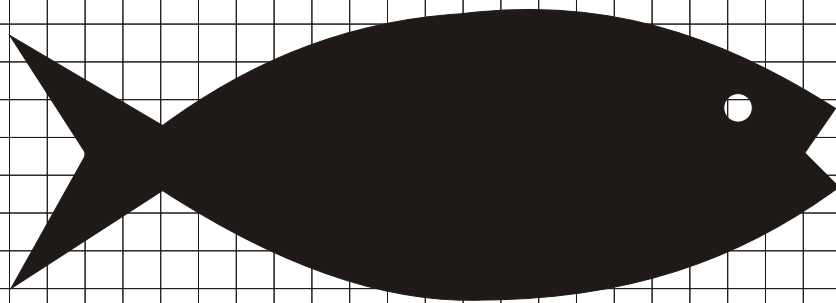

RW-050

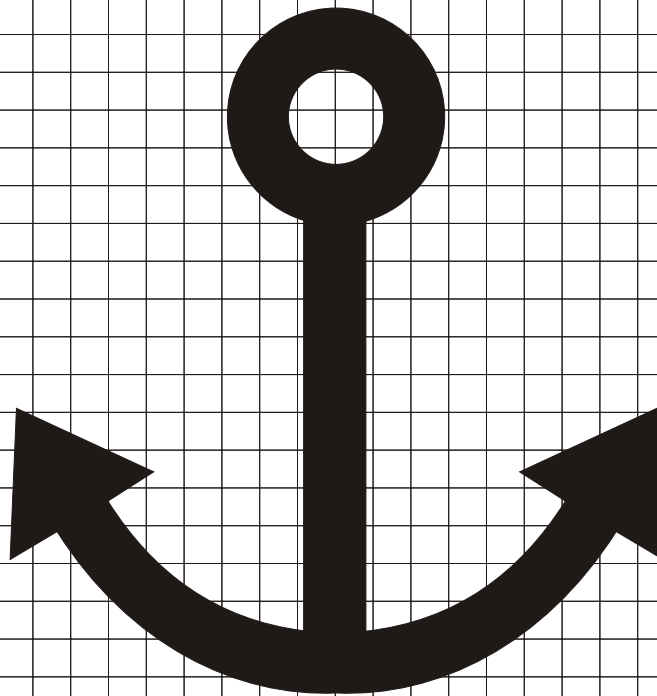

RW060

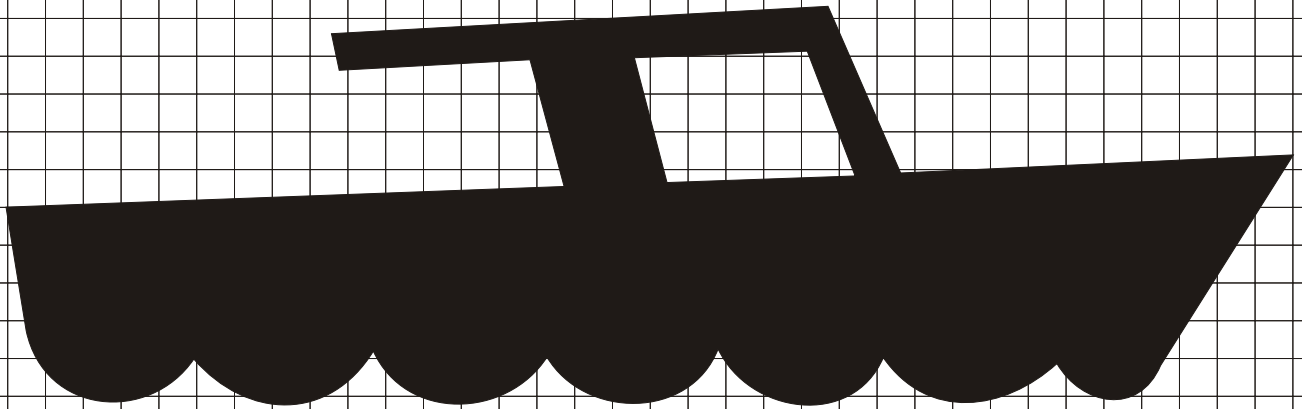

RW-070

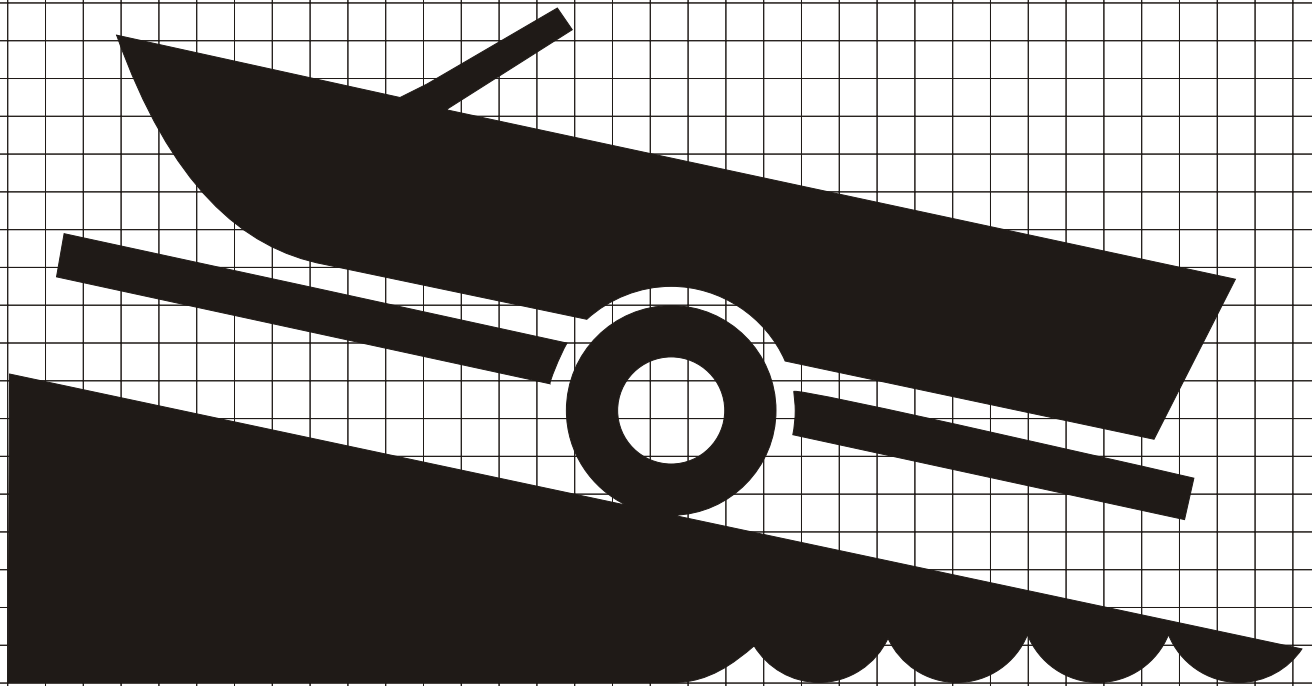

RW080

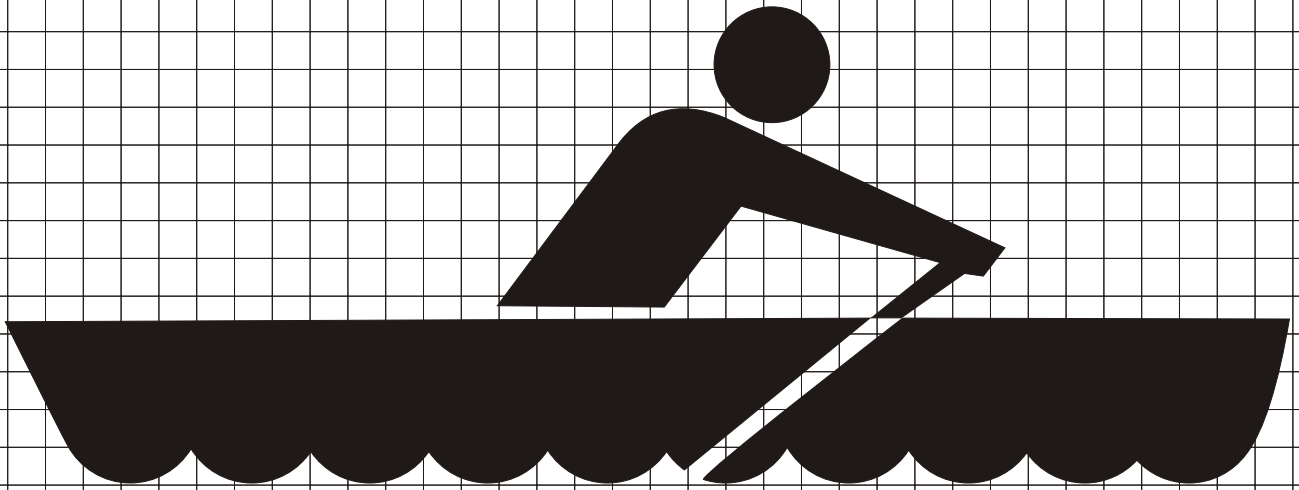

RW-090

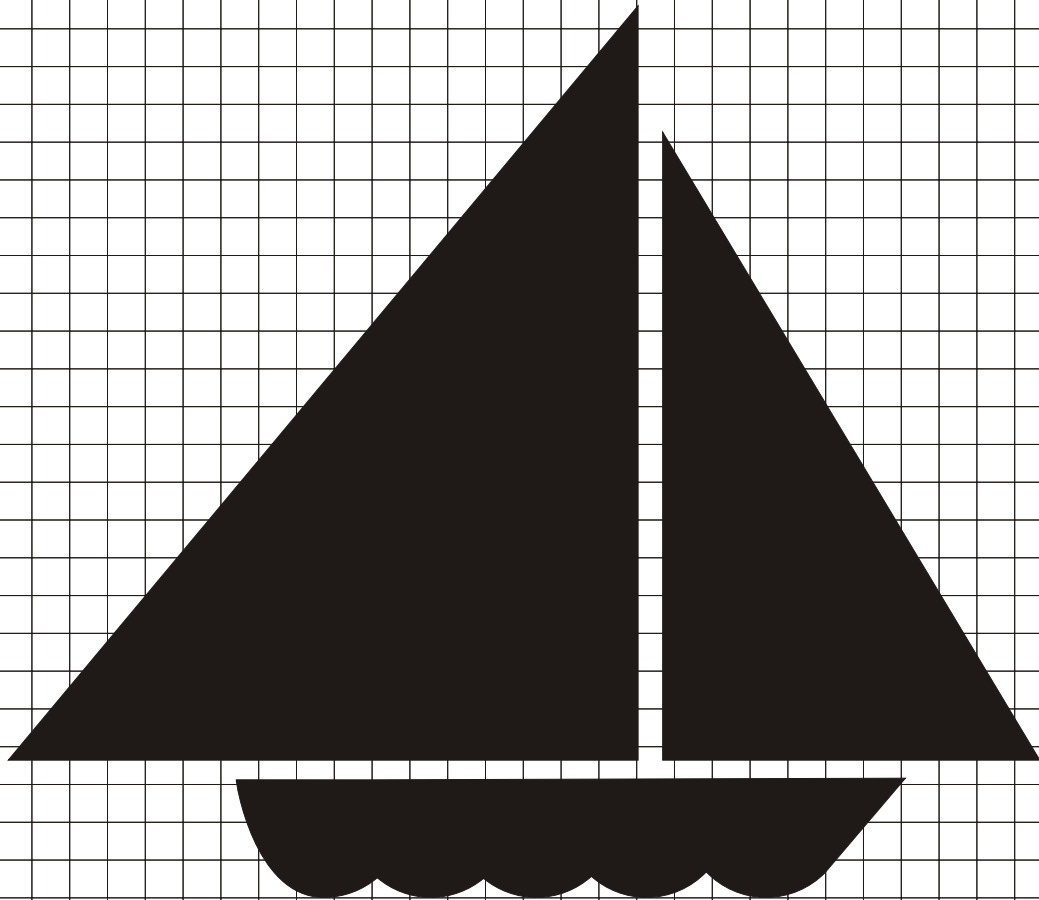

RW100

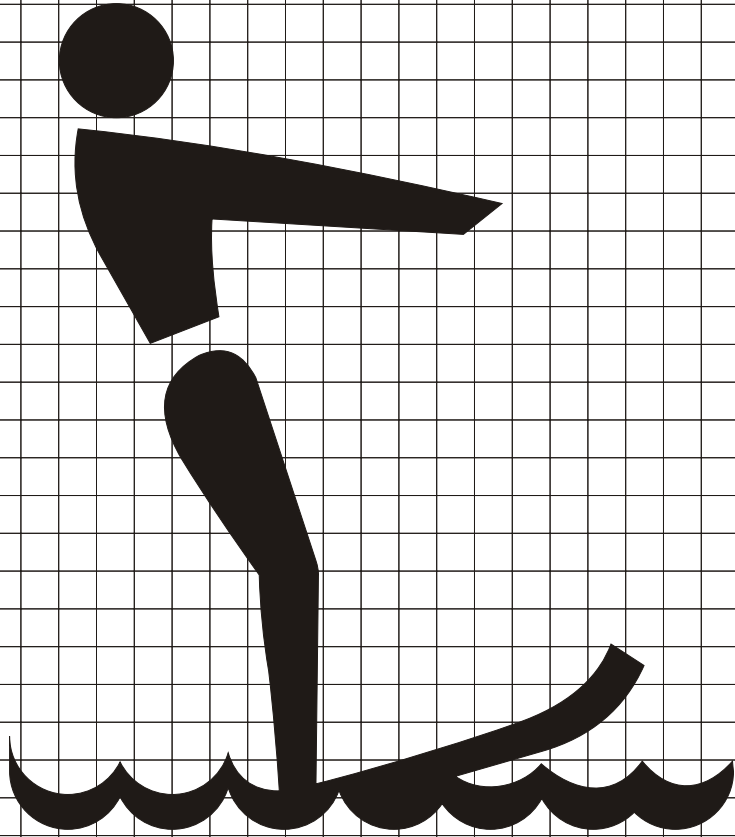

RW-110



RW120

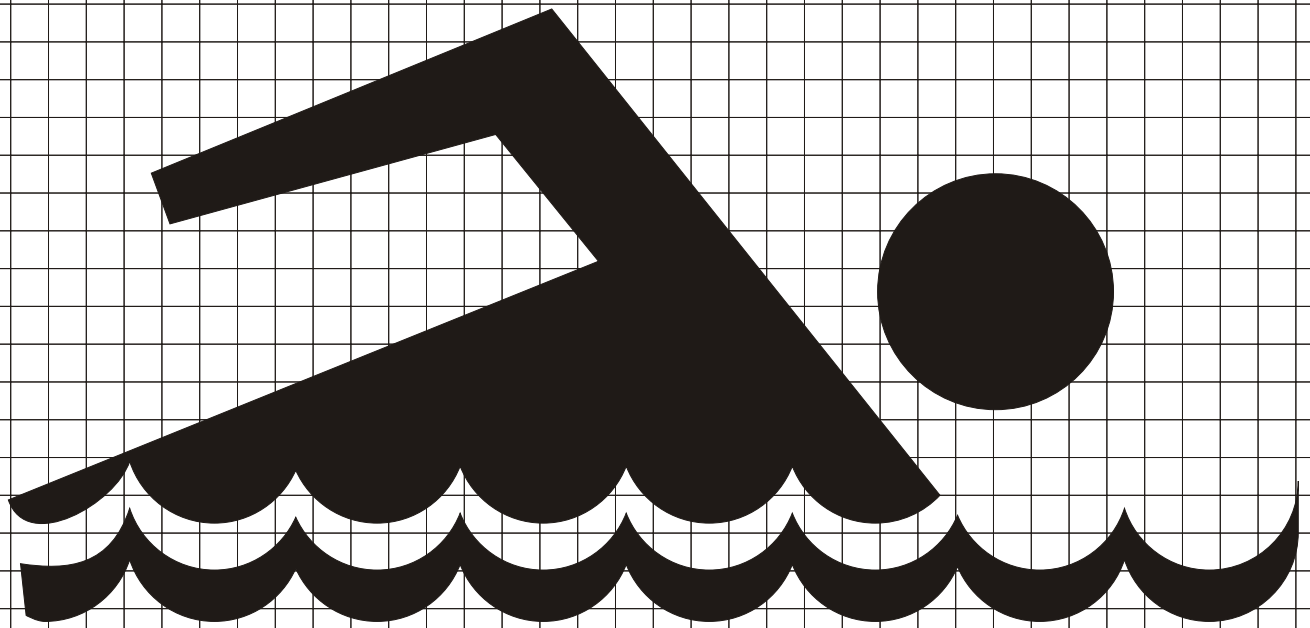

RW-130

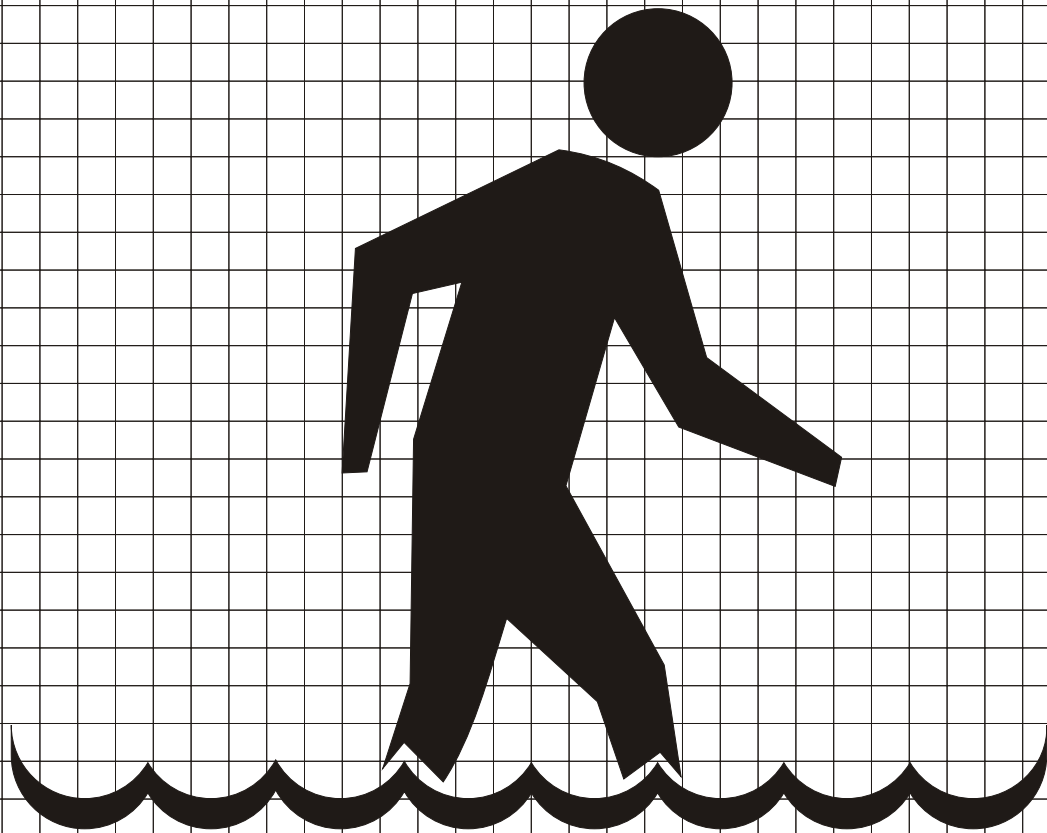

RW140

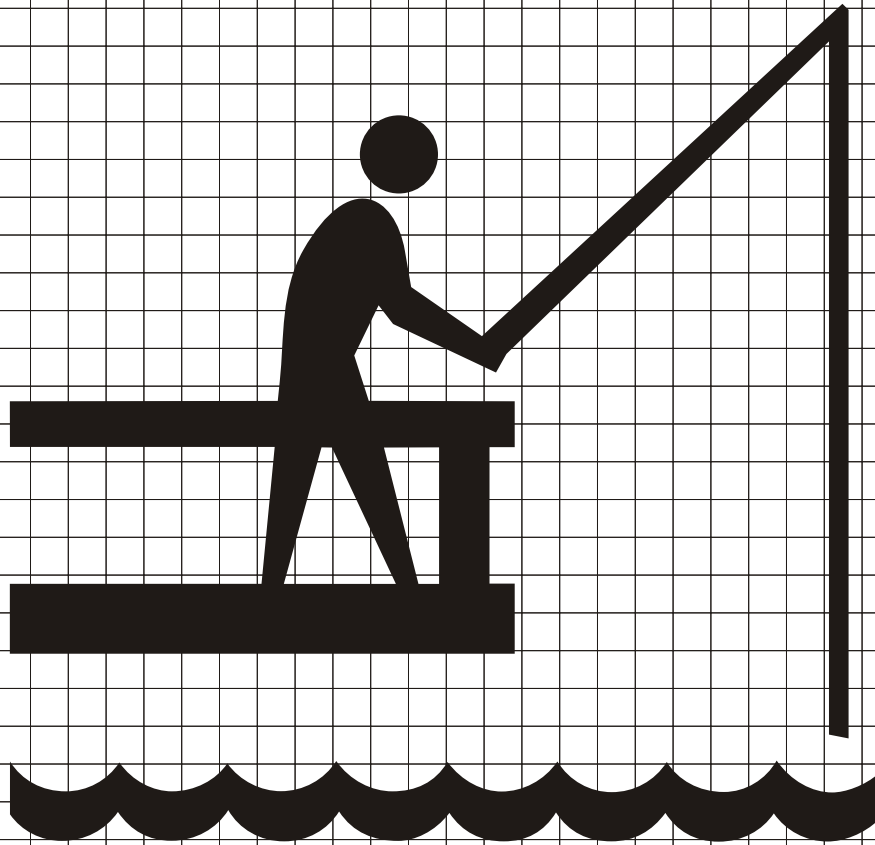

RW-160



RW170

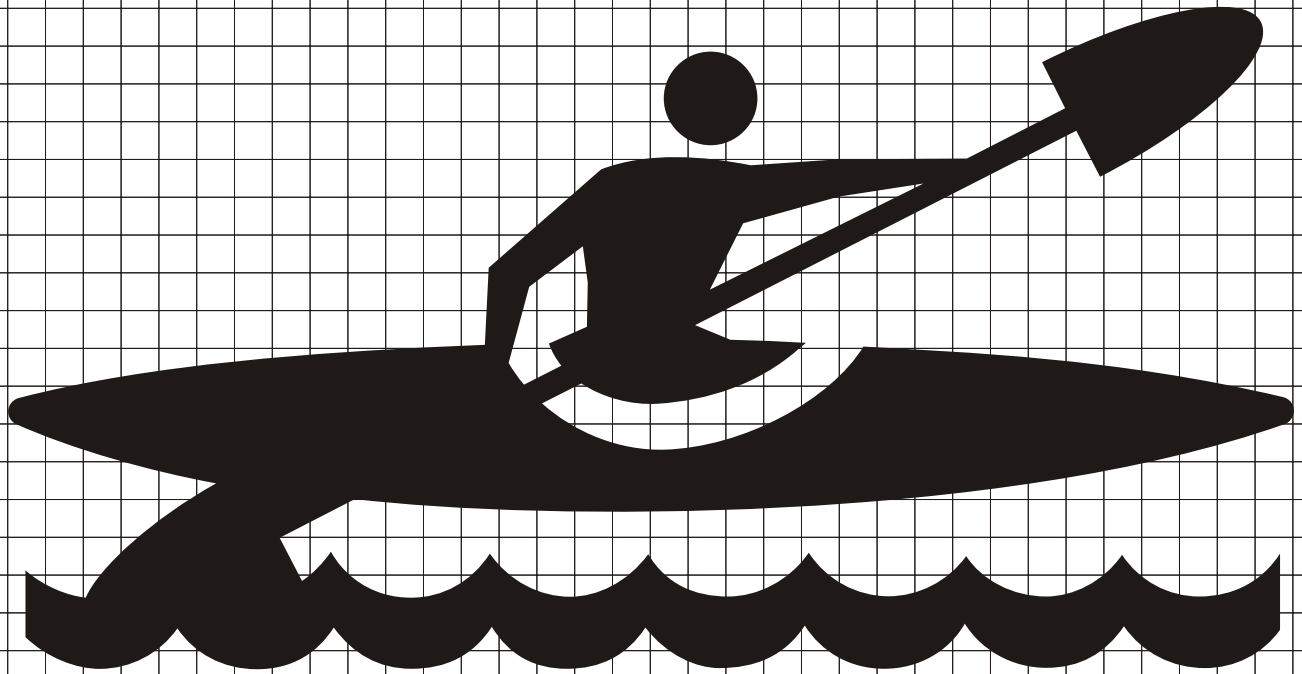

RW-190

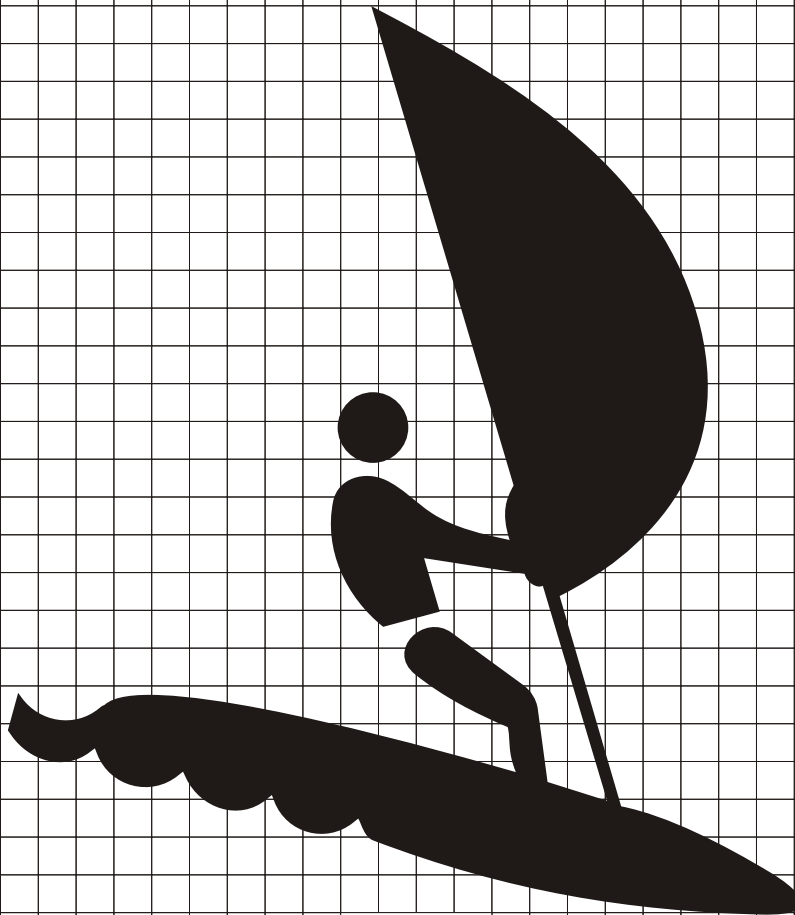

RW-210

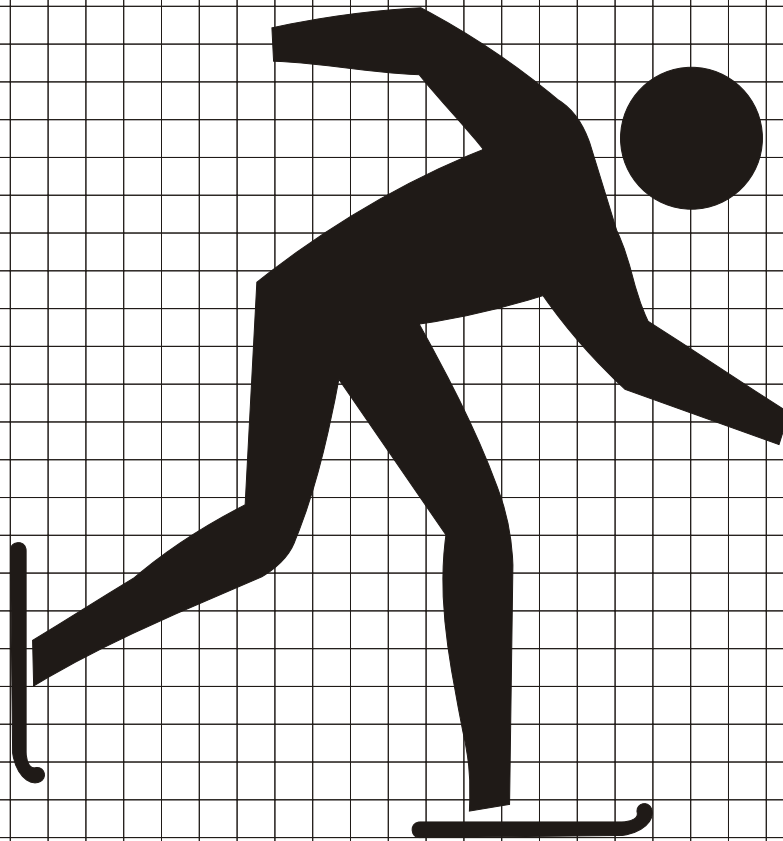

RS-010



RS-020



RS-030

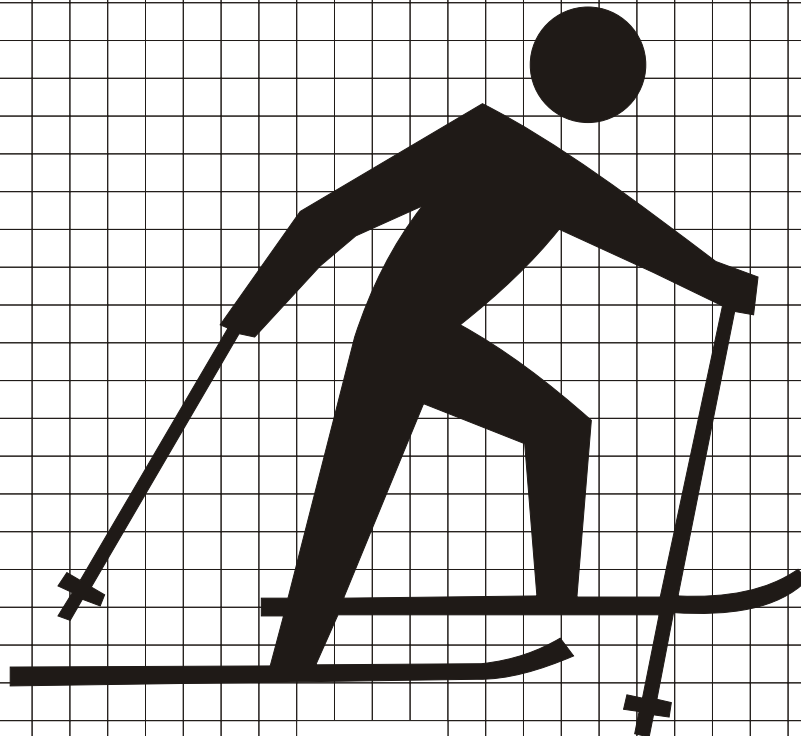

RS-040

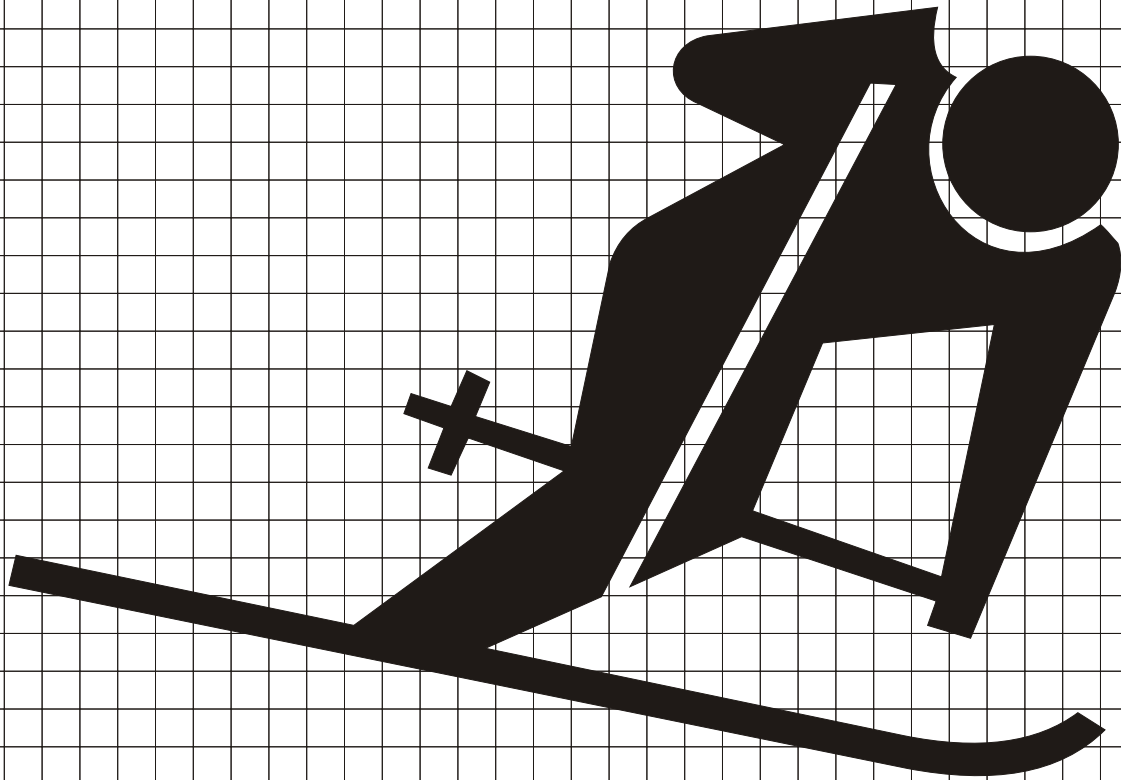

RS-050

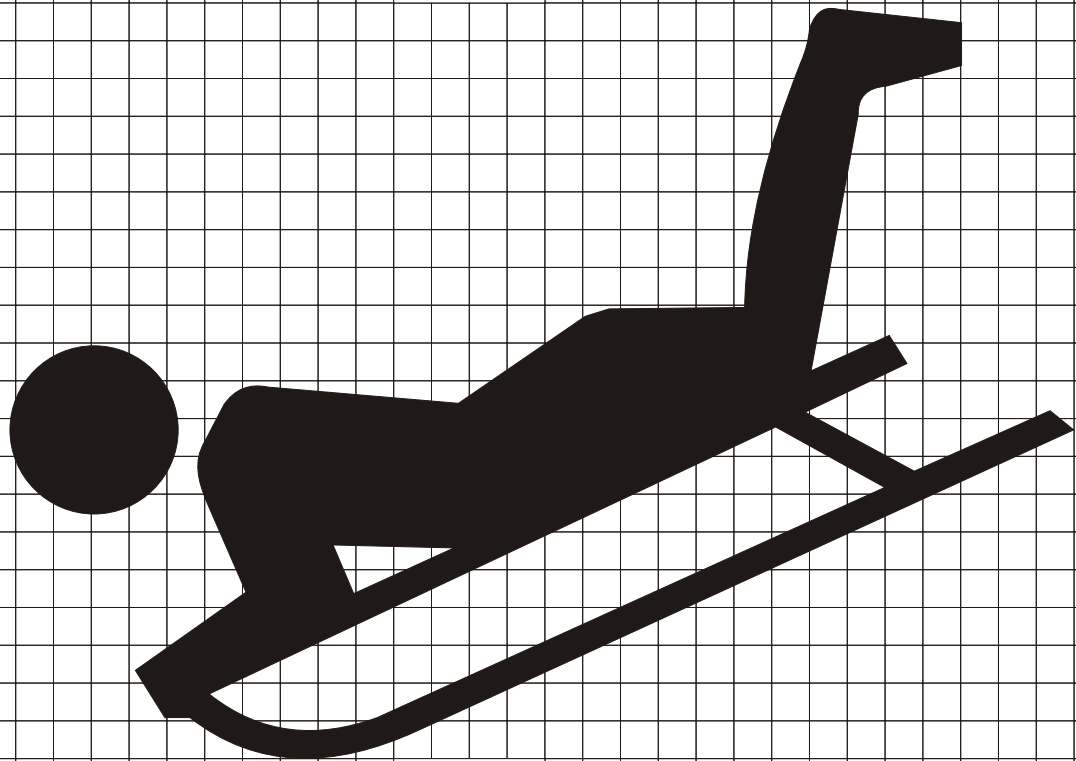

RS-060

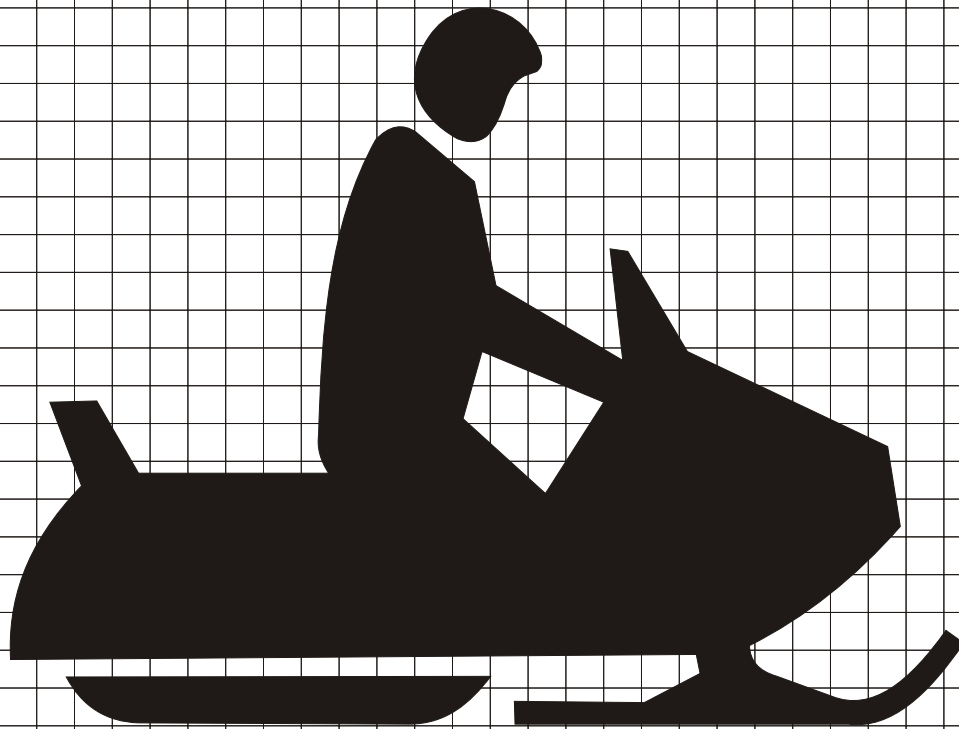

RS-070

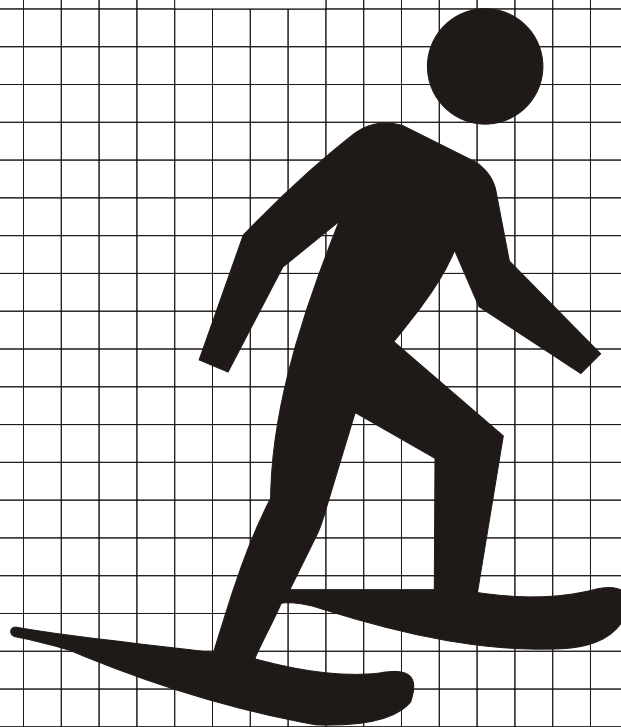

RS-080

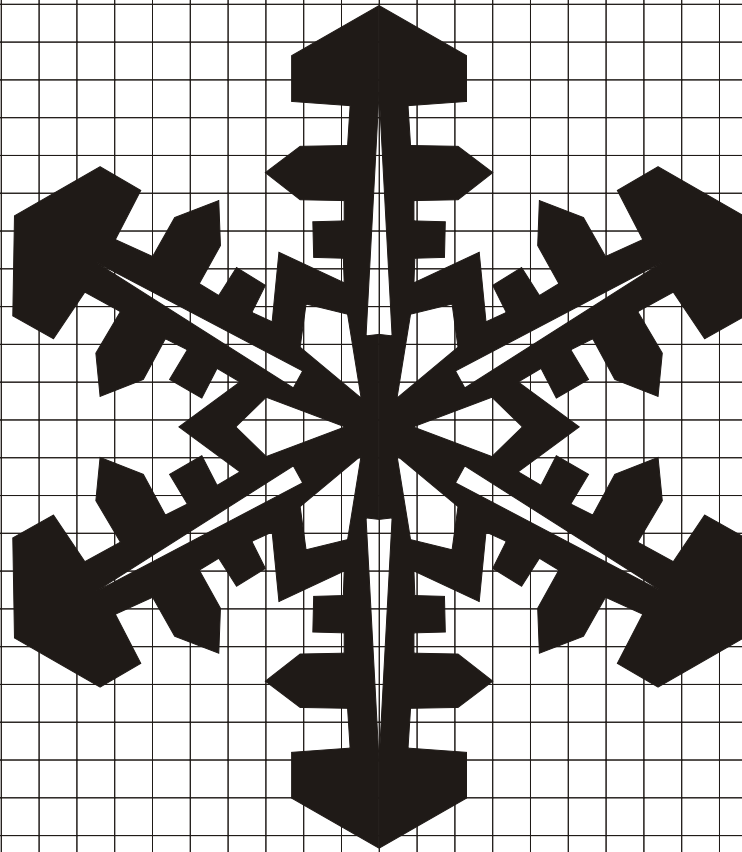

RS-090

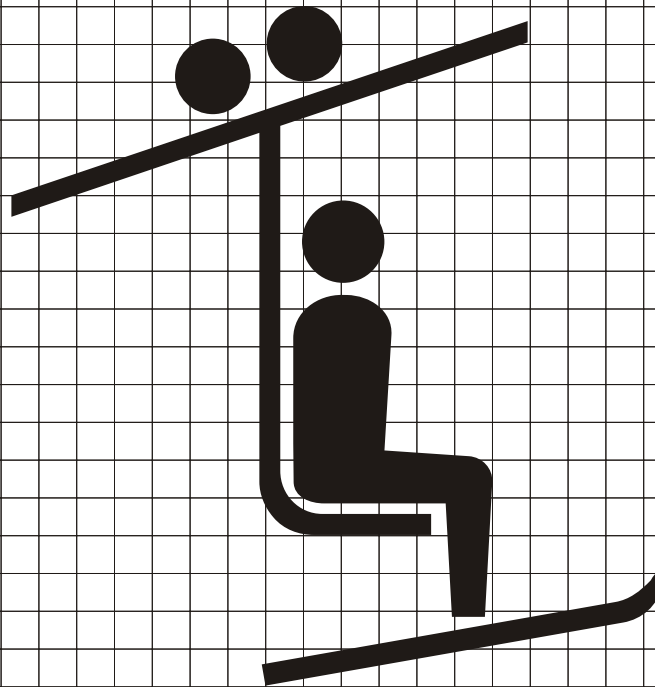

RS-100