

R1-2bP  
TO TRAFFIC IN CIRCLE (PLAQUE)

\* Reduce Spacing 20%.

A	B	C	D	E	F	G	H
24	15	0.375	0.5	3.25	3 C	2.5	3 C
36	24	0.375	0.625	5	5 C*	4	5 C

J	K	L	M	N	P	Q	R
3.662	2.25	3.467	9.378	2.761	3.122	8.132	1.5
5.983	2.625	5.975	14.583	4.601	5.765	12.991	1.5

COLORS: LEGEND, BORDER — BLACK  
BACKGROUND — WHITE (RETROREFLECTIVE)

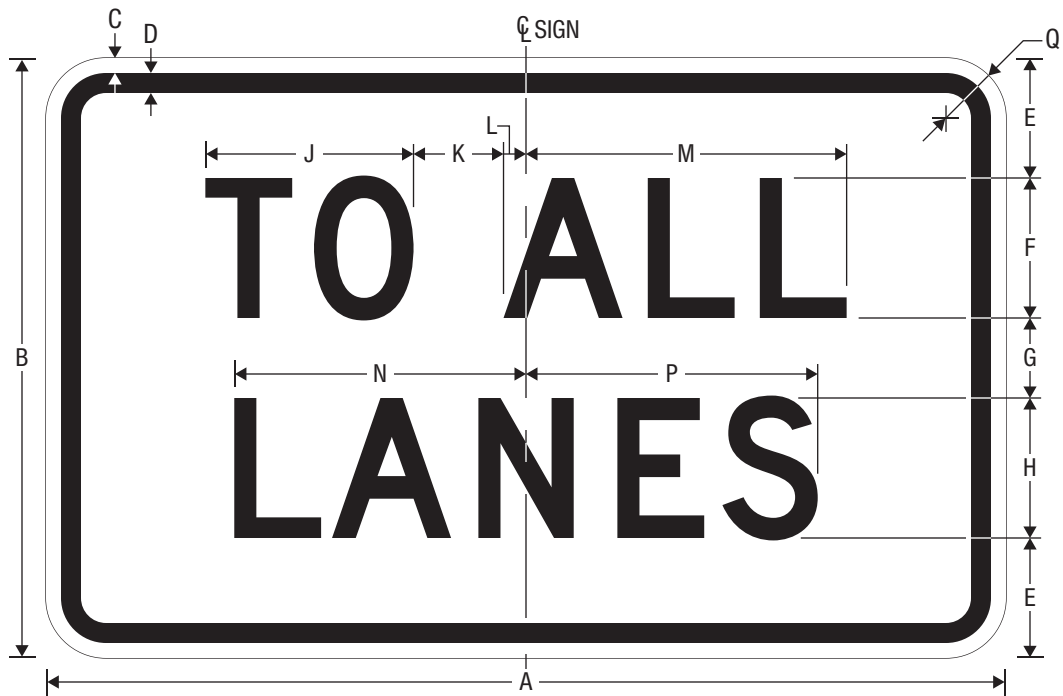

R1-2cP  
TO ALL LANES (PLAQUE)

\* Increase Spacing 20%.  
\*\* Increase Spacing 30%.

A	B	C	D	E	F	G	H
24	15	0.375	0.5	3	3.5 D*	2	3.5 D**
36	24	0.375	0.625	4.625	5.5 D*	3.75	5.5 D**

J	K	L	M	N	P	Q
5.204	2.25	0.562	8.016	7.293	7.293	1.5
8.177	3.5	0.896	12.585	11.461	11.460	1.5

COLORS: LEGEND, BORDER — BLACK  
BACKGROUND — WHITE (RETROREFLECTIVE)

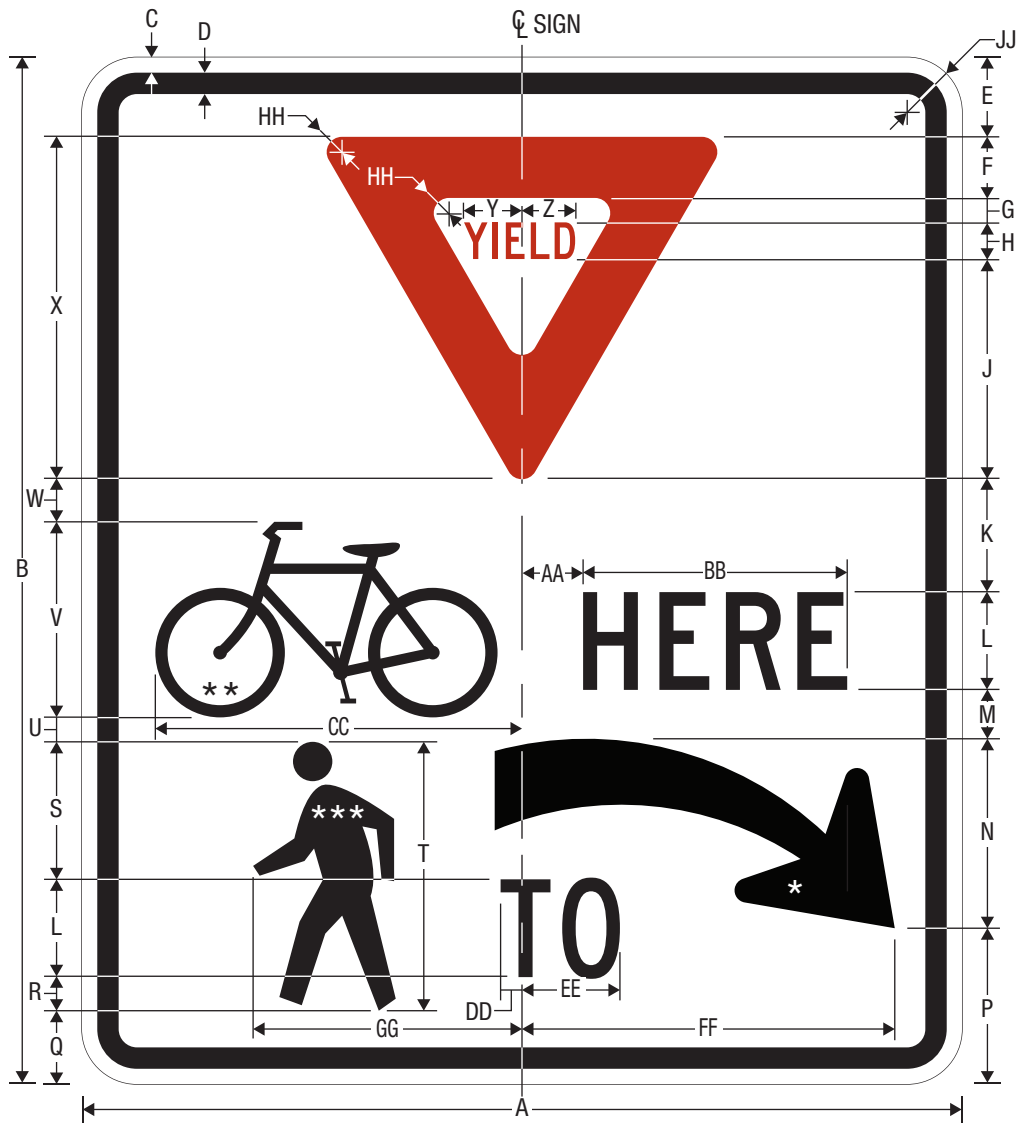

R1-5dR

YIELD HERE TO TRAIL CROSSING



R1-5dL

- \* See page 7-7 for detail.
- \*\* See page 8-4 for symbol design.
- \*\*\* See page 8-7 for symbol design.

A	B	C	D	E	F	G	H	J	K	L
36	42	0.625	0.875	3.25	2	1	1.5 C	9.5	4.625	4 C

M	N	P	Q	R	S	T	U	V	W	X
2	7.75	6.375	3	1.375	5.625	11	1	8	1.75	14

Y	Z	AA	BB	CC	DD	EE	FF	GG	HH	JJ
2.372	2.175	2.5	10.804	15	0.875	4.007	15.25	11	0.625	2.25

COLORS: LEGEND, BORDER — BLACK  
 BACKGROUND, YIELD SIGN INNER BACKGROUND — WHITE (RETROREFLECTIVE)  
 YIELD SIGN LEGEND AND OUTER BACKGROUND — RED (RETROREFLECTIVE)



R1-5eR

STOP HERE FOR TRAIL CROSSING



R1-5eL

\* See page 7-7 for detail.

\*\* See page 8-4 for symbol design.

\*\*\* See page 8-7 for symbol design.

A	B	C	D	E	F	G	H	J	K
36	42	0.625	0.875	3	4.25	4.5 C	5.875	4 C	2

L	M	N	P	Q	R	S	T	U	V
7.75	6.375	3	1.375	5.625	11	1	8	3	13

W	X	Y	Z	AA	BB	CC	DD	EE	FF
5.385	5.920	15	2.5	10.804	0.875	7.048	15.25	11	2.25

COLORS: LEGEND, BORDER — BLACK (RETROREFLECTIVE)  
 BACKGROUND, STOP SIGN LEGEND — WHITE (RETROREFLECTIVE)  
 STOP SIGN BACKGROUND — RED (RETROREFLECTIVE)

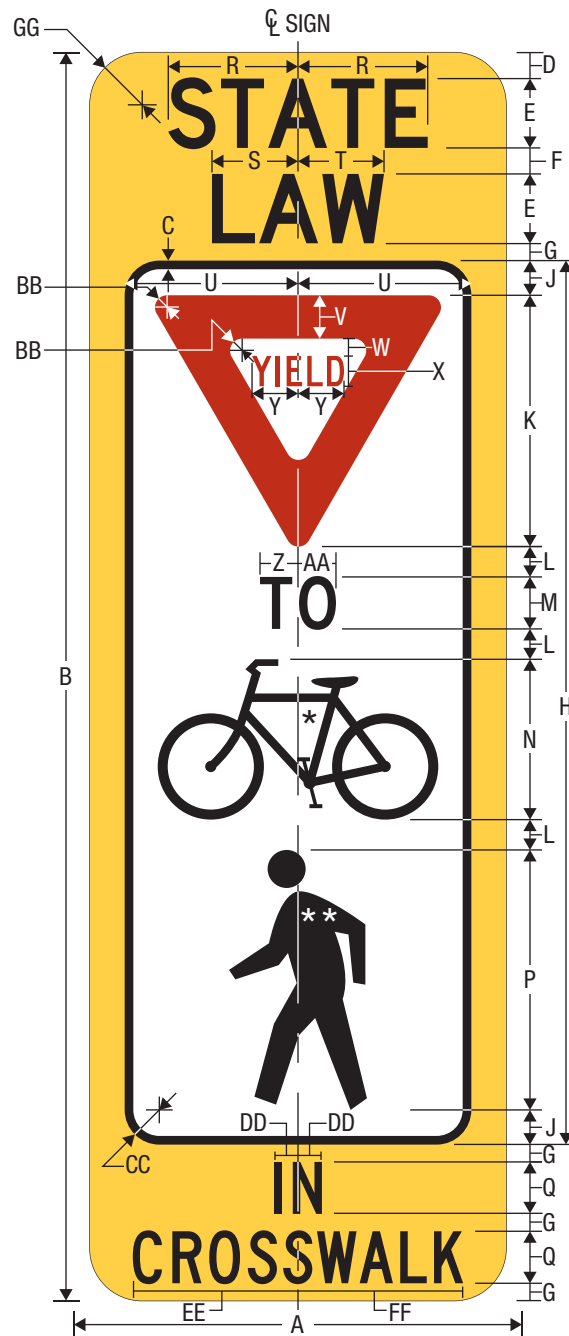

R1-6d  
IN-STREET TRAIL CROSSING - YIELD

\* See page 8-4 for symbol design.  
\*\* See page 8-7 for symbol design.

A	B	C	D	E	F	G	H	J	K	L	M	N	P	Q	R
12	36	0.25	0.75	2 D	0.75	0.5	25.5	1	7.25	0.875	1.5 D	4.625	7.5	1.5 C	3.742

S	T	U	V	W	X	Y	Z	AA	BB	CC	DD	EE	FF	GG
2.482	2.481	5	1.25	0.5	0.875 C	1.326	1.096	1.095	0.350	1	0.690	4.765	4.764	1.5

- COLORS:
- LEGEND, INNER BORDER — BLACK
  - INNER BACKGROUND — WHITE (RETROREFLECTIVE)
  - OUTER BACKGROUND — YELLOW or FLUORESCENT YELLOW-GREEN (RETROREFLECTIVE)
  - YIELD SIGN LEGEND AND OUTER BACKGROUND — RED (RETROREFLECTIVE)

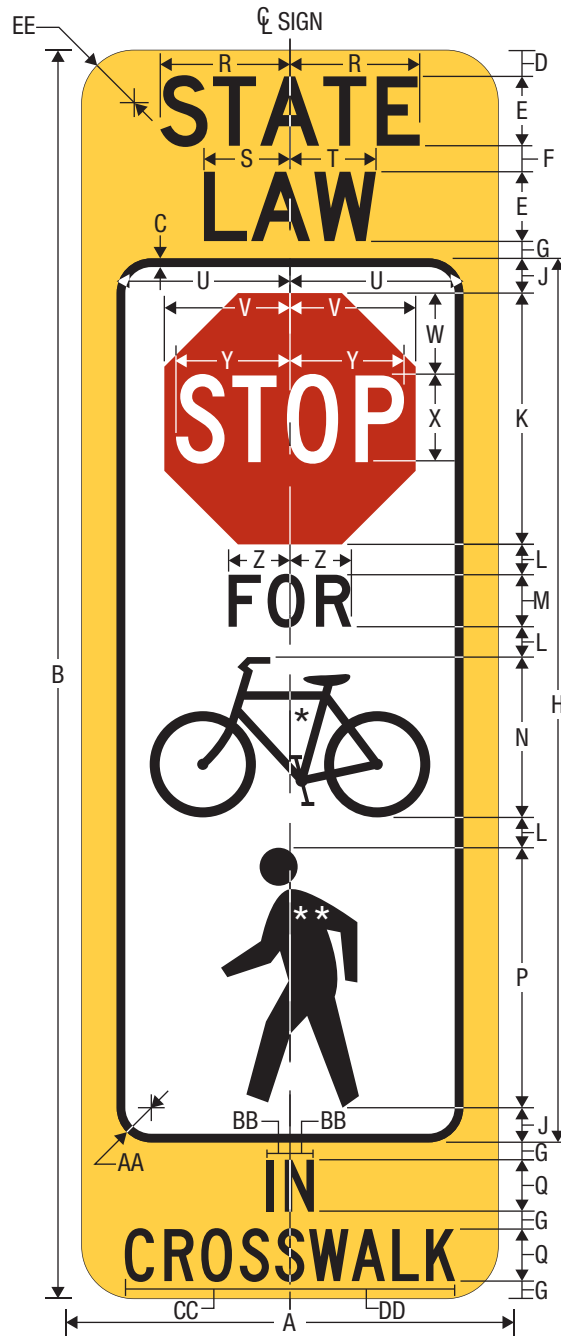

R1-6e  
IN-STREET TRAIL CROSSING - STOP

\* See page 8-4 for symbol design.  
\*\* See page 8-7 for symbol design.

A	B	C	D	E	F	G	H	J	K	L	M	N	P	Q
12	36	0.25	0.75	2 D	0.75	0.5	25.5	1	7.25	0.875	1.5 D	4.625	7.5	1.5 C

R	S	T	U	V	W	X	Y	Z	AA	BB	CC	DD	EE
3.742	2.482	2.481	5	3.625	2.375	2.5 C	3.289	1.771	1	0.690	4.765	4.764	1.5

- COLORS: LEGEND, INNER BORDER — BLACK  
 INNER BACKGROUND, STOP SIGN LEGEND — WHITE (RETROREFLECTIVE)  
 OUTER BACKGROUND — YELLOW or FLUORESCENT YELLOW-GREEN (RETROREFLECTIVE)  
 STOP SIGN BACKGROUND — RED (RETROREFLECTIVE)

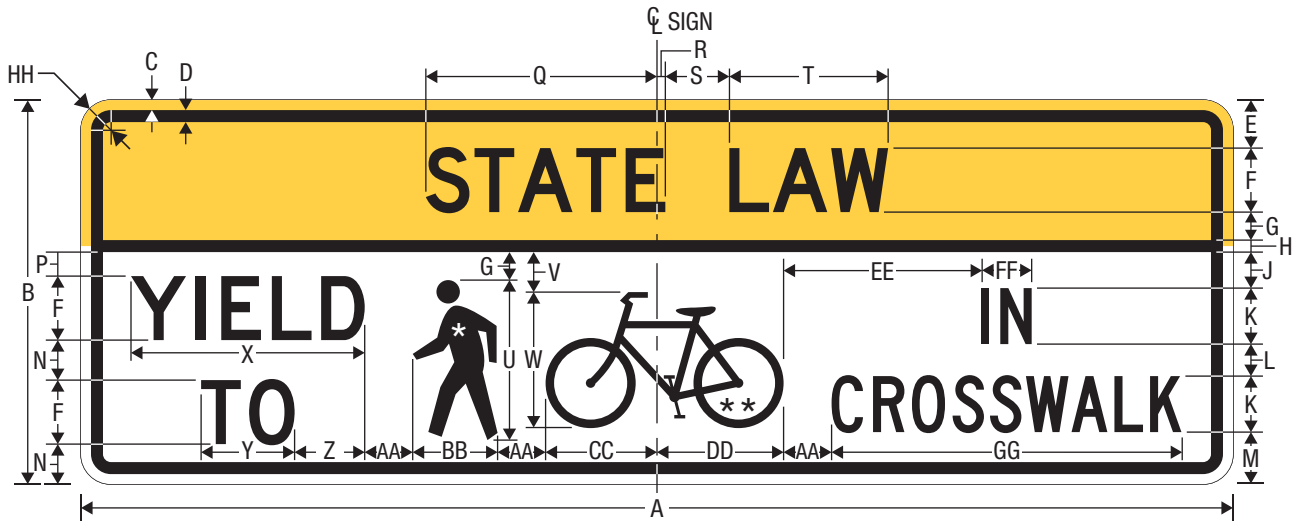

R1-9d  
OVERHEAD TRAIL CROSSING - YIELD

- \* See page 8-7 for symbol design.
- \*\* See page 8-4 for symbol design.
- \*\*\* Reduce Spacing 10%.

A	B	C	D	E	F	G	H	J	K	L
72	24	0.625	0.75	3	4 D	1.75	0.75	2.25	3.5 C***	2

M	N	P	Q	R	S	T	U	V	W	X
3.25	2.5	1.5	14.447	0.521	4	9.925	10	2.5	8.5	14.607

Y	Z	AA	BB	CC	DD	EE	FF	GG	HH
5.843	4.382	3	5.305	6.963	7.912	12.361	3.144	21.866	1.875

COLORS: LEGEND, BORDER — BLACK  
 UPPER BACKGROUND — YELLOW (RETROREFLECTIVE) OR FLUORESCENT YELLOW-GREEN (RETROREFLECTIVE)  
 LOWER BACKGROUND — WHITE (RETROREFLECTIVE)

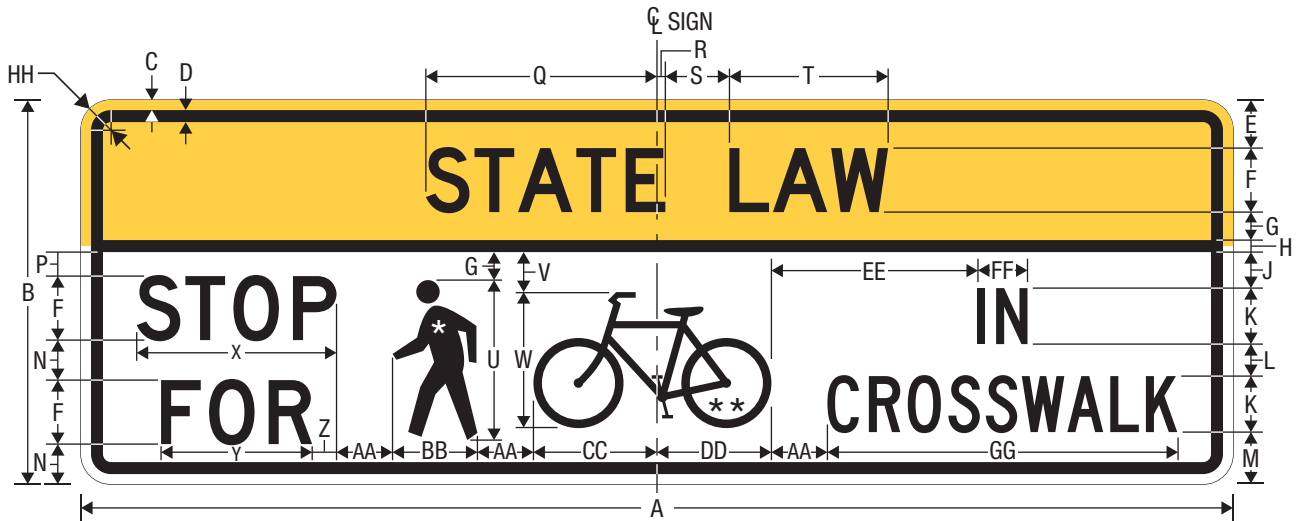

R1-9e  
OVERHEAD TRAIL CROSSING - STOP

- \* See page 8-7 for symbol design.
- \*\* See page 8-4 for symbol design.
- \*\*\* Reduce Spacing 10%.

A	B	C	D	E	F	G	H	J	K	L
72	24	0.625	0.75	3	4 D	1.75	0.75	2.25	3.5 C***	2

M	N	P	Q	R	S	T	U	V	W	X
3.25	2.5	1.5	14.447	0.521	4	9.925	10	2.5	8.5	12.489

Y	Z	AA	BB	CC	DD	EE	FF	GG	HH
9.446	1.521	3.5	5.305	7.724	7.151	12.861	3.144	21.866	1.875

COLORS: LEGEND, BORDER — BLACK  
 UPPER BACKGROUND — YELLOW (RETROREFLECTIVE) OR FLUORESCENT YELLOW-GREEN (RETROREFLECTIVE)  
 LOWER BACKGROUND — WHITE (RETROREFLECTIVE)





R2-2aP  
BUS SPEED LIMIT (PLAQUE)

\* Optically space numerals about vertical centerline.

A	B	C	D	E	F	G	H	J	K	L	M
24	0.375	0.625	4	4 D	2.5	10 E	3.5	7.907	7.906	VAR*	1.5
36	0.625	0.875	6	6 D	5	13 E	6	11.860	11.860	VAR*	2.25
48	0.75	1.25	8	8 D	8	16 E	8	15.813	15.813	VAR*	3

COLORS: LEGEND, BORDER — BLACK  
BACKGROUND — WHITE (RETROREFLECTIVE)

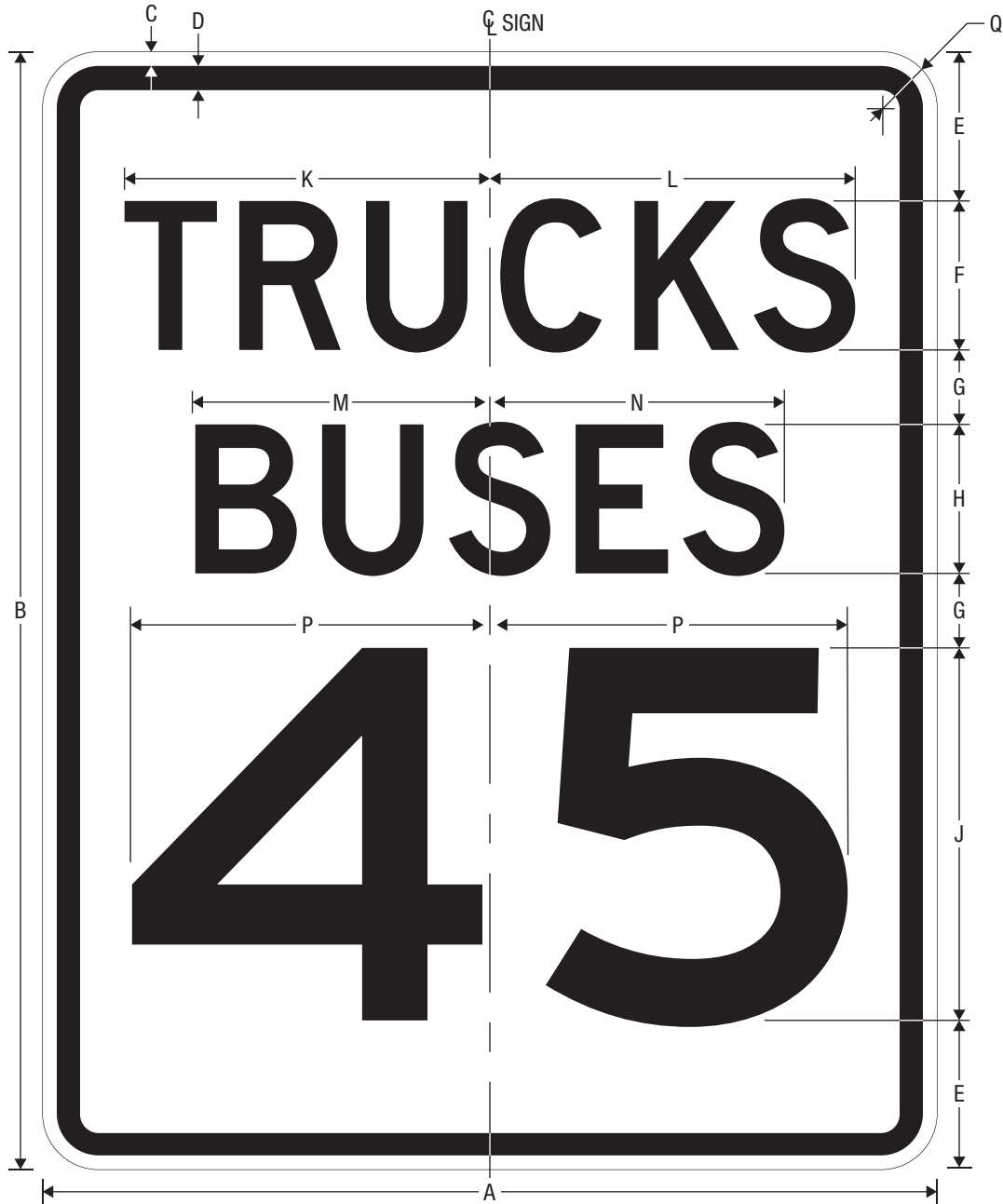

R2-2bP

TRUCK-BUS SPEED LIMIT (PLAQUE)

\* Reduce Spacing 30%.

\*\* Optically space numerals about centerline.

A	B	C	D	E	F	G	H	J	K	L	M	N	P	Q
24	30	0.375	0.625	4	4 D	2	4 D	10 E	9.808	9.807	7.907	7.906	VAR**	1.5
36	42	0.625	0.875	4.5	6 D*	3.5	6 D	14 E	13.938	13.937	11.860	11.860	VAR**	2.25
48	54	0.75	1.25	6.5	8 D*	4.5	8 D	16 E	18.583	18.583	15.813	15.813	VAR**	3

COLORS: LEGEND, BORDER — BLACK  
BACKGROUND — WHITE (RETROREFLECTIVE)

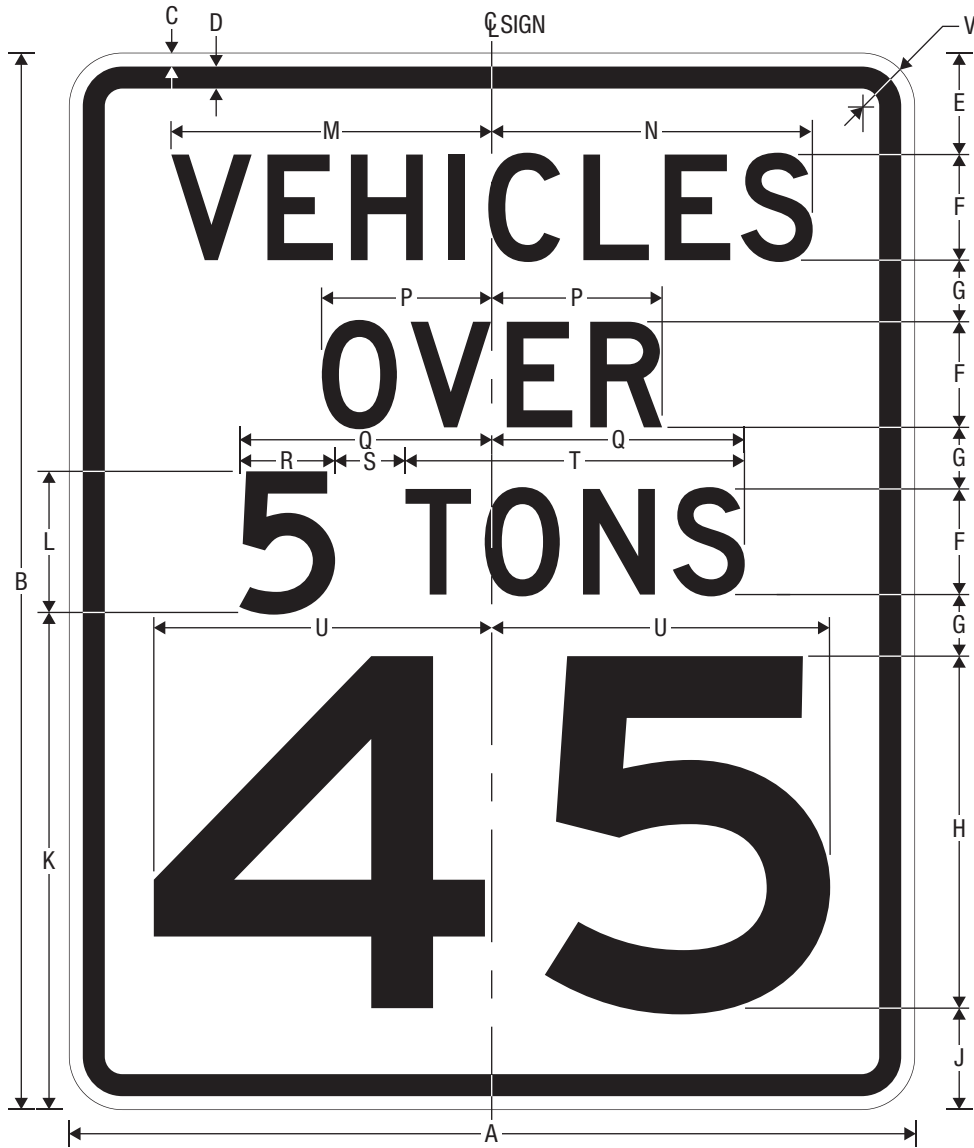

R2-2cP

VEHICLES OVER X TONS SPEED LIMIT (PLAQUE)

\* Increase Spacing 25%.

\*\* Optically space numerals about vertical centerline.

A	B	C	D	E	F	G	H	J	K
24	30	0.375	0.625	2.875	3 D	1.75	10 E	2.875	14.125
36	42	0.625	0.875	3.75	4 D*	3.5	12 E	3.75	18.75
48	54	0.75	1.25	5	5.5 D*	3.875	16 E	4.875	24

L	M	N	P	Q	R	S	T	U	V
4 D	9.111	9.110	4.833	VAR	VAR	2	9.637	VAR**	1.5
5 D*	12.772	12.772	6.669	VAR	VAR	3	13.369	VAR**	2.25
7 D*	17.562	17.561	9.170	VAR	VAR	5	18.382	VAR**	3

COLORS: LEGEND, BORDER – BLACK  
BACKGROUND – WHITE (RETROREFLECTIVE)

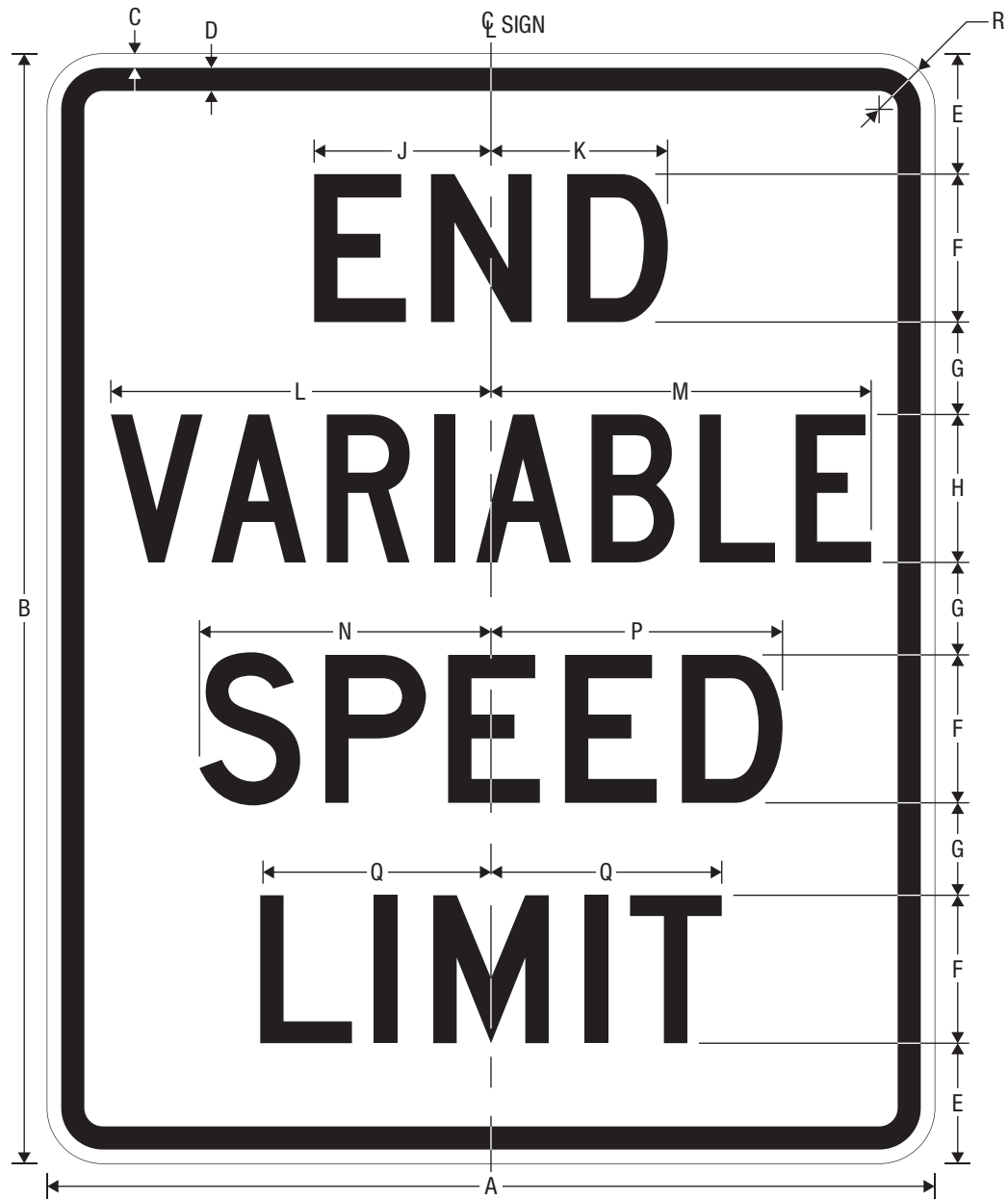

R2-13

END VARIABLE SPEED LIMIT

A	B	C	D	E	F	G	H
24	30	0.375	0.625	3.25	4 D	2.5	4 C
36	48	0.625	0.875	5.25	6 D	4.5	6 C
48	60	0.75	1.25	6.5	8 D	5	8 C

J	K	L	M	N	P	Q	R
4.784	4.783	10.284	10.283	7.886	7.885	6.242	1.5
7.176	7.175	15.425	15.425	11.828	11.828	9.363	2.25
9.567	9.567	20.567	20.567	15.771	15.771	12.484	3

COLORS: LEGEND, BORDER – BLACK  
BACKGROUND – WHITE (RETROREFLECTIVE)

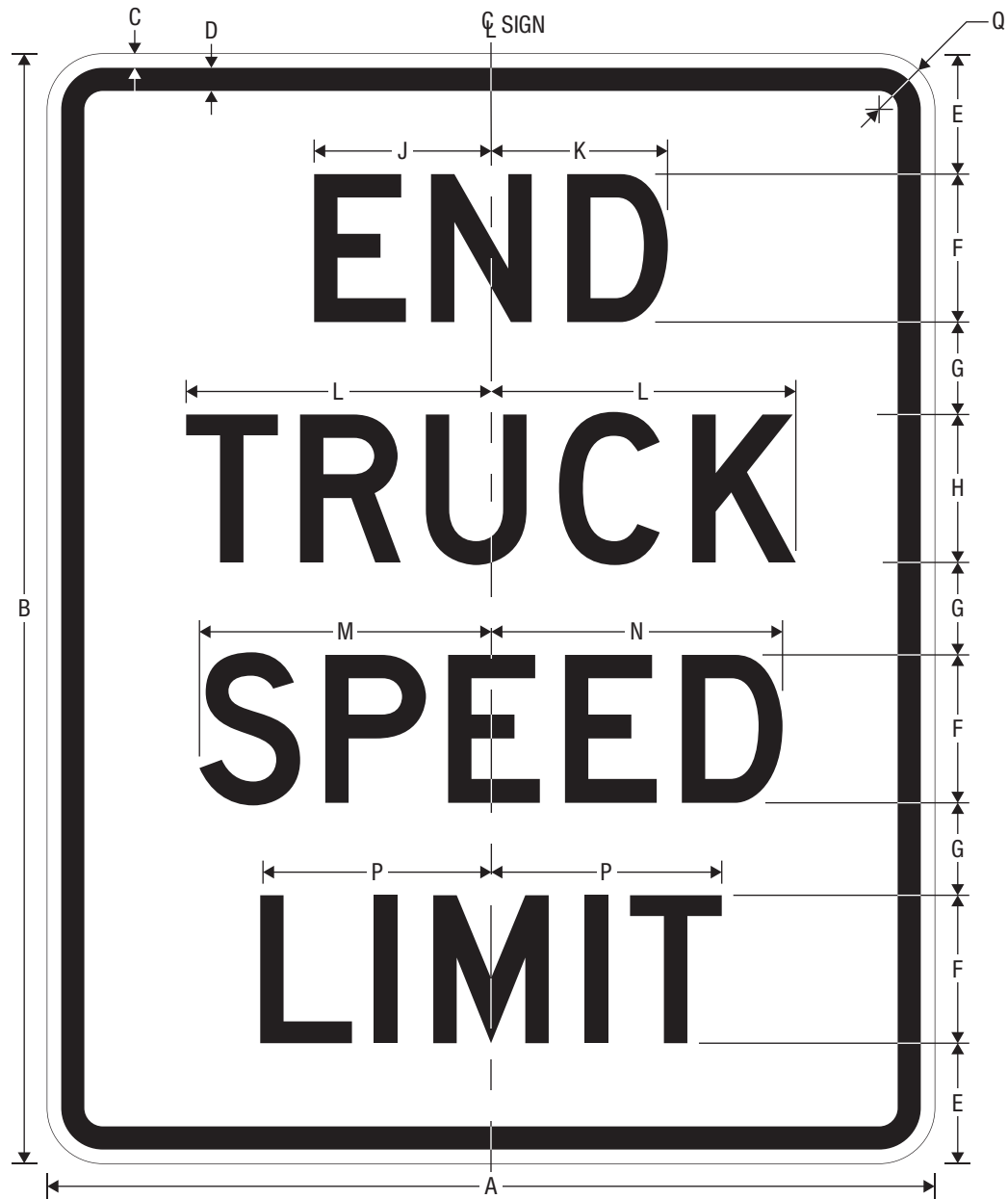

R2-14  
END TRUCK SPEED LIMIT

A	B	C	D	E	F	G	H
24	30	0.375	0.625	3.25	4 D	2.5	4 D
36	48	0.625	0.875	5.25	6 D	4.5	6 D
48	60	0.75	1.25	6.5	8 D	5	8 D

J	K	L	M	N	P	Q
4.784	4.783	8.246	7.886	7.885	6.242	1.5
7.176	7.175	12.369	11.829	11.828	9.363	2.25
9.567	9.567	16.492	15.771	15.771	12.484	3

COLORS: LEGEND, BORDER – BLACK  
BACKGROUND – WHITE (RETROREFLECTIVE)

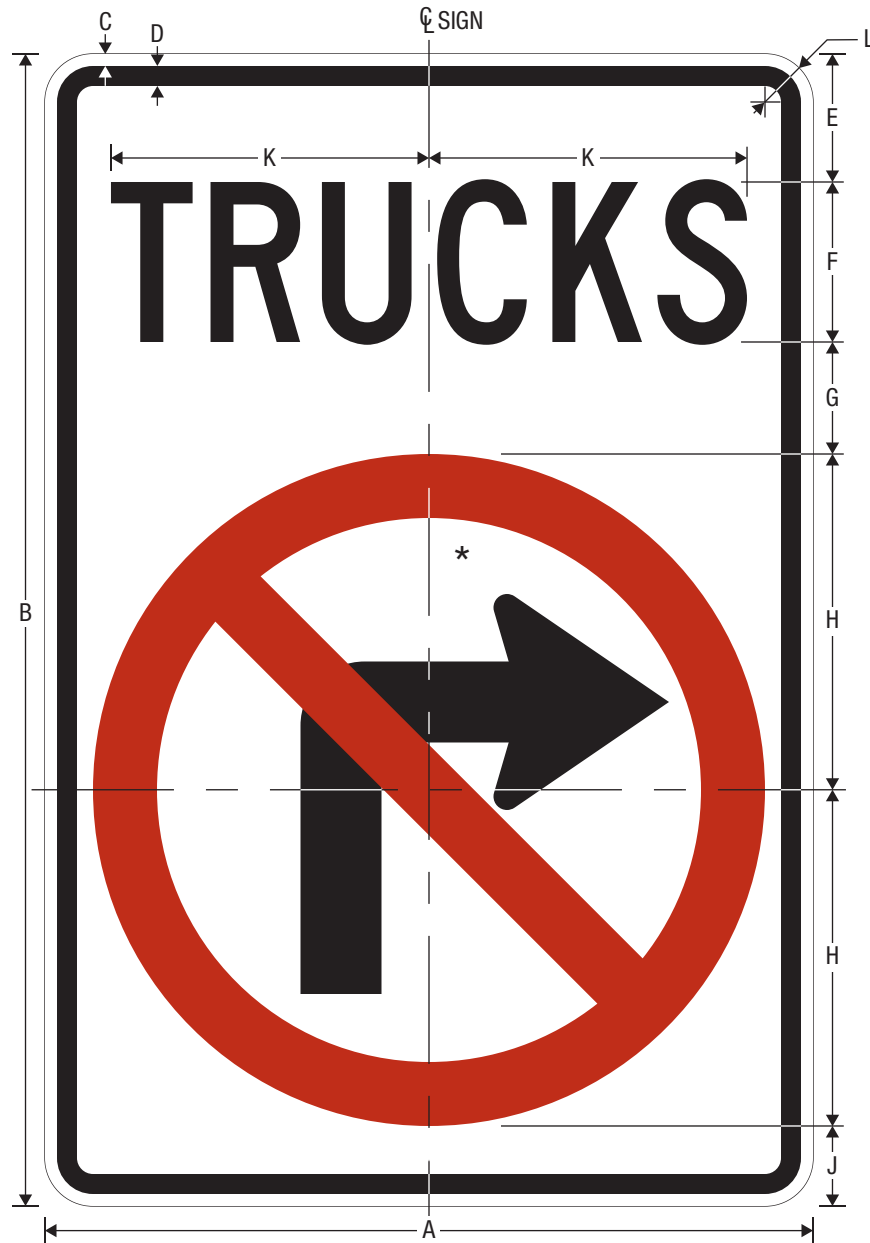

R3-1b

MOVEMENT PROHIBITION, VEHICLE CLASS - 1 LINE

\* NO RIGHT TURN shown as an example,  
see pages 2-39, 2-48, 2-51, 2-118, or 2-133  
for movement prohibition details.

A	B	C	D	E	F	G	H	J	K	L
24	36	0.375	0.625	4	5 C	3.5	10.5	2.5	VAR	1.5
36	54	0.625	0.875	6.75	7.5 C	5.25	15.75	3	VAR	2.25

COLORS: CIRCLE, DIAGONAL — RED (RETROREFLECTIVE)  
 LEGEND, ARROW, BORDER — BLACK  
 BACKGROUND — WHITE (RETROREFLECTIVE)



R3-1c

MOVEMENT PROHIBITION, VEHICLE CLASS - 2 LINES

\* NO RIGHT TURN shown as an example,  
see pages 2-39, 2-48, 2-51, 2-118, or 2-133  
for movement prohibition details.

A	B	C	D	E	F	G	H	J	K	L	M
24	42	0.375	0.625	4.5	4 D	3	10.5	2.5	VAR	VAR	1.5
36	60	0.625	0.875	5.5	6 D	4	15.75	3	VAR	VAR	2.25

COLORS: CIRCLE, DIAGONAL — RED (RETROREFLECTIVE)  
 LEGEND, ARROW, BORDER — BLACK  
 BACKGROUND — WHITE (RETROREFLECTIVE)

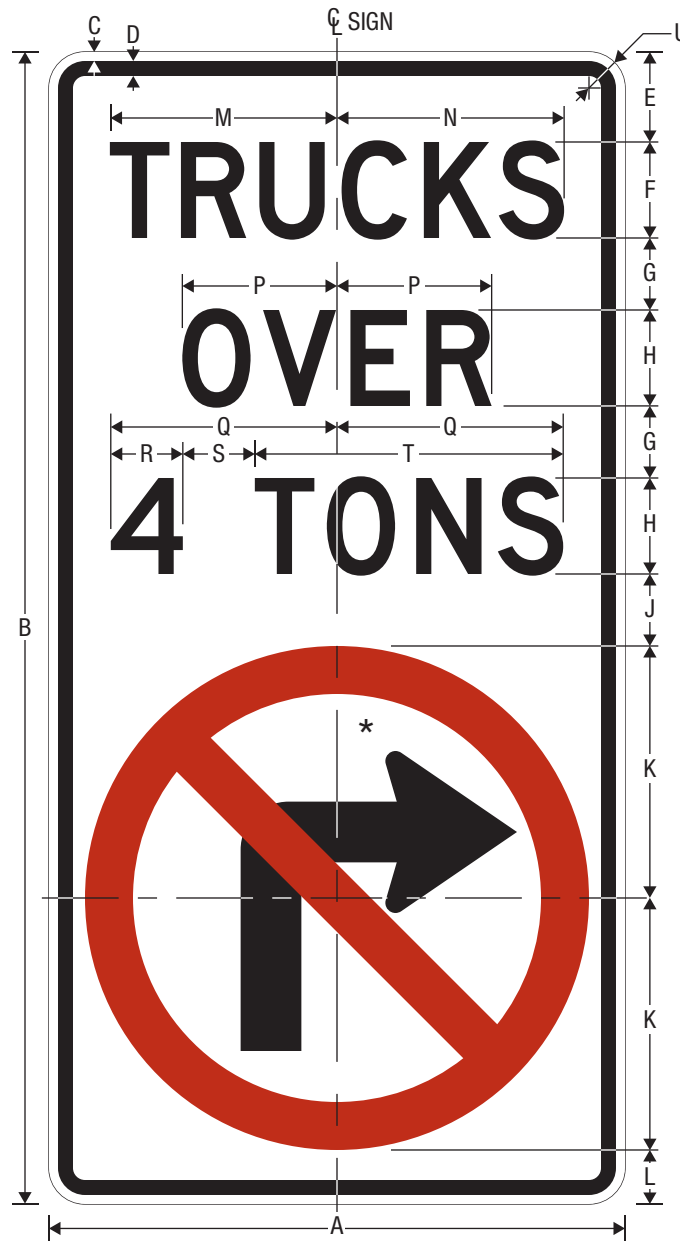

R3-1d

MOVEMENT PROHIBITION, VEHICLE CLASS - 3 LINES

\* NO RIGHT TURN shown as an example, see pages 2-39, 2-48, 2-51, 2-118, or 2-133 for movement prohibition details.

\*\* Reduce Spacing 20%.

A	B	C	D	E	F	G	H	J	K
24	48	0.375	0.625	3.75	4 D**	3	4 D	3	10.5
36	66	0.625	0.875	4.75	6 D**	3.5	6 D	2.5	15.75

L	M	N	P	Q	R	S	T	U
2.25	9.464	9.463	6.444	VAR	VAR	3	12.849	1.5
2.25	14.196	14.195	9.666	VAR	VAR	4.5	19.274	2.25

COLORS: CIRCLE, DIAGONAL — RED (RETROREFLECTIVE)  
 LEGEND, ARROW, BORDER — BLACK  
 BACKGROUND — WHITE (RETROREFLECTIVE)



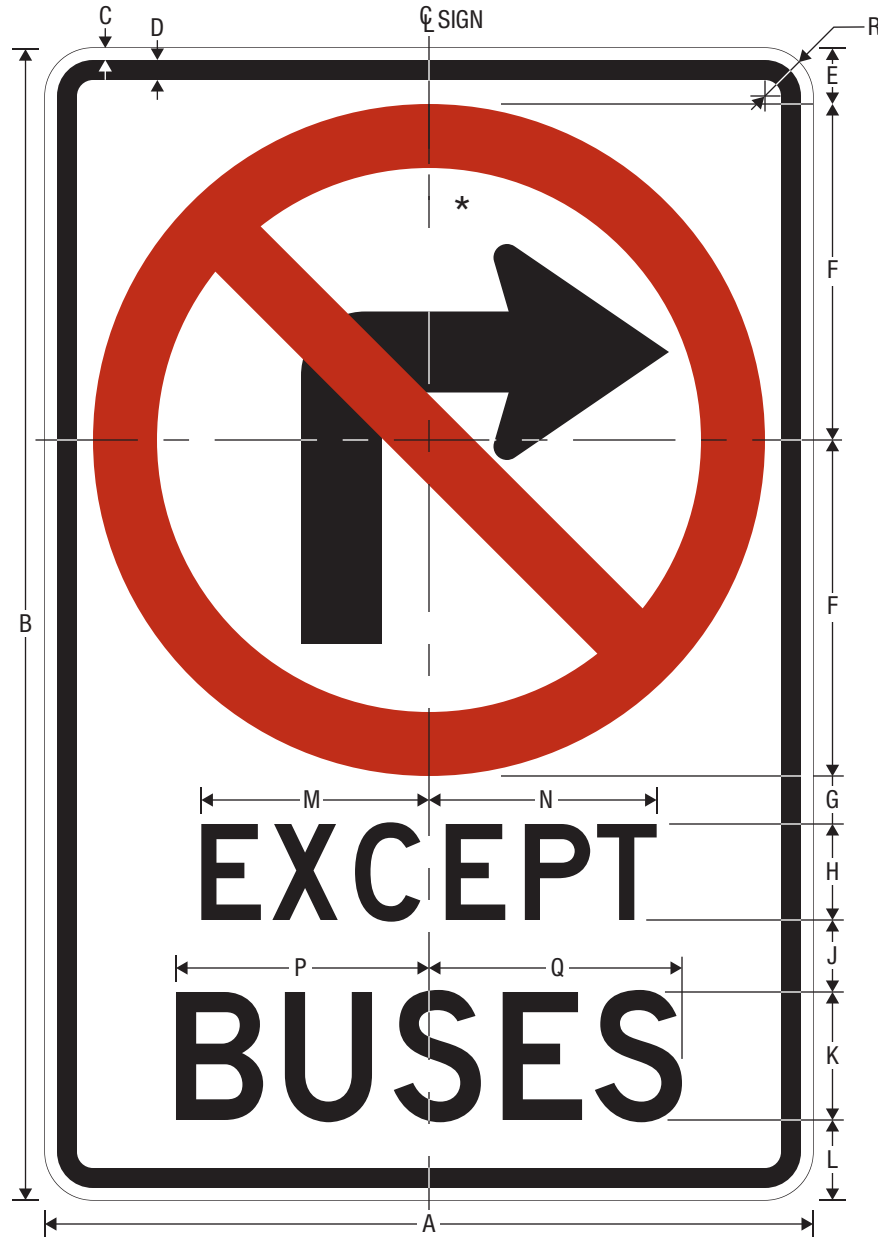

R3-1e

MOVEMENT PROHIBITION, VEHICLE EXCEPTION - 1 LINE

\* NO RIGHT TURN shown as an example, see pages 2-39, 2-48, 2-51, 2-118, or 2-133 for movement prohibition details.

\*\* Increase Spacing 20%.

\*\*\* Reduce Spacing 20%.

A	B	C	D	E	F	G	H
24	36	0.375	0.625	1.75	10.5	1.5	3 D**
36	54	0.625	0.875	2.5	15.75	2	5 D***

J	K	L	M	N	P	Q	R
2.25	4 D	2.5	7.115	7.114	VAR	VAR	1.5
3	6 D	4	11.158	11.157	VAR	VAR	2.25

COLORS: CIRCLE, DIAGONAL — RED (RETROREFLECTIVE)  
 LEGEND, ARROW, BORDER — BLACK  
 BACKGROUND — WHITE (RETROREFLECTIVE)

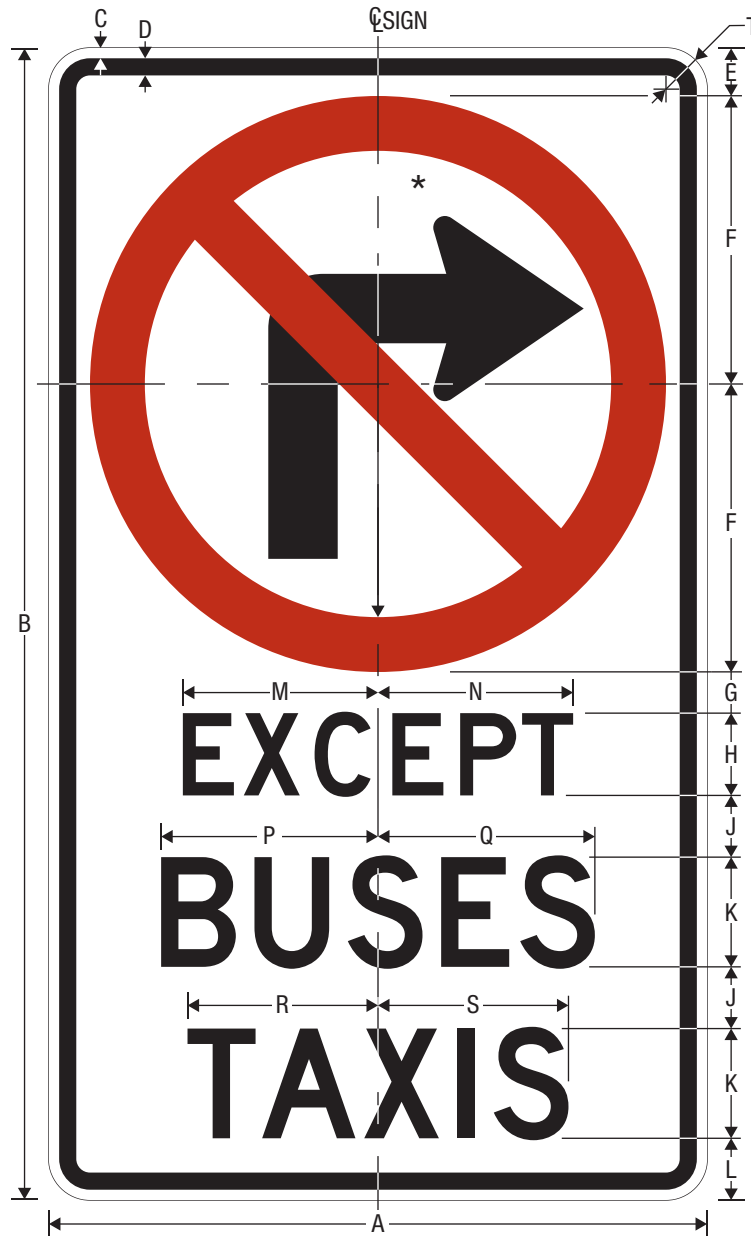

R3-1f

MOVEMENT PROHIBITION, VEHICLE EXCEPTION - 2 LINES

\* NO RIGHT TURN shown as an example, see pages 2-39, 2-48, 2-51, 2-118, or 2-133 for movement prohibition details.

\*\* Increase Spacing 20%.

\*\*\* Reduce Spacing 20%.

A	B	C	D	E	F	G	H	J
24	42	0.375	0.625	1.75	10.5	1.5	3 D**	2.25
36	66	0.625	0.875	3.5	15.75	3	5 D***	3

K	L	M	N	P	Q	R	S	T
4 D	2.25	7.115	7.114	VAR	VAR	VAR	VAR	1.5
6 D	5	11.158	11.157	VAR	VAR	VAR	VAR	2.25

COLORS: CIRCLE, DIAGONAL — RED (RETROREFLECTIVE)  
 LEGEND, ARROW, BORDER — BLACK  
 BACKGROUND — WHITE (RETROREFLECTIVE)

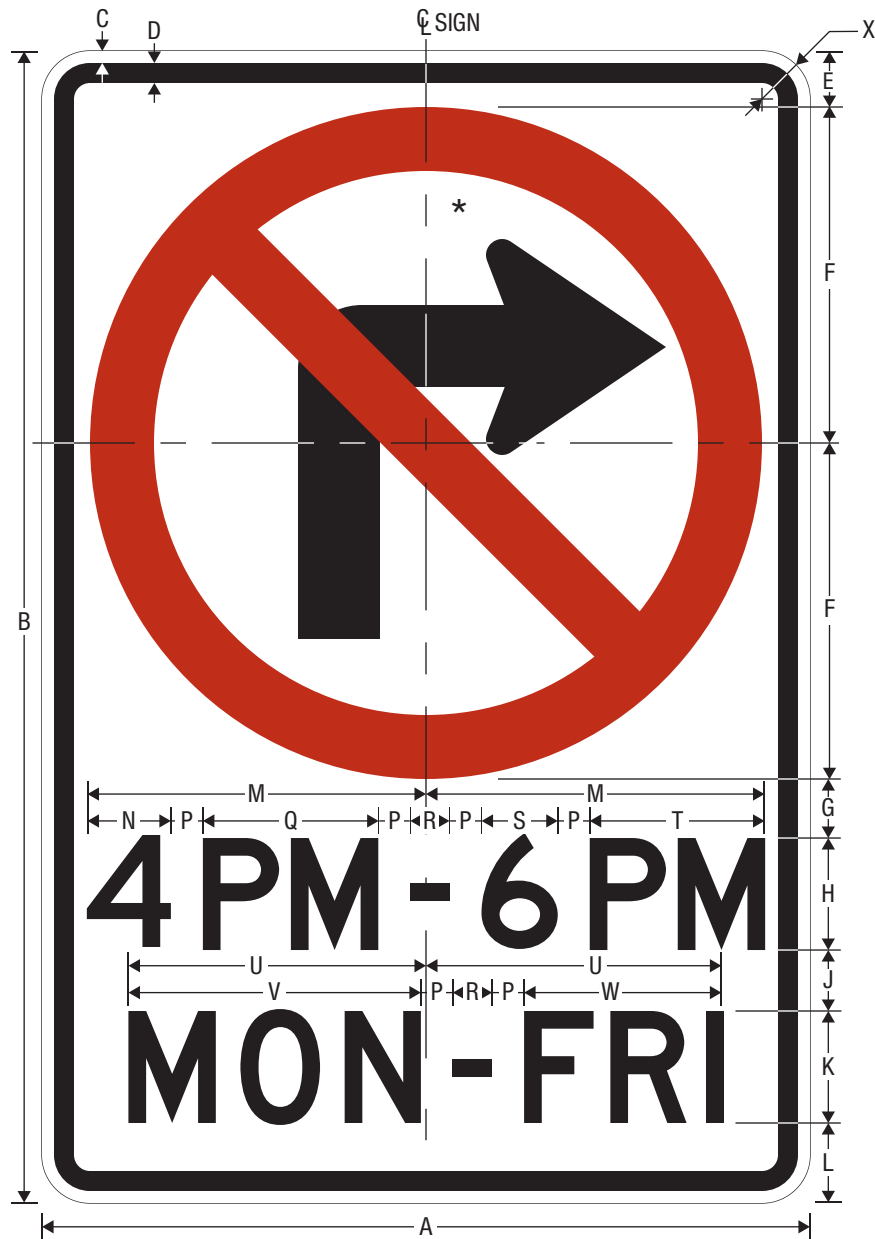

R3-1g

MOVEMENT PROHIBITION, PART-TIME - 2 LINE

\* NO RIGHT TURN shown as an example, see pages 2-39, 2-48, 2-51, 2-118, or 2-133 for movement prohibition details.

\*\* Reduce Spacing 30%.

A	B	C	D	E	F	G	H	J	K	L
24	36	0.375	0.625	1.75	10.5	1.75	3.5 D**	2	3.5 D	2.5
36	54	0.625	0.875	2.5	15.75	3	5 D	3	5 D	4

M	N	P	Q	R	S	T	U	V	W	X
VAR	VAR	1	VAR	1.225	VAR	VAR	VAR	VAR	VAR	1.5
VAR	VAR	1	VAR	1.75	VAR	VAR	VAR	VAR	VAR	2.25

COLORS: CIRCLE, DIAGONAL — RED (RETROREFLECTIVE)  
 LEGEND, ARROW, BORDER — BLACK  
 BACKGROUND — WHITE (RETROREFLECTIVE)



R3-1h

MOVEMENT PROHIBITION, PART-TIME - 3 LINE

\* NO RIGHT TURN shown as an example, see pages 2-39, 2-48, 2-51, 2-118, or 2-133 for movement prohibition details.

\*\* Reduce Spacing 30%.

A	B	C	D	E	F	G	H	J	K	L	M
24	42	0.375	0.625	1.75	10.5	2	3.5 D**	2	3.5 D	2.75	VAR
36	66	0.625	0.875	3.5	15.75	4	5 D	3.5	5 D	5	VAR

N	P	Q	R	S	T	U	V	W	X	Y
VAR	0.5	VAR	1	1.225	VAR	VAR	VAR	VAR	VAR	1.5
VAR	0.5	VAR	1	1.75	VAR	VAR	VAR	VAR	VAR	2.25

COLORS: CIRCLE, DIAGONAL — RED (RETROREFLECTIVE)  
 LEGEND, ARROW, BORDER — BLACK  
 BACKGROUND — WHITE (RETROREFLECTIVE)



R3-1h

MOVEMENT PROHIBITION, PART-TIME - 3 LINE

\* NO RIGHT TURN shown as an example, see pages 2-39, 2-48, 2-51, 2-118, or 2-133 for movement prohibition details.

\*\* Reduce Spacing 30%.

A	B	C	D	E	F	G	H	J	K	L
24	42	0.375	0.625	1.75	10.5	2	3.5 D**	2	3.5 D	2.75
36	66	0.625	0.875	3.5	15.75	4	5 D	3.5	5 D	5

M	N	P	Q	R	S	T	U	V	W
VAR	VAR	1	VAR	1.225	VAR	VAR	VAR	VAR	1.5
VAR	VAR	1.5	VAR	1.75	VAR	VAR	VAR	VAR	2.25

COLORS: CIRCLE, DIAGONAL — RED (RETROREFLECTIVE)  
 LEGEND, ARROW, BORDER — BLACK  
 BACKGROUND — WHITE (RETROREFLECTIVE)

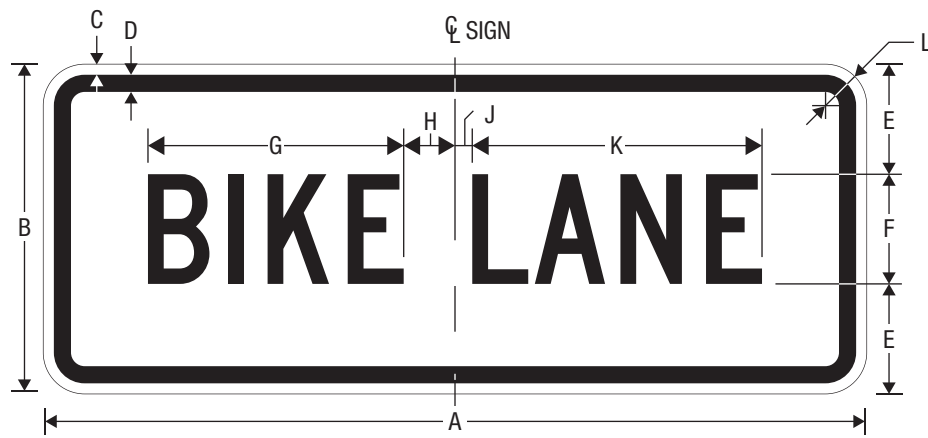

R3-5hP  
BIKE LANE (PLAQUE)

A	B	C	D	E	F	G	H	J	K	L
30	12	0.375	0.625	4	4 C	9.323	1.871	0.629	10.564	1.5

COLORS: LEGEND, BORDER — BLACK  
BACKGROUND — WHITE (RETROREFLECTIVE)

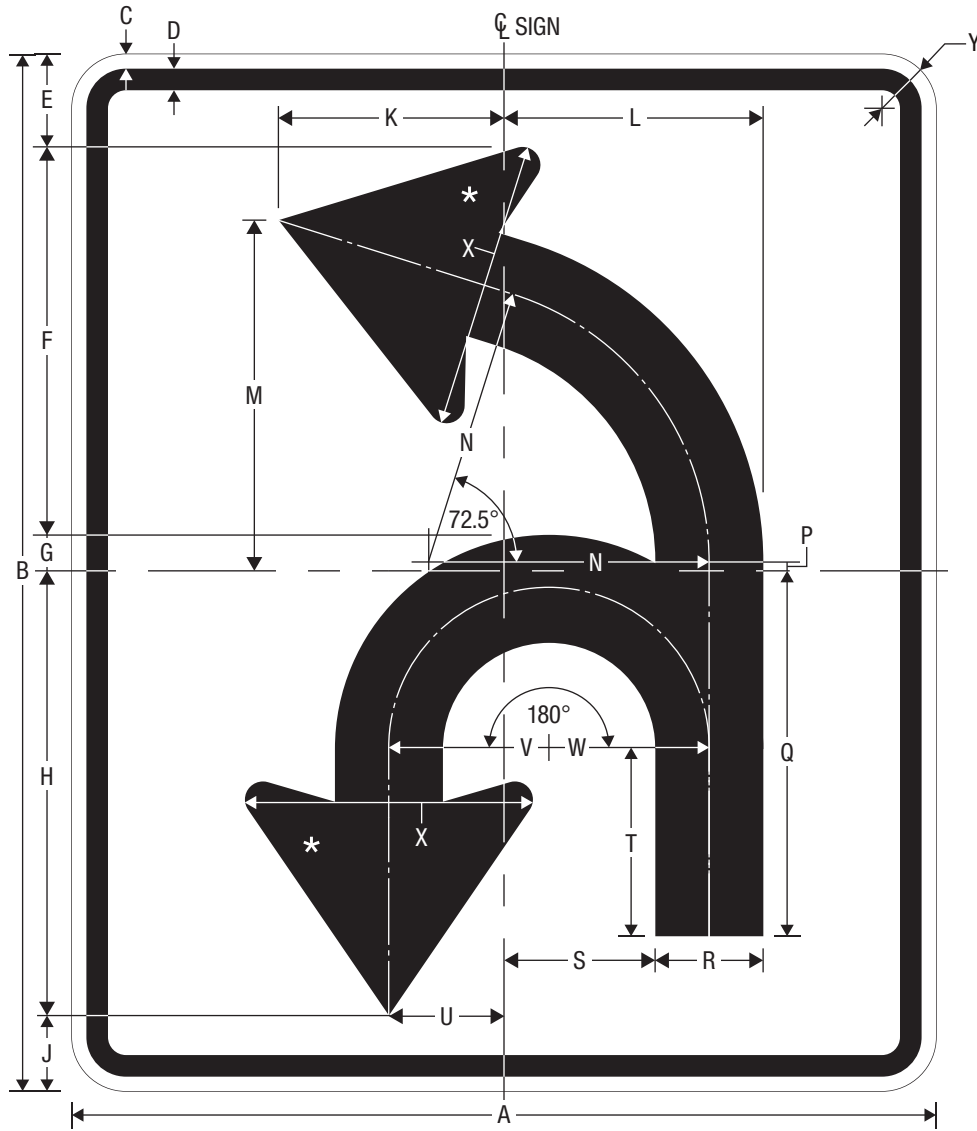

R3-6a

OPTIONAL MOVEMENT LANE CONTROL - U AND LEFT TURNS

\* See page 7-3 for arrow design.

A	B	C	D	E	F	G	H	J	K	L	M
30	36	0.5	0.75	3.217	13.470	1.313	15.375	2.625	7.833	9	12.240

N	P	Q	R	S	T	U	V	W	X	Y
9.75	0.375	12.625	3.75	5.25	6.5	4	5.563	5.562	10	1.875

COLORS: LEGEND, BORDER — BLACK  
BACKGROUND — WHITE (RETROREFLECTIVE)

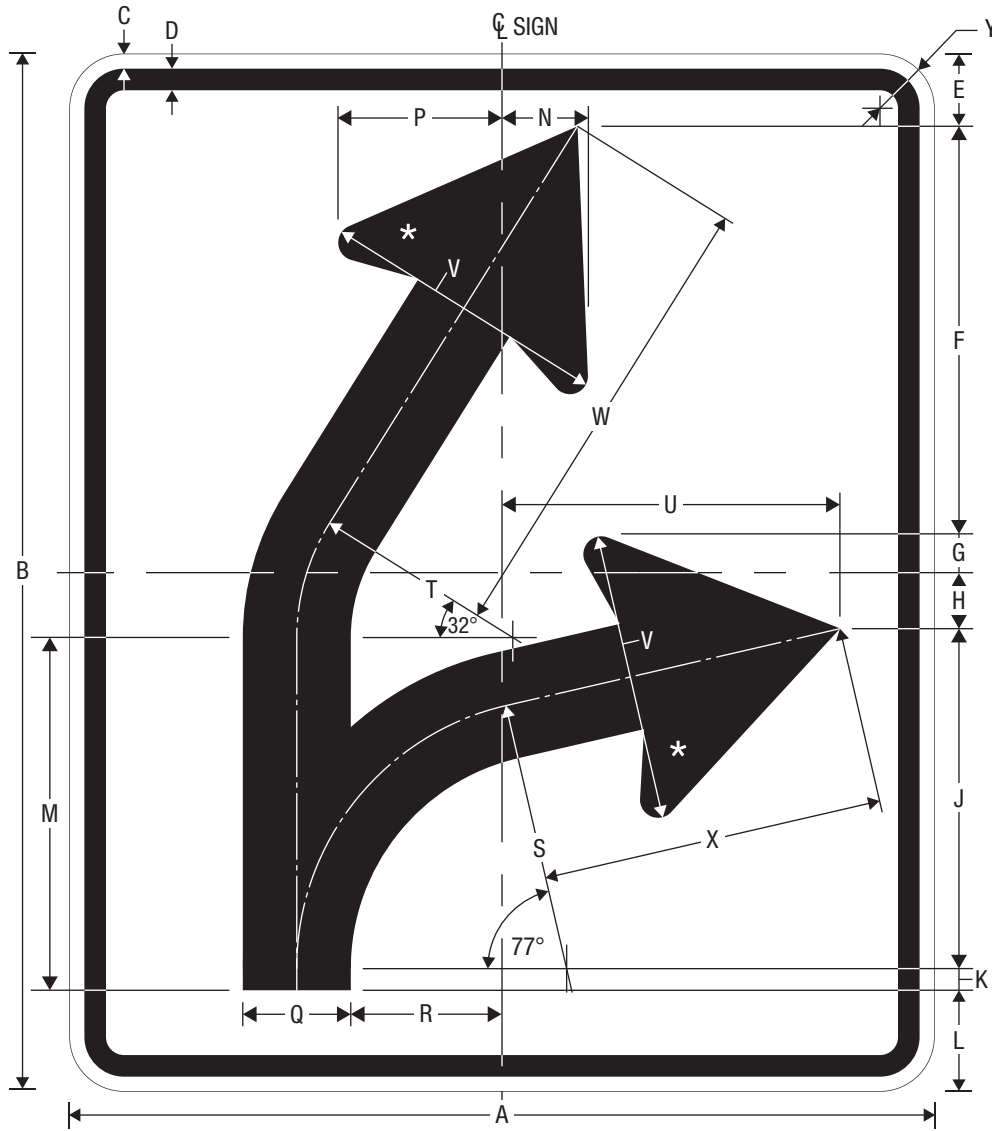

R3-6bR

OPTIONAL MOVEMENT LANE CONTROL - OBLIQUE

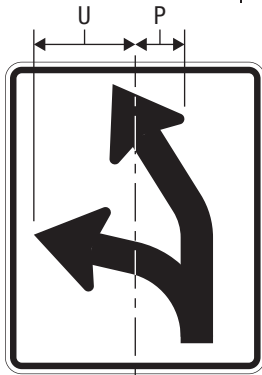

R3-6bL

\* See page 7-3 for arrow design.

A	B	C	D	E	F	G	H	J	K	L	M
30	36	0.5	0.75	2.5	14.237	1.263	1.937	11.813	0.75	3.5	11.5

N	P	Q	R	S	T	U	V	W	X	Y
2.983	5.687	3.75	5.25	9.375	7.5	11.741	10	16.244	11.905	1.875

COLORS: LEGEND, BORDER — BLACK  
BACKGROUND — WHITE (RETROREFLECTIVE)





R3-7R

RIGHT LANE MUST TURN RIGHT

\* Reduce Spacing 40%.

\*\* Reduce Spacing 20%.

A	B	C	D	E	F	G	H
30	0.5	0.75	4.5	4 C	4	5 C	12.164
36	0.625	0.875	5	5 C*	5	6 C	13.785
48	0.75	1.25	7	6.5 C**	6.5	8 C	18.844

J	K	L	M	N	P	Q	R
0.450	2.050	10.564	6.928	10.884	1.890	0.610	1.875
0.853	2.272	12.365	8.314	12.545	2.183	0.942	2.25
0.889	3.111	16.621	11.085	16.998	2.923	1.077	3

COLORS: LEGEND, BORDER – BLACK  
BACKGROUND – WHITE (RETROREFLECTIVE)



R3-7L

LEFT LANE MUST TURN LEFT

A	B	C	D	E	F	G	H
30	0.5	0.75	4.5	4 C	4	5 C	9.644
36	0.625	0.875	5	5 C	5	6 C	12.055
48	0.75	1.25	7	6.5 C	6.5	8 C	15.672

J	K	L	M	N	P	Q	R
1.710	0.790	10.564	6.928	10.884	0.630	1.870	1.875
2.138	0.987	13.205	8.314	13.605	0.788	2.337	2.25
2.748	1.252	17.167	11.085	17.687	0.993	3.007	3

COLORS: LEGEND, BORDER – BLACK  
BACKGROUND – WHITE (RETROREFLECTIVE)

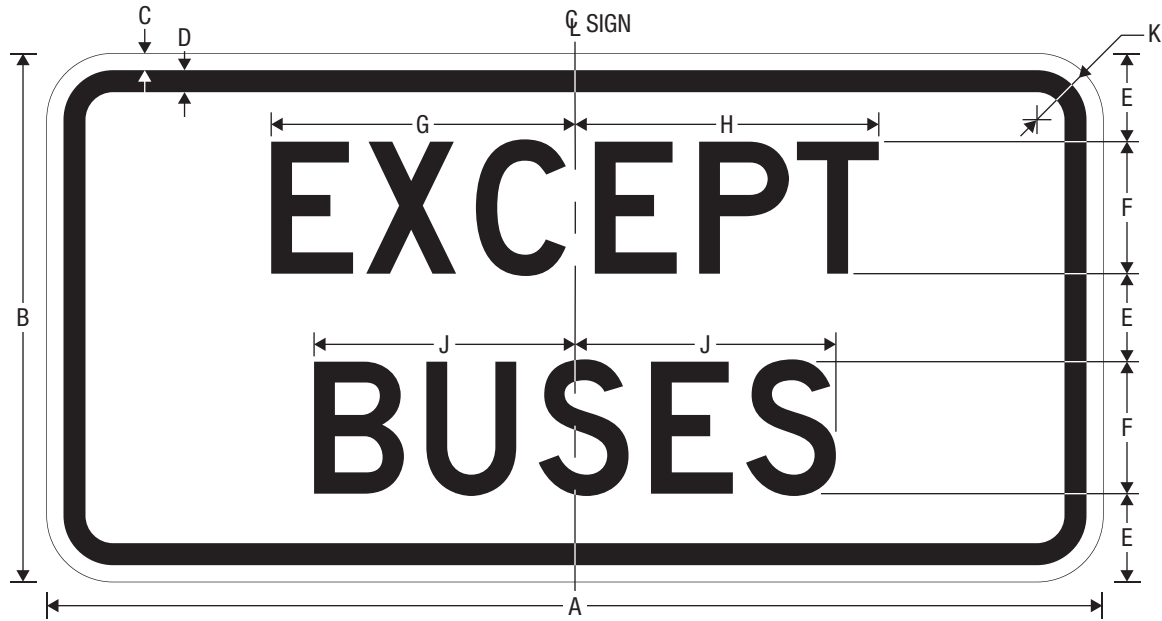

R3-7aP  
EXCEPT BUSES (PLAQUE)

A	B	C	D	E	F	G	H	J	K
24	12	0.375	0.5	2	3 D	6.905	6.904	5.930	1.5

COLORS: LEGEND, BORDER — BLACK  
BACKGROUND — WHITE (RETROREFLECTIVE)

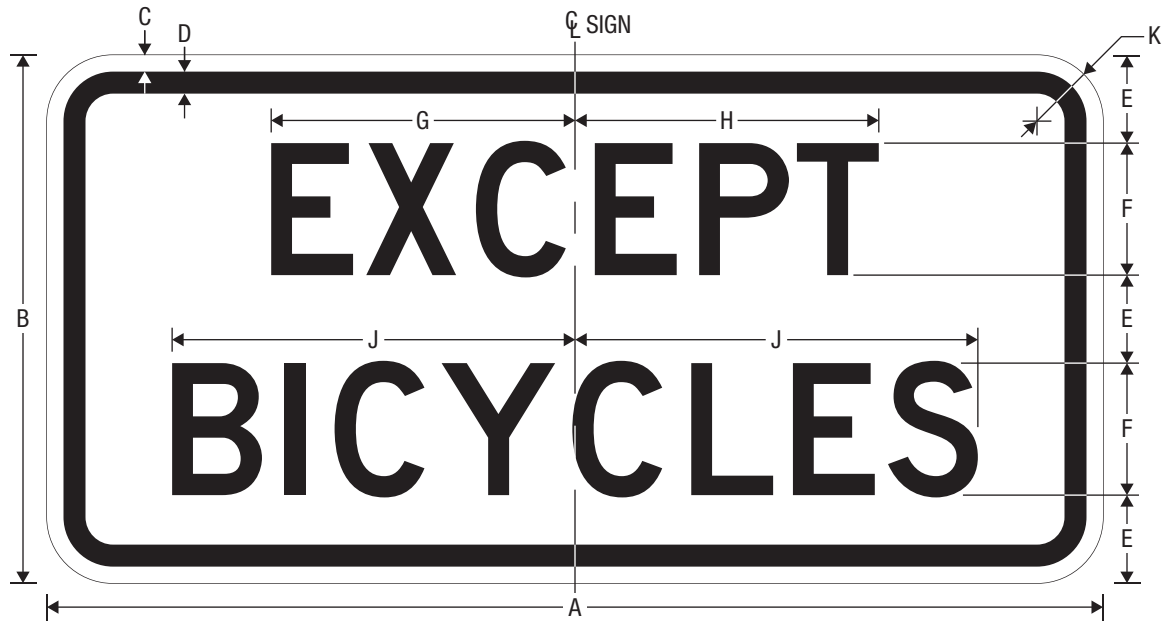

R3-7bP  
EXCEPT BICYCLES (PLAQUE)

A	B	C	D	E	F	G	H	J	K
24	12	0.375	0.5	2	3 D	6.905	6.904	9.156	1.5

COLORS: LEGEND, BORDER – BLACK  
BACKGROUND – WHITE (RETROREFLECTIVE)

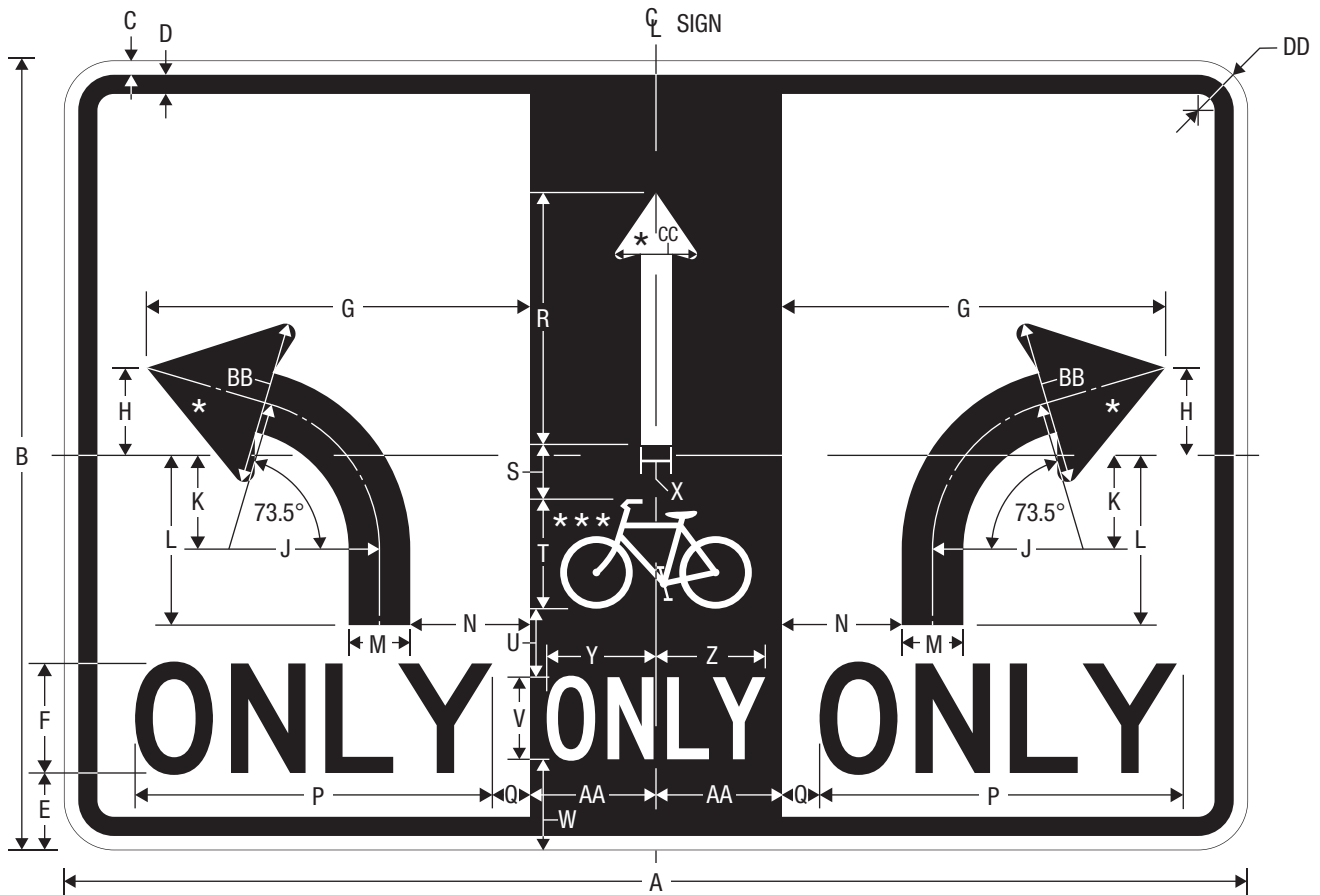

R3-8xa

ADVANCE INTERSECTION LANE CONTROL WITH BIKE LANE

- \* See page 7-3 for arrow design.
- \*\* Reduce Spacing 25%.
- \*\*\* See page 8-4 for symbol design.

A	B	C	D	E	F	G	H	J	K	L	M	N	P
54	36	0.625	0.875	3.5	5 D**	17.5	4	6.875	4.281	7.75	2.813	5.469	16.310
Q	R	S	T	U	V	W	X	Y	Z	AA	BB	CC	DD
1.720	10.75	2.5	5	3.125	3.75 C**	4.125	1.406	4.990	4.989	5.75	7.5	3.75	2.25

LEFT, RIGHT SECTIONS

COLORS: LEGEND, BORDER — BLACK  
BACKGROUND — WHITE (RETROREFLECTIVE)

CENTER SECTION

COLORS: LEGEND, BORDER — WHITE (RETROREFLECTIVE)  
BACKGROUND — BLACK

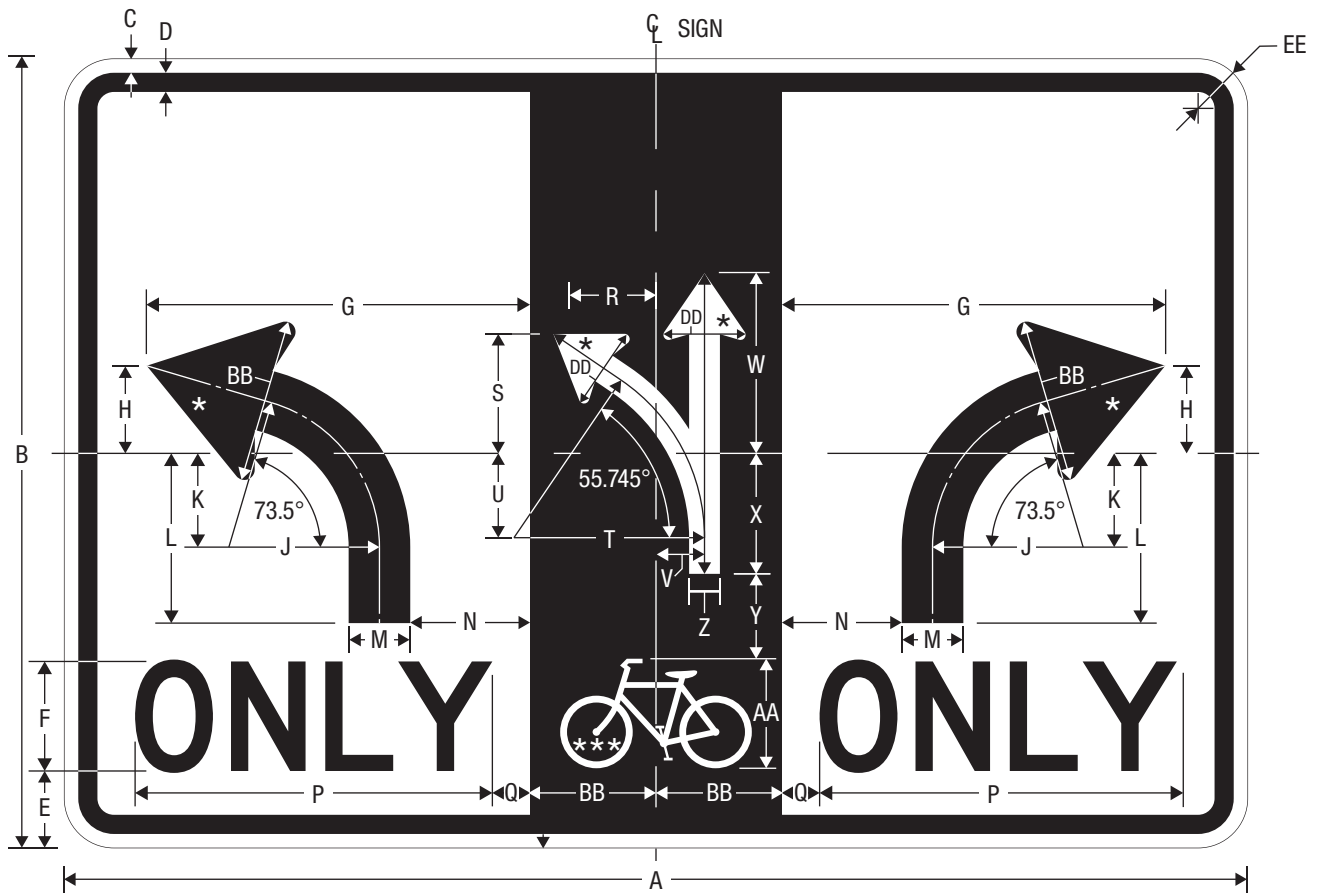

R3-8xb

ADVANCE INTERSECTION LANE CONTROL WITH BIKE LANE

- \* See page 7-3 for arrow design.
- \*\* Reduce Spacing 25%.
- \*\*\* See page 8-4 for symbol design.

A	B	C	D	E	F	G	H	J	K	L	M	N	P	Q
54	36	0.625	0.875	3.5	5 D**	17.5	4	6.875	4.281	7.75	2.813	5.469	16.310	1.720

R	S	T	U	V	W	X	Y	Z	AA	BB	CC	DD	EE
4.685	5.450	8.700	3.850	2.215	8.225	5.5	3.875	1.406	5	5.75	7.5	3.75	2.25

LEFT, RIGHT SECTIONS  
 COLORS: LEGEND, BORDER — BLACK  
 BACKGROUND — WHITE (RETROREFLECTIVE)

CENTER SECTION  
 COLORS: LEGEND, BORDER — WHITE (RETROREFLECTIVE)  
 BACKGROUND — BLACK

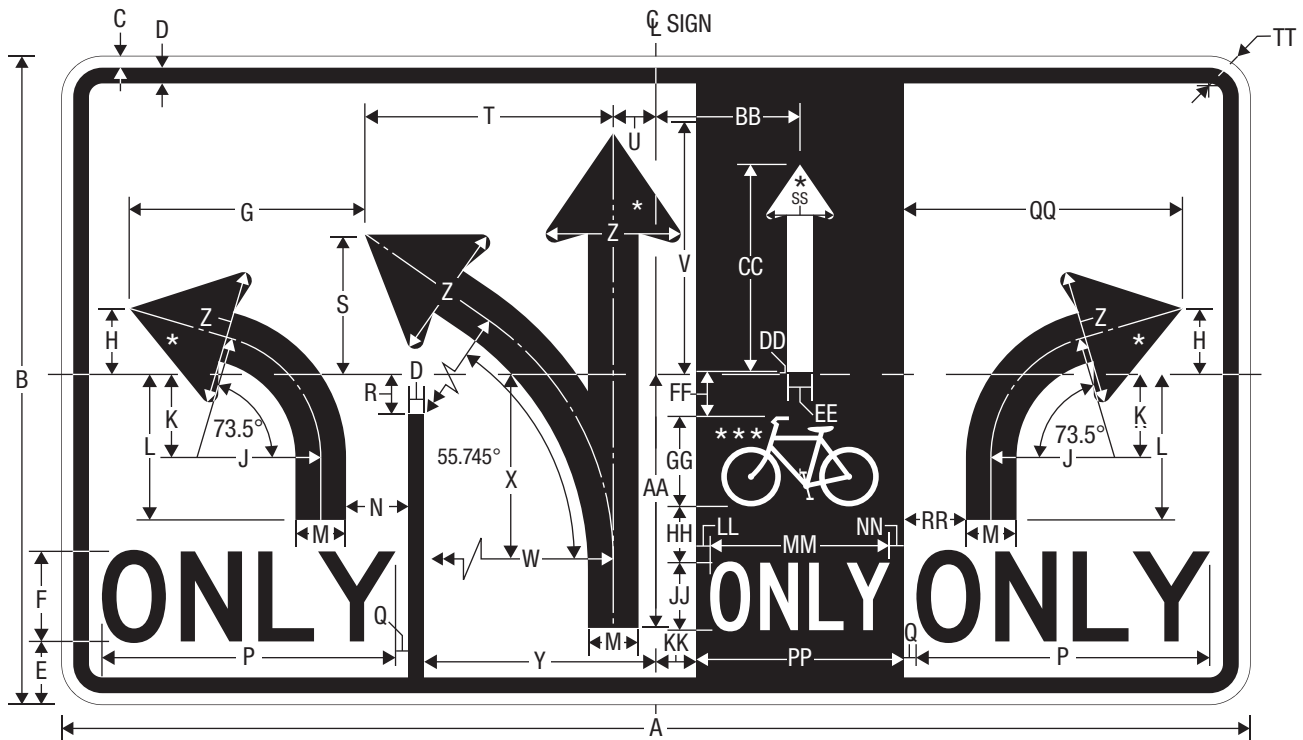

R3-8xc

ADVANCE INTERSECTION LANE CONTROL WITH BIKE LANE

- \* See page 7-3 for arrow design.
- \*\* Reduce Spacing 25%.
- \*\*\* See page 8-4 for symbol design.

A	B	C	D	E	F	G	H	J	K	L	M	N	P
66	36	0.625	0.875	3.5	5 D**	13.075	4	6.875	4.281	7.75	2.813	4.469	16.310
Q	R	S	T	U	V	W	X	Y	Z	AA	BB	CC	DD
0.720	3	8.100	13.800	2.375	13.75	17.400	9.5	12.875	7.5	13.75	8	10.75	0.5
EE	FF	GG	HH	JJ	KK	LL	MM	NN	PP	QQ	RR	SS	TT
1.406	2.5	5	3.125	3.75 C**	2.25	0.760	9.979	0.761	11.5	15.5	3.469	3.75	2.25

LEFT, RIGHT SECTIONS

COLORS: LEGEND, BORDER — BLACK  
BACKGROUND — WHITE (RETROREFLECTIVE)

CENTER SECTION

COLORS: LEGEND, BORDER — WHITE (RETROREFLECTIVE)  
BACKGROUND — BLACK

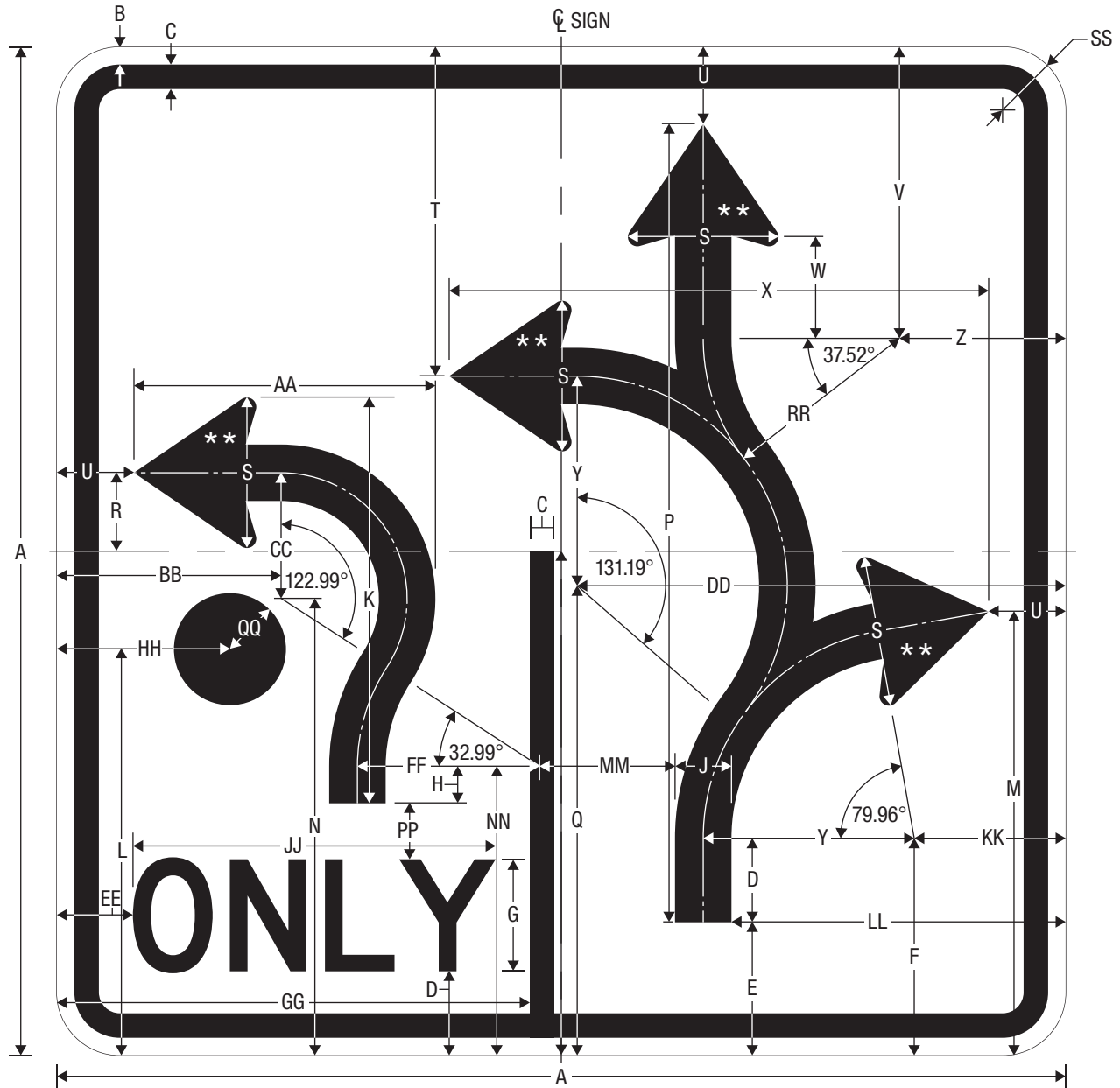

R3-8zd

ADVANCE CIRCULAR INTERSECTION LANE CONTROL (2 LANES)

\* Reduce Spacing 30%.  
\*\* See page 7-3 for arrow design.

A	B	C	D	E	F	G	H	J	K	L	M	N	P
36	0.625	0.875	3	4.75	7.75	4 D*	1.301	2.016	14.488	14.5	15.842	16.300	28.5
Q	R	S	T	U	V	W	X	Y	Z	AA	BB	CC	DD
16.75	2.800	5.375	11.75	2.75	10.418	3.637	19.25	7.5	5.933	10.757	8	4.5	17.433
EE	FF	GG	HH	JJ	KK	LL	MM	NN	PP	QQ	RR	SS	
2.706	6.5	16.875	6.178	12.944	5.433	11.925	4.833	10.310	2	2	7	2.25	

COLORS: LEGEND, BORDER – BLACK  
BACKGROUND – WHITE (RETROREFLECTIVE)



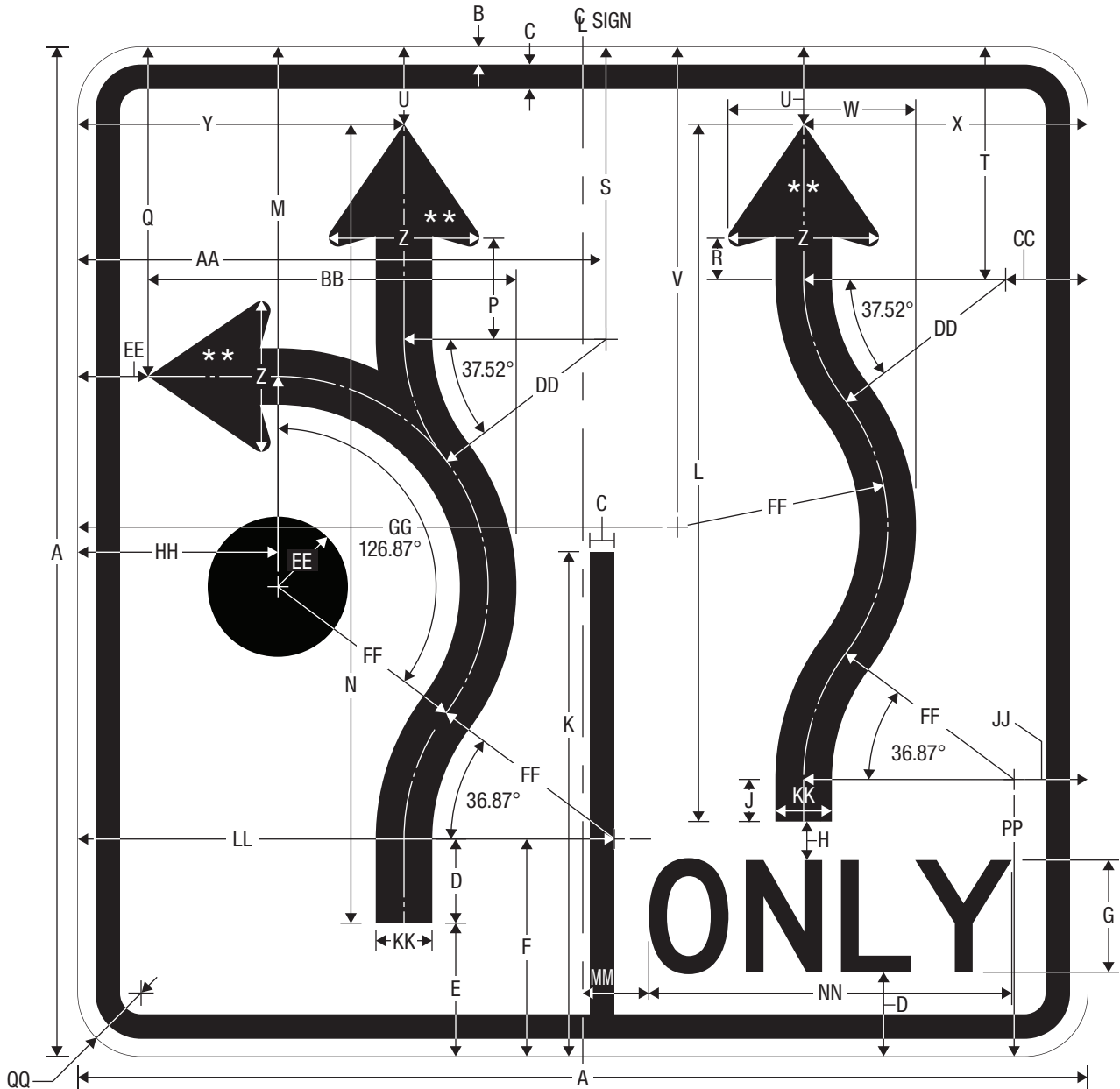

R3-8ze

ADVANCE CIRCULAR INTERSECTION LANE CONTROL (2 LANES)

\* Reduce Spacing 30%.

\*\* See page 7-3 for arrow design.

A	B	C	D	E	F	G	H	J	K	L	M	N
36	0.625	0.875	3	4.75	7.75	4 D*	1.375	1.5	18	24.875	19.25	28.5
P	Q	R	S	T	U	V	W	X	Y	Z	AA	BB
3.637	11.75	1.512	10.418	8.293	2.75	17.125	6.700	10.125	11.625	5.375	18.625	13.133
CC	DD	EE	FF	GG	HH	JJ	KK	LL	MM	NN	PP	QQ
3.125	7	2.5	7.5	21.375	7.125	2.625	2.016	19.125	2.354	12.944	9.875	2.25

COLORS: LEGEND, BORDER – BLACK  
BACKGROUND – WHITE (RETROREFLECTIVE)

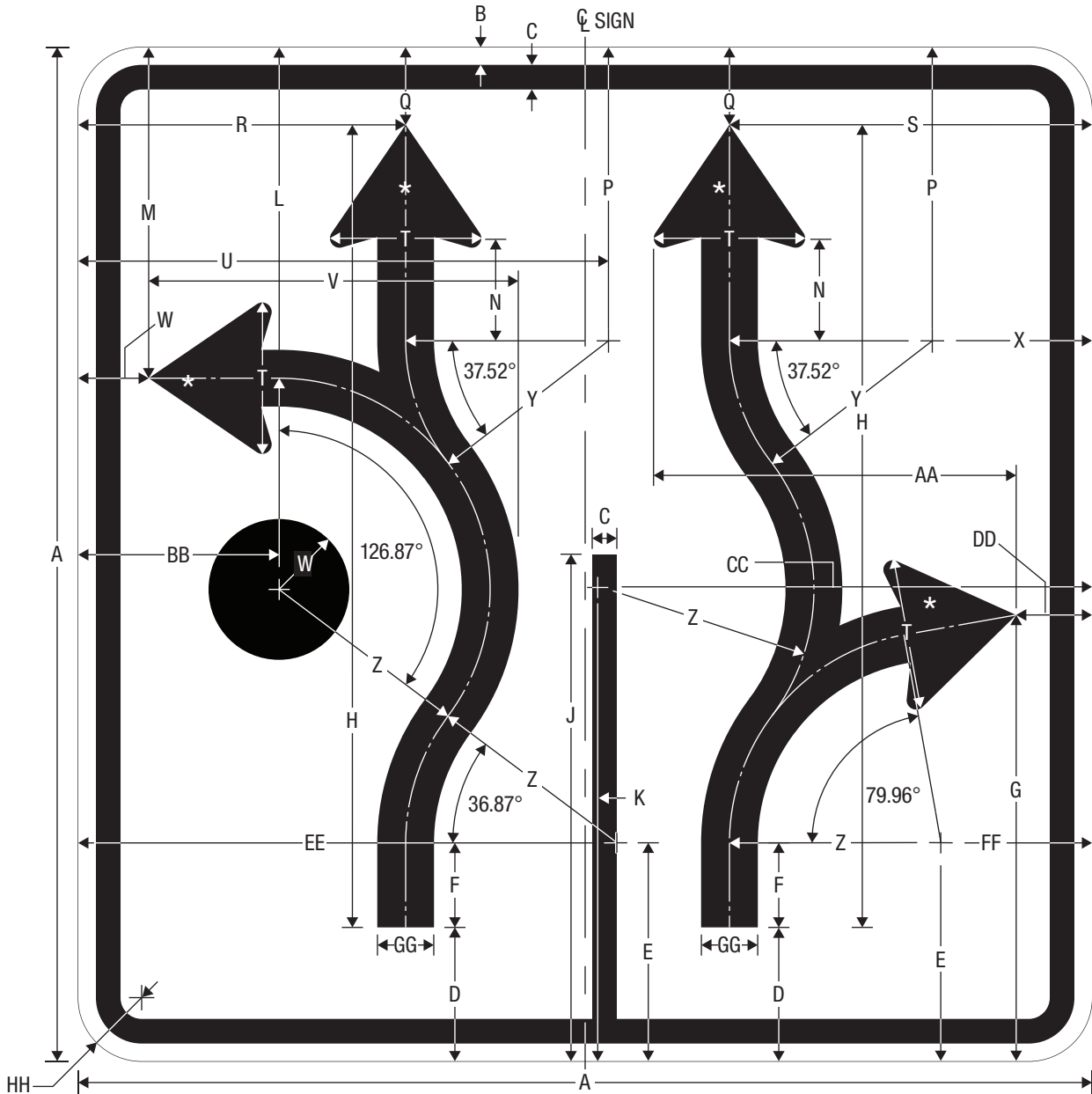

R3-8zf

ADVANCE CIRCULAR INTERSECTION LANE CONTROL (2 LANES)

\* See page 7-3 for arrow design.

A	B	C	D	E	F	G	H	J	K	L
36	0.625	0.875	4.75	7.75	3	15.842	28.5	18	16.75	19.25

M	N	P	Q	R	S	T	U	V	W	X
11.722	3.637	10.419	2.75	11.625	12.933	5.375	18.625	13.133	2.5	5.933

Y	Z	AA	BB	CC	DD	EE	FF	GG	HH
7	7.5	12.870	7.125	17.433	2.75	19.125	5.433	2.016	2.25

COLORS: LEGEND, BORDER – BLACK  
BACKGROUND – WHITE (RETROREFLECTIVE)

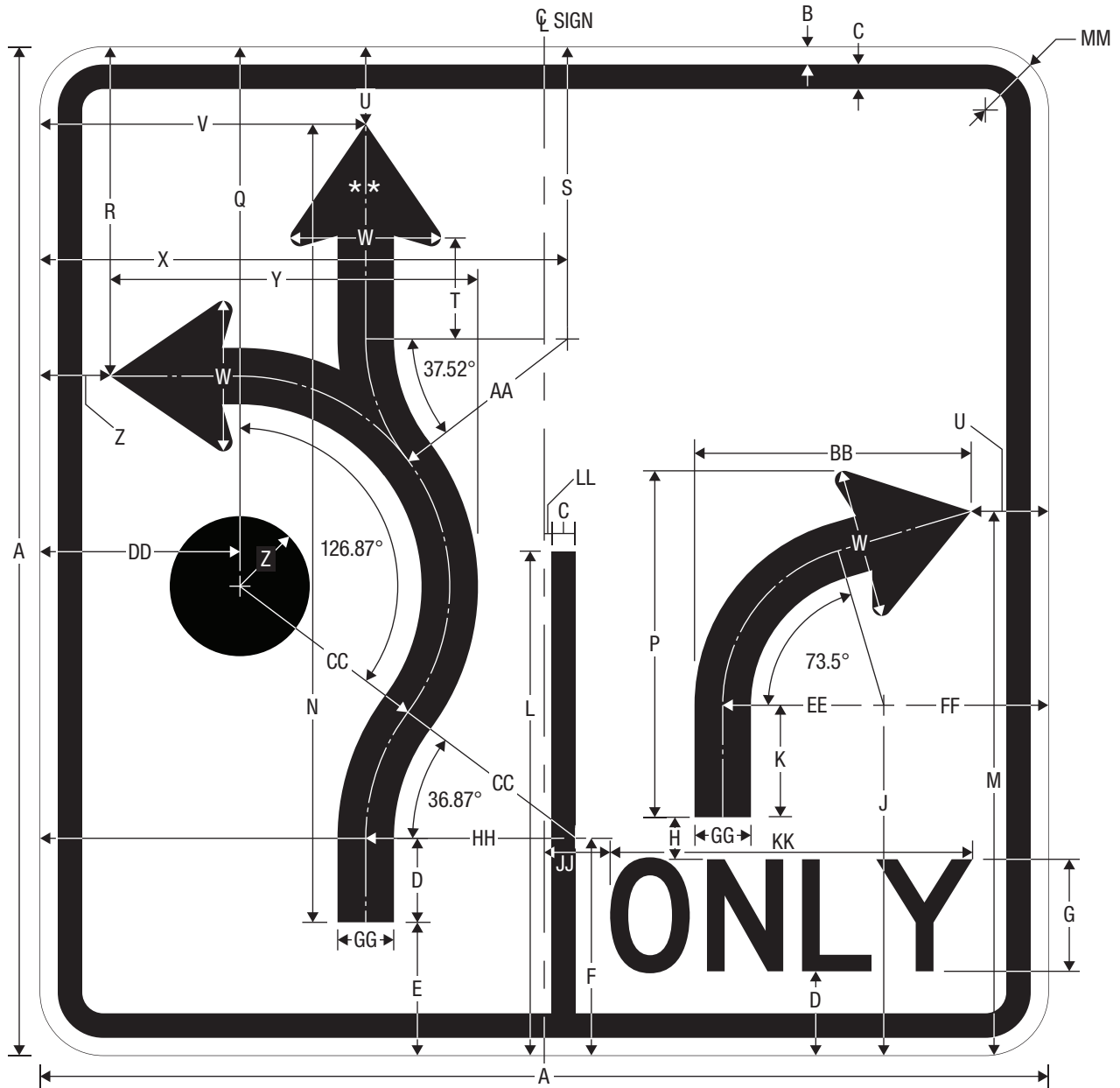

R3-8zg

ADVANCE CIRCULAR INTERSECTION LANE CONTROL (2 LANES)

\* Reduce Spacing 30%.

\*\* See page 7-3 for arrow design.

A	B	C	D	E	F	G	H	J	K	L	M
36	0.625	0.875	3	4.75	7.75	4D*	1.5	12.5	4	18	19.423

N	P	Q	R	S	T	U	V	W	X	Y	Z
28.5	12.368	19.25	11.75	10.418	3.637	2.75	11.625	5.375	18.625	13.133	2.5

AA	BB	CC	DD	EE	FF	GG	HH	JJ	KK	LL	MM
7	9.833	7.5	7.125	5.75	5.875	2.016	19.125	2.354	12.944	0.25	2.25

COLORS: LEGEND, BORDER – BLACK  
BACKGROUND – WHITE (RETROREFLECTIVE)

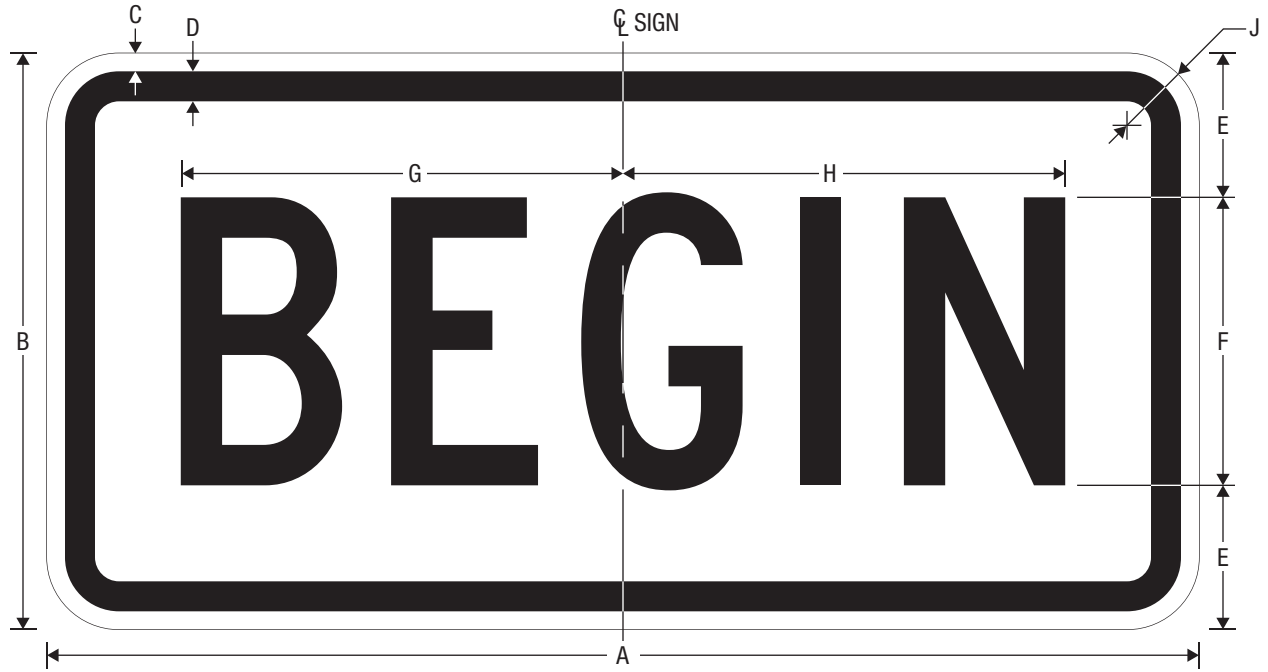

R3-9cP  
BEGIN (PLAQUE)

A	B	C	D	E	F	G	H	J
24	12	0.375	0.625	3	6 C	9.213	9.213	1.5
36	18	0.375	0.625	4.5	9 C	13.820	13.819	1.5

COLORS: LEGEND, BORDER – BLACK  
BACKGROUND – WHITE (RETROREFLECTIVE)

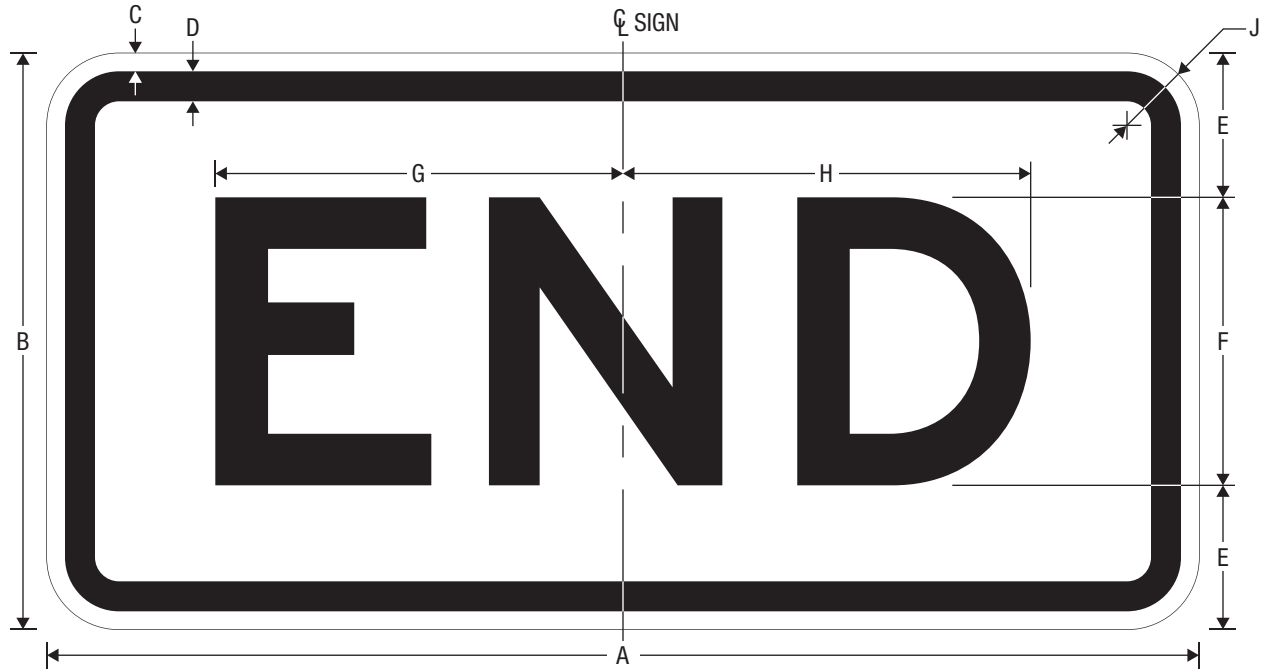

R3-9dP  
END (PLAQUE)

A	B	C	D	E	F	G	H	J
24	12	0.375	0.625	3	6 E	8.493	8.493	1.5
36	18	0.375	0.625	4.5	9 E	12.740	12.739	1.5

COLORS: LEGEND, BORDER — BLACK  
BACKGROUND — WHITE (RETROREFLECTIVE)

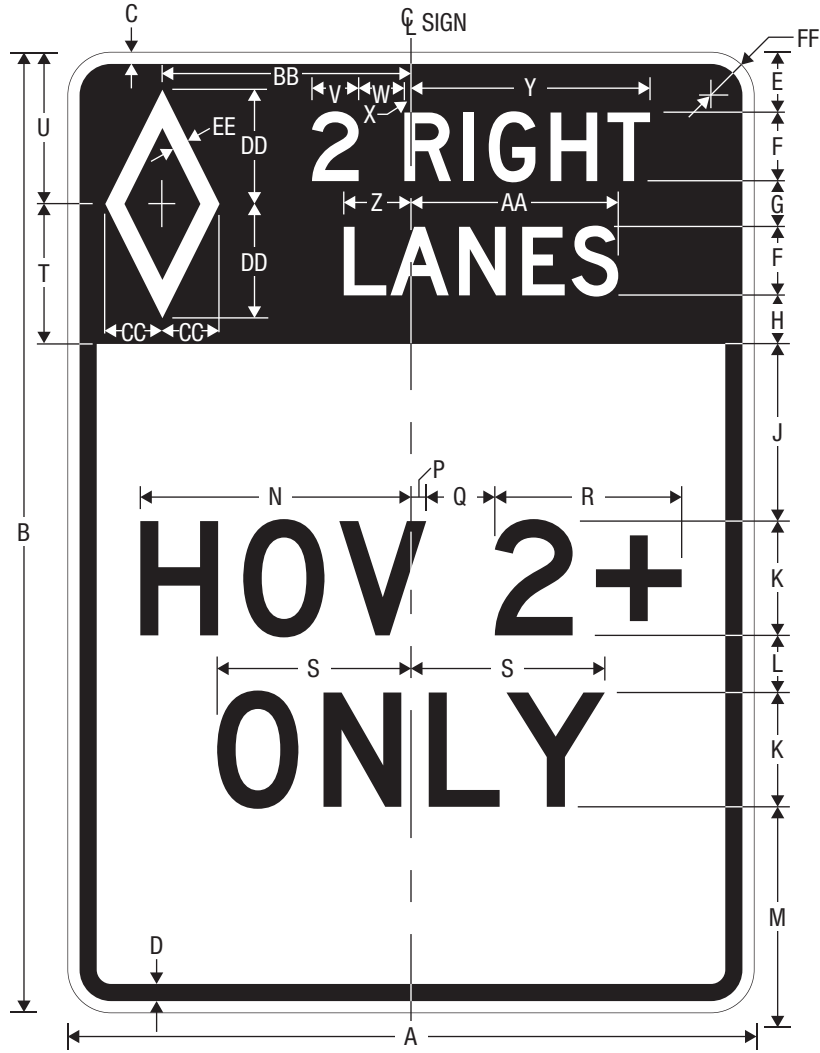

R3-11c

PREFERENTIAL LANE OPERATION - HIGH-OCCUPANCY VEHICLES, FULL-TIME (POST-MOUNTED)

A	B	C	D	E	F	G	H	J	K	L	M	N	P	Q
30	42	0.5	0.75	2.625	3 D	2	2.125	7.75	5 D	2.5	9	11.842	0.667	3
36	60	0.625	0.875	3.625	4 D	3	3	13	6 D	3	14.375	14.160	0.851	3.5
78	96	0.75	1.25	6.25	8 E	5.5	5.5	17.875	10 E	5	19.875	27.433	1.982	8

R	S	T	U	V	W	X	Y	Z	AA	BB	CC	DD	EE	FF
8.175	8.480	6.125	6.625	VAR	2	0.290	10.458	2.942	9.066	10.875	2.5	5	0.75	1.875
9.810	10.176	8.5	9.125	VAR	2.5	0.303	14.027	3.755	12.255	12.375	3.5	7	1.125	2.25
17.451	19.959	16.25	17	VAR	6	1.710	31.822	10.417	27.917	28	6.5	13	2	3

UPPER SECTION

COLORS: LEGEND — WHITE (RETROREFLECTIVE)  
BACKGROUND — BLACK

LOWER SECTION

COLORS: LEGEND, BORDER — BLACK  
BACKGROUND — WHITE (RETROREFLECTIVE)

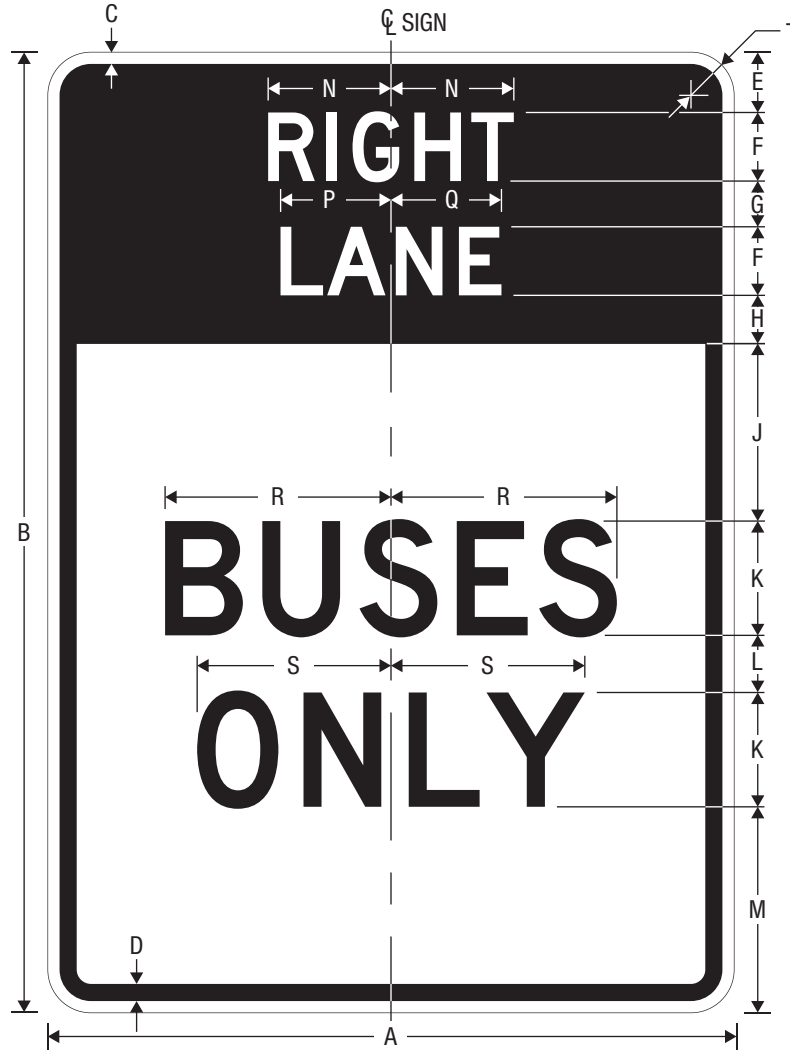

R3-11e

PREFERENTIAL LANE OPERATION - FULL-TIME (POST-MOUNTED)

A	B	C	D	E	F	G	H	J
30	42	0.5	0.75	2.625	3 D	2	2.125	7.75
36	60	0.625	0.875	3.625	4 D	3	3	13
78	96	0.75	1.25	6.25	8 E	5.5	5.5	17.875

K	L	M	N	P	Q	R	S	T
5 D	2.5	9	5.374	4.833	4.832	9.883	8.480	1.875
6 D	3	14.375	7.165	6.444	6.443	11.860	10.176	2.25
10 E	5	19.875	16.766	15.365	15.365	23.660	19.959	3

UPPER SECTION

COLORS: LEGEND, BORDER — WHITE (RETROREFLECTIVE)  
BACKGROUND — BLACK

LOWER SECTION

COLORS: LEGEND, BORDER — BLACK  
BACKGROUND — WHITE (RETROREFLECTIVE)

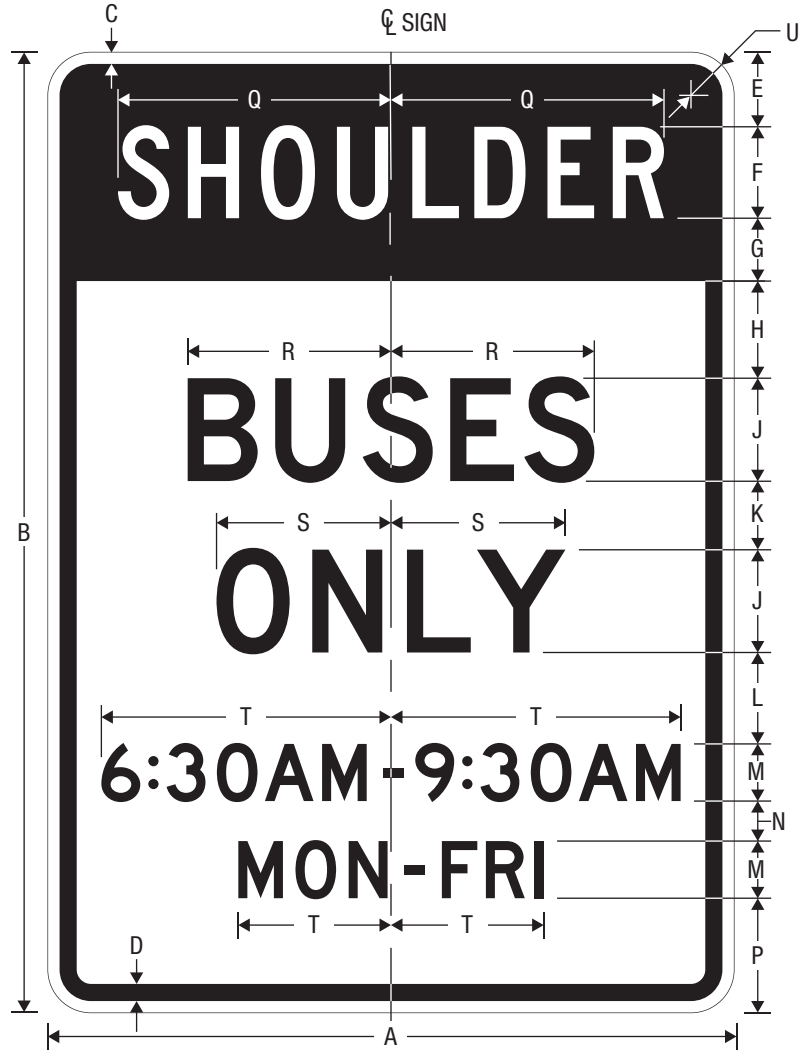

R3-11f

PREFERENTIAL LANE OPERATION (POST-MOUNTED)

\* Increase Spacing 20%.

A	B	C	D	E	F	G	H	J	K
30	42	0.5	0.75	3.25	4 C*	2.75	4.25	4.5 D	3
36	60	0.625	0.875	5.625	5 C*	5	6.125	6 D	5
78	96	0.75	1.25	10	10 D	9.25	7.75	10 E	7

L	M	N	P	Q	R	S	T	U
4	2.5 D	1.75	5	11.944	8.895	7.632	VAR	1.875
5.375	3 D	3.25	6.625	14.930	11.860	10.176	VAR	2.25
8.125	5 E	5	8.875	33.724	23.660	19.959	VAR	3

UPPER SECTION

COLORS: LEGEND — WHITE (RETROREFLECTIVE)  
BACKGROUND — BLACK

LOWER SECTION

COLORS: LEGEND, BORDER — BLACK  
BACKGROUND — WHITE (RETROREFLECTIVE)





R3-11g

PREFERENTIAL LANE OPERATION - FULL-TIME (POST-MOUNTED)

\* Increase Spacing 20%.  
\*\* Reduce Spacing 30%.

A	B	C	D	E	F	G	H	J	K	L	M	N	P	Q
30	42	0.5	0.75	3.5	4 C*	2.125	2.75	4 C	2.5	4 C**	2.5	2.5 D	1.75	5
36	60	0.625	0.875	5.625	5 C*	5	5.125	4.5 C	2.875	4.5 C**	5.125	3 D	3.25	5.625
78	96	0.75	1.25	10	10 D	9.25	5.5	8 D	4.5	8 D	6.75	5 E	5	6.5

R	S	T	U	V	W	X	Y	Z	AA	BB	CC	DD	EE
11.944	11.944	12.254	1.271	2.5	8.483	11.312	1.75	-	12.965	5.562	5.562	VAR	1.875
14.930	14.930	13.817	1.399	2.875	9.543	12.726	2	-	14.586	6.258	6.257	VAR	2.25
33.724	33.723	29.721	1.905	7	20.816	28.660	4.463	0.537	32.856	13.568	13.568	VAR	3

UPPER SECTION

COLORS: LEGEND, BORDER — WHITE (RETROREFLECTIVE)  
BACKGROUND — BLACK

LOWER SECTION

COLORS: LEGEND, BORDER — BLACK  
BACKGROUND — WHITE (RETROREFLECTIVE)

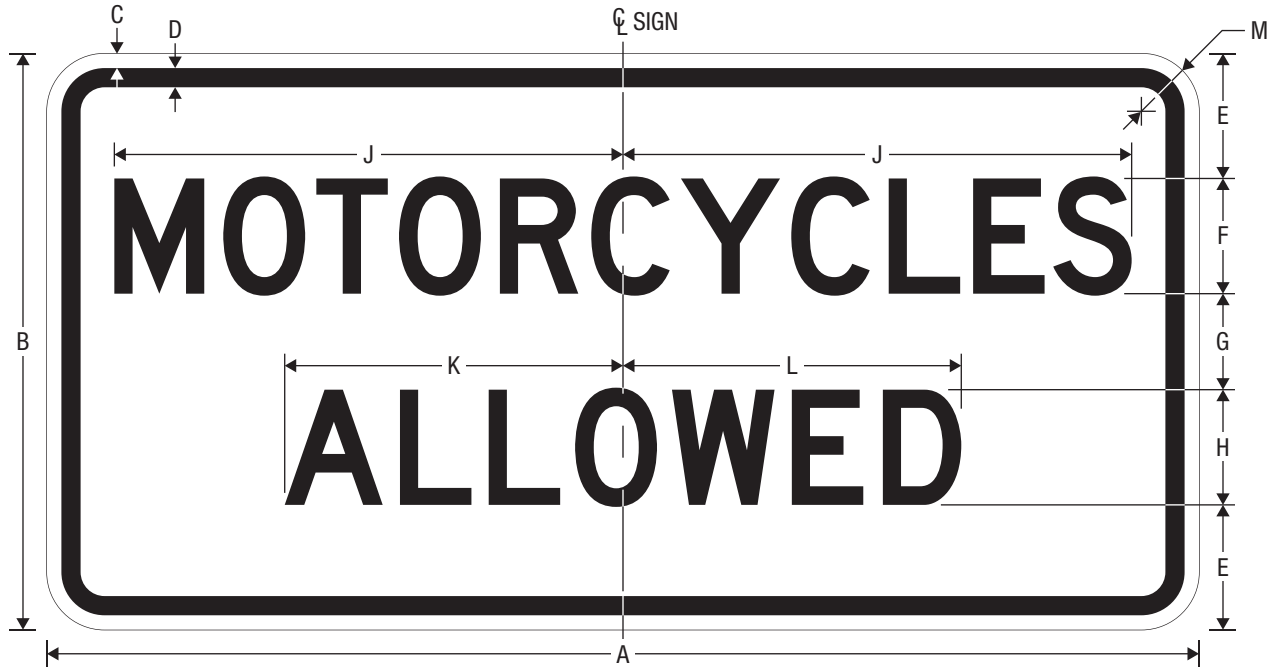

R3-11hP  
MOTORCYCLES ALLOWED (PLAQUE)

\* Reduce Spacing 25%.

A	B	C	D	E	F	G	H	J	K	L	M
30	15	0.375	0.5	3.25	3 D*	2.5	3 D	13.246	8.810	8.809	1.5
36	18	0.375	0.625	3.5	4 C	3	4 D	15.486	11.746	11.746	1.5
78	36	0.625	0.875	7	8 D*	6	8 D	35.323	23.492	23.492	2.25

COLORS: LEGEND, BORDER — BLACK  
BACKGROUND — WHITE (RETROREFLECTIVE)

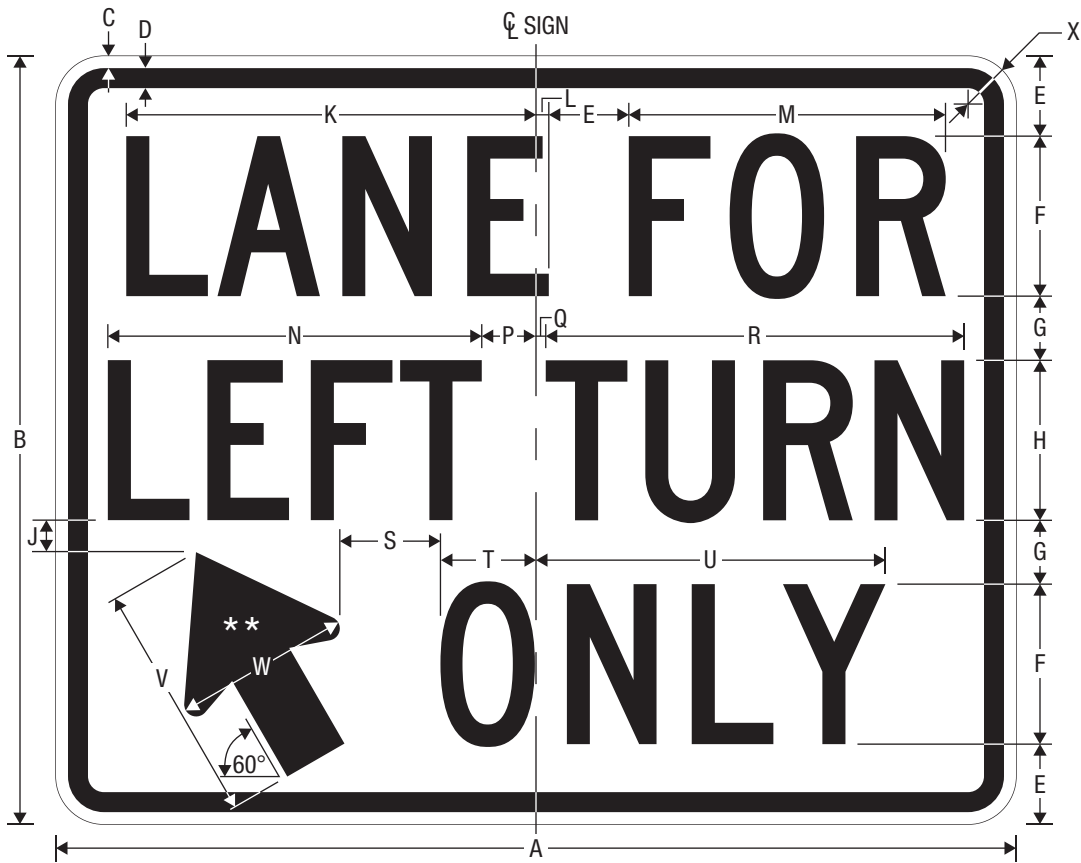

R3-19  
LANE FOR LEFT TURN ONLY

\* Reduce Spacing 20%.

\*\* See page 7-3 for arrow design.

A	B	C	D	E	F	G	H	J	K	L
30	24	0.375	0.625	2.5	5 C	2	5 C*	1	12.804	0.401

M	N	P	Q	R	S	T	U	V	W	X
9.904	11.685	1.695	0.305	13.075	3	2.986	10.919	7.5	5.5	1.5

COLORS: LEGEND, BORDER – BLACK  
BACKGROUND – WHITE (RETROREFLECTIVE)

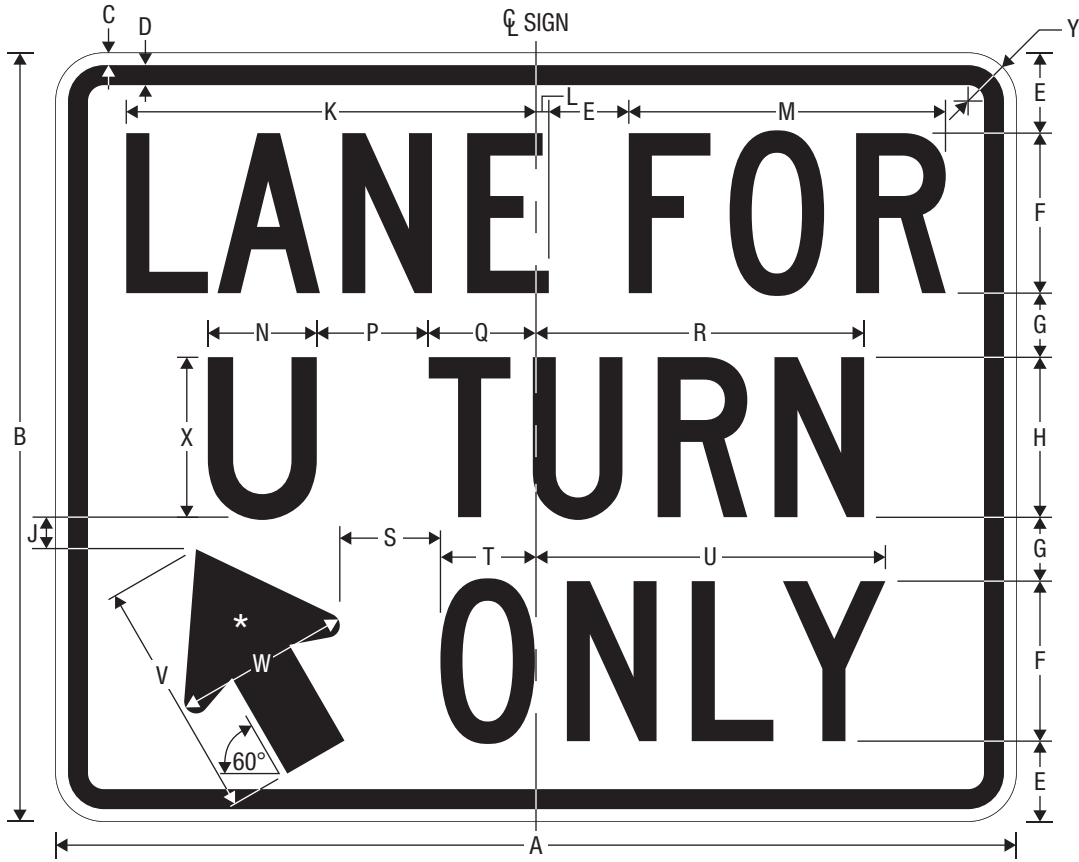

R3-19a  
LANE FOR U TURN ONLY

\* See page 7-3 for arrow design.

A	B	C	D	E	F	G	H	J	K	L	M
30	24	0.375	0.625	2.5	5 C	2	5 C	1	12.804	0.401	9.904

N	P	Q	R	S	T	U	V	W	X	Y
3.404	3.5	3.351	10.254	3	2.986	10.919	7.5	5.5	5 D	1.5

COLORS: LEGEND, BORDER – BLACK  
BACKGROUND – WHITE (RETROREFLECTIVE)



R3-19b

LANE FOR U AND LEFT TURNS ONLY

- \* Increase Spacing 5%.
- \*\* Reduce Spacing 20%.
- \*\*\* See page 7-3 for arrow design.

A	B	C	D	E	F	G	H	J
30	0.375	0.5	2.875	4.5 C	2	4.5 C*	4.5 C**	2.25

K	L	M	N	P	Q	R	S	T
1	4.5 D	11.885	3	8.913	3.063	3.5	1.531	8.093

U	V	W	X	Y	Z	AA	BB	CC
10.517	1.75	1.317	13.584	2.253	10.262	7.5	5.5	1.875

COLORS: LEGEND, BORDER – BLACK  
BACKGROUND – WHITE (RETROREFLECTIVE)

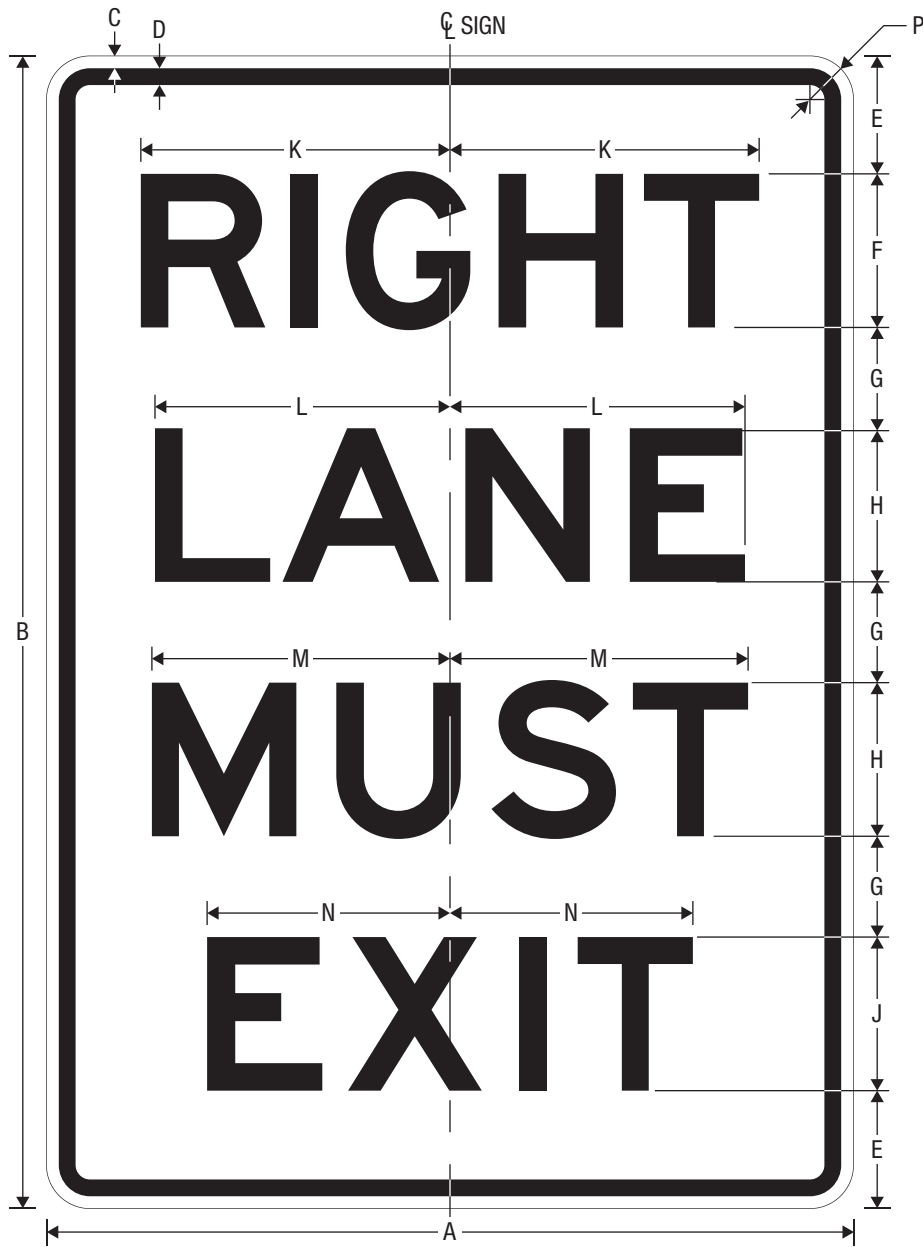

R3-33aR  
RIGHT LANE MUST EXIT

\* Decrease Spacing 20%.  
\*\* Increase Spacing 20%.

A	B	C	D	E	F	G	H	J	K	L	M	N	P
42	60	0.625	0.875	6.125	8 E*	5.25	8 E	8 E**	16.102	15.365	15.526	12.650	2.25

COLORS: LEGEND, BORDER – BLACK  
BACKGROUND – WHITE (RETROREFLECTIVE)

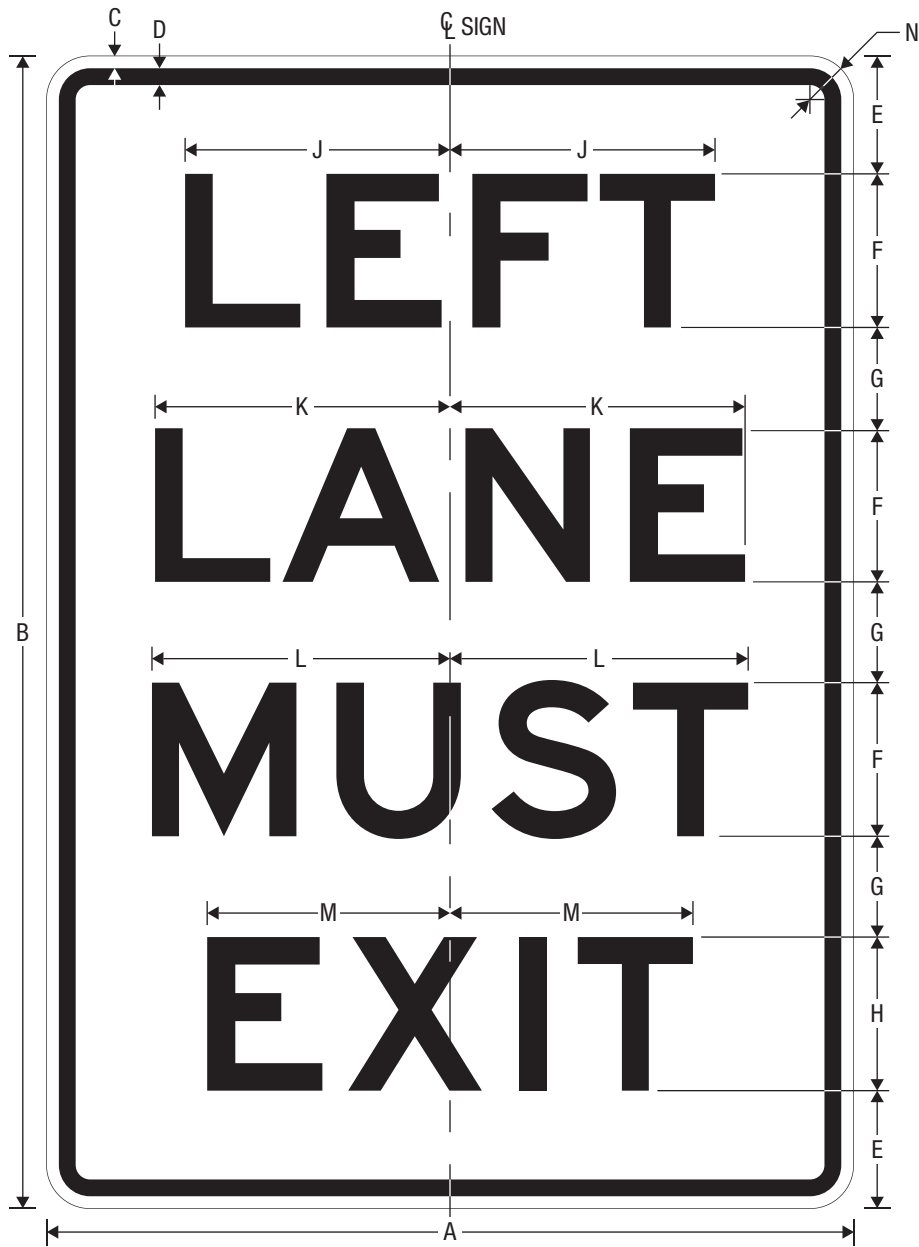

R3-33aL  
LEFT LANE MUST EXIT

\* Increase Spacing 20%.

A	B	C	D	E	F	G	H	J	K	L	M	N
42	60	0.625	0.875	6.125	8 E	5.25	8 E*	13.800	15.365	15.526	12.650	2.25

COLORS: LEGEND, BORDER – BLACK  
BACKGROUND – WHITE (RETROREFLECTIVE)



R3-44b

PRICED MANAGED LANE OPERATION (OVERHEAD)

\* Increase Spacing 30%.

\*\* See page 7-5 for arrow design.

A	B	C	D	E	F	G	H	J	K	L	M	N	P
90	72	0.75	1.25	10	10 E*	8	7.5	34.498	34.497	20.814	12	16.5	9

COLORS: LEGEND, BORDER – BLACK  
BACKGROUND – WHITE (RETROREFLECTIVE)





R3-51

PART-TIME TRAVEL ON SHOULDER OPERATION

\* Reduce Spacing 20%.

A	B	C	D	E	F	G	H	J	K	L	M	N
66	78	0.75	1.25	7.5	10 C*	6	10 C	6 D	4	6.5	28.210	10.105

P	Q	R	S	T	U	V	W	X	Y	Z	AA	BB
5	13.105	28.560	24.560	VAR	VAR	3	3	VAR	VAR	VAR	VAR	3

COLORS: LEGEND, BORDER — BLACK  
BACKGROUND — WHITE (RETROREFLECTIVE)

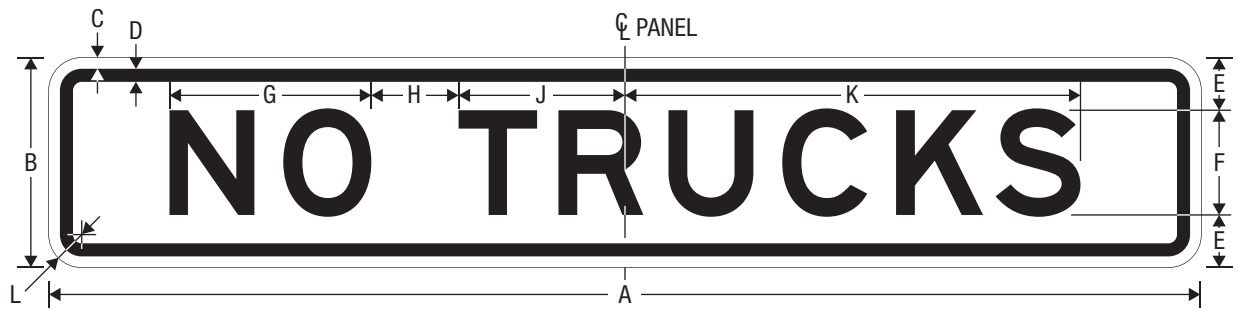

R3-51aP  
NO TRUCKS (PLAQUE)

\* Increase Spacing 20%.

A	B	C	D	E	F	G	H	J	K	L
66	12	0.625	0.75	3	6 E*	11.562	5	9.535	26.096	1.875

COLORS: LEGEND, BORDER — BLACK  
BACKGROUND — WHITE (RETROREFLECTIVE)

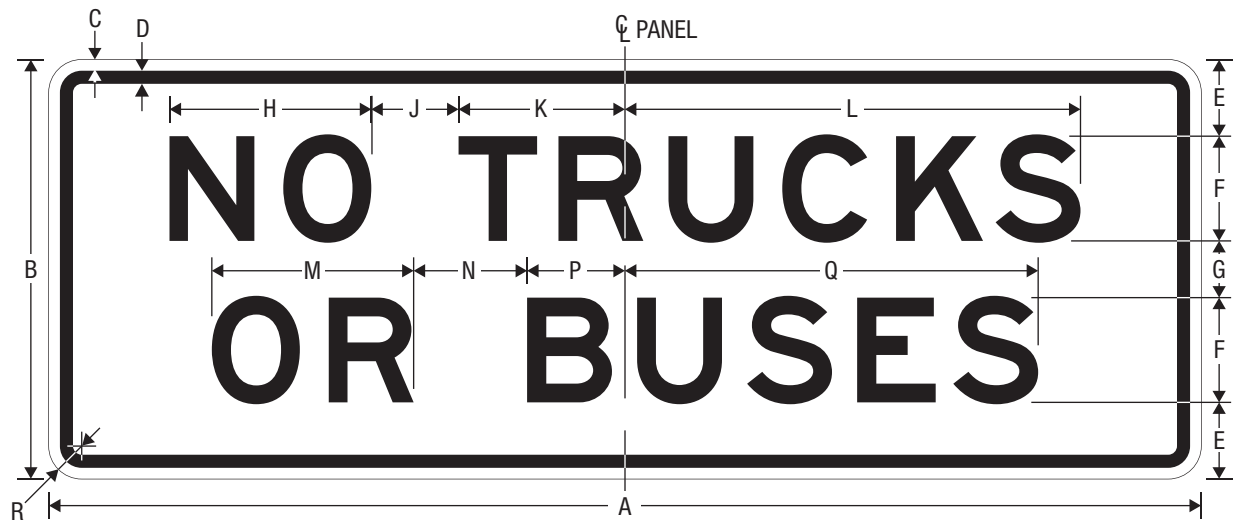

R3-51bP  
NO TRUCKS OR BUSES (PLAQUE)

\* Increase Spacing 20%.

A	B	C	D	E	F	G	H	J	K	L	M	N	P	Q	R
66	24	0.625	0.75	4.375	6 E*	3.25	11.562	5	9.535	26.096	11.562	6.5	5.609	23.671	1.875

COLORS: LEGEND, BORDER — BLACK  
BACKGROUND — WHITE (RETROREFLECTIVE)



R3-51cP

EMERGENCY STOPPING ONLY OTHER TIMES (PLAQUE)

\* Reduce Spacing 20%.

A	B	C	D	E	F	G	H	J	K
54	42	0.625	0.875	4.75	6 D*	3.5	6 D	5 D	3.75

L	M	N	P	Q	R	S	T	U	V
22.203	22.202	18.254	18.253	10.176	20.013	1.473	3.527	17.959	2.25

COLORS: LEGEND, BORDER — BLACK  
BACKGROUND — WHITE (RETROREFLECTIVE)



R3-51d

PART-TIME TRAVEL ON SHOULDER VARIABLE OPERATION

\* Reduce Spacing 20%.

A	B	C	D	E	F	G	H	J
66	84	0.75	1.25	7	10 C*	5	10 C	28.210

K	L	M	N	P	Q	R	S
10.105	13.105	28.560	24.560	14.607	14.606	25.709	3

COLORS: LEGEND, BORDER — BLACK  
BACKGROUND — WHITE (RETROREFLECTIVE)



R3-51e

PART-TIME TRAVEL ON SHOULDER ON GREEN ARROW

\* Reduce Spacing 20%.

A	B	C	D	E	F	G	H	J	K
66	84	0.75	0.125	7	10 C*	5	10 C	28.207	10.108

L	M	N	P	Q	R	S	T	U	V
13.105	28.560	13.505	8	6.304	27.809	18.458	18.457	13.905	3

COLORS: LEGEND, BORDER — BLACK  
BACKGROUND — WHITE (RETROREFLECTIVE)

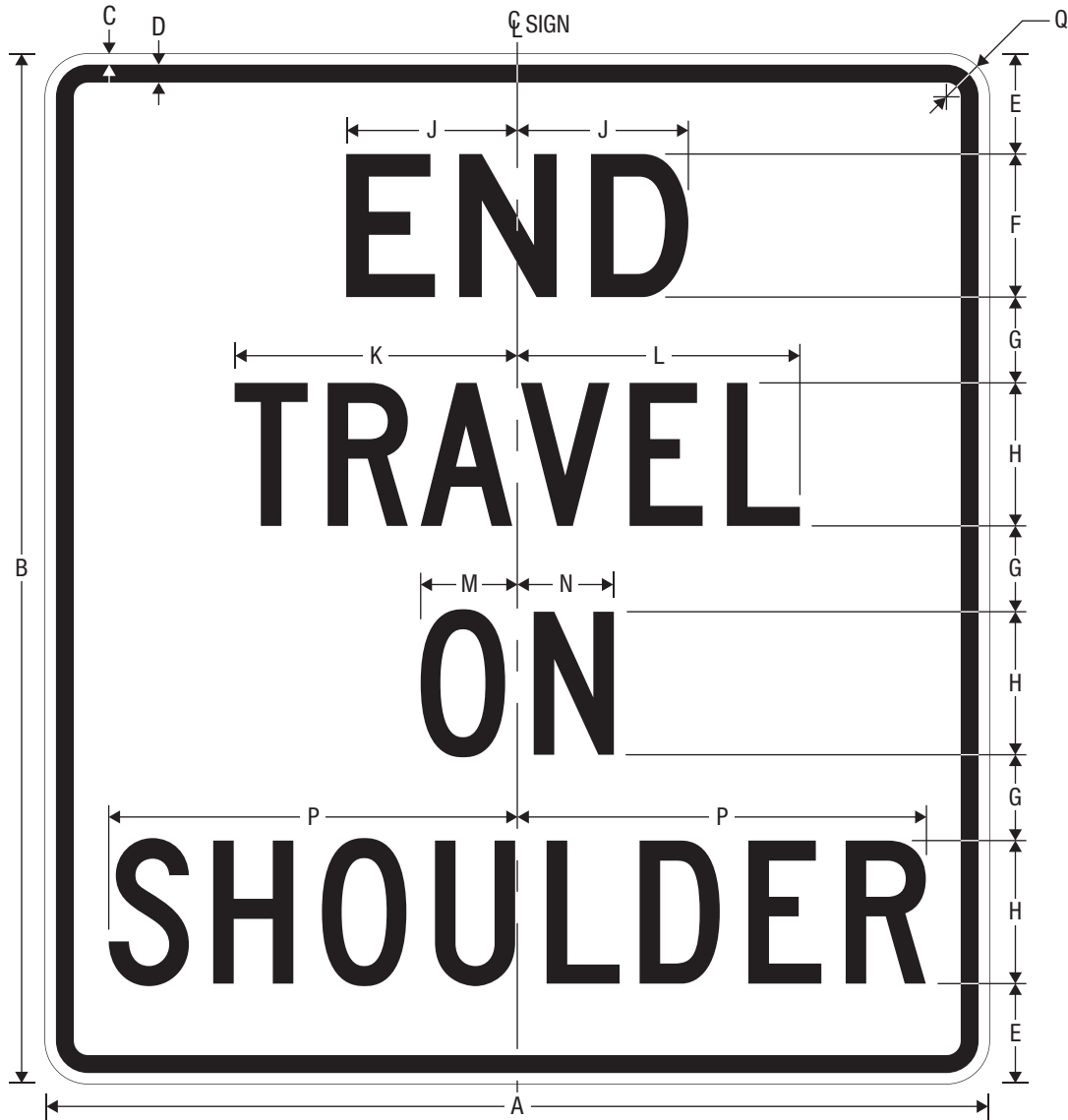

R3-52

PART-TIME TRAVEL ON SHOULDER ENDS

A	B	C	D	E	F	G	H
66	72	0.75	0.125	7	10 D	6	10 C

J	K	L	M	N	P	Q
11.959	19.758	19.757	6.753	6.752	28.560	3

COLORS: LEGEND, BORDER — BLACK  
BACKGROUND — WHITE (RETROREFLECTIVE)



R3-52a

PART-TIME TRAVEL ON SHOULDER ENDS ADVANCE

\* Reduce Spacing 20%.

A	B	C	D	E	F	G	H	J	K	L
66	72	0.75	0.125	6.75	10 C*	6	10 C	7.25	4.75	15

M	N	P	Q	R	S	T	U	V	W
28.210	10.105	5	13.105	28.560	13.655	VAR	8	24.010	3

COLORS: LEGEND, BORDER — BLACK  
BACKGROUND — WHITE (RETROREFLECTIVE)



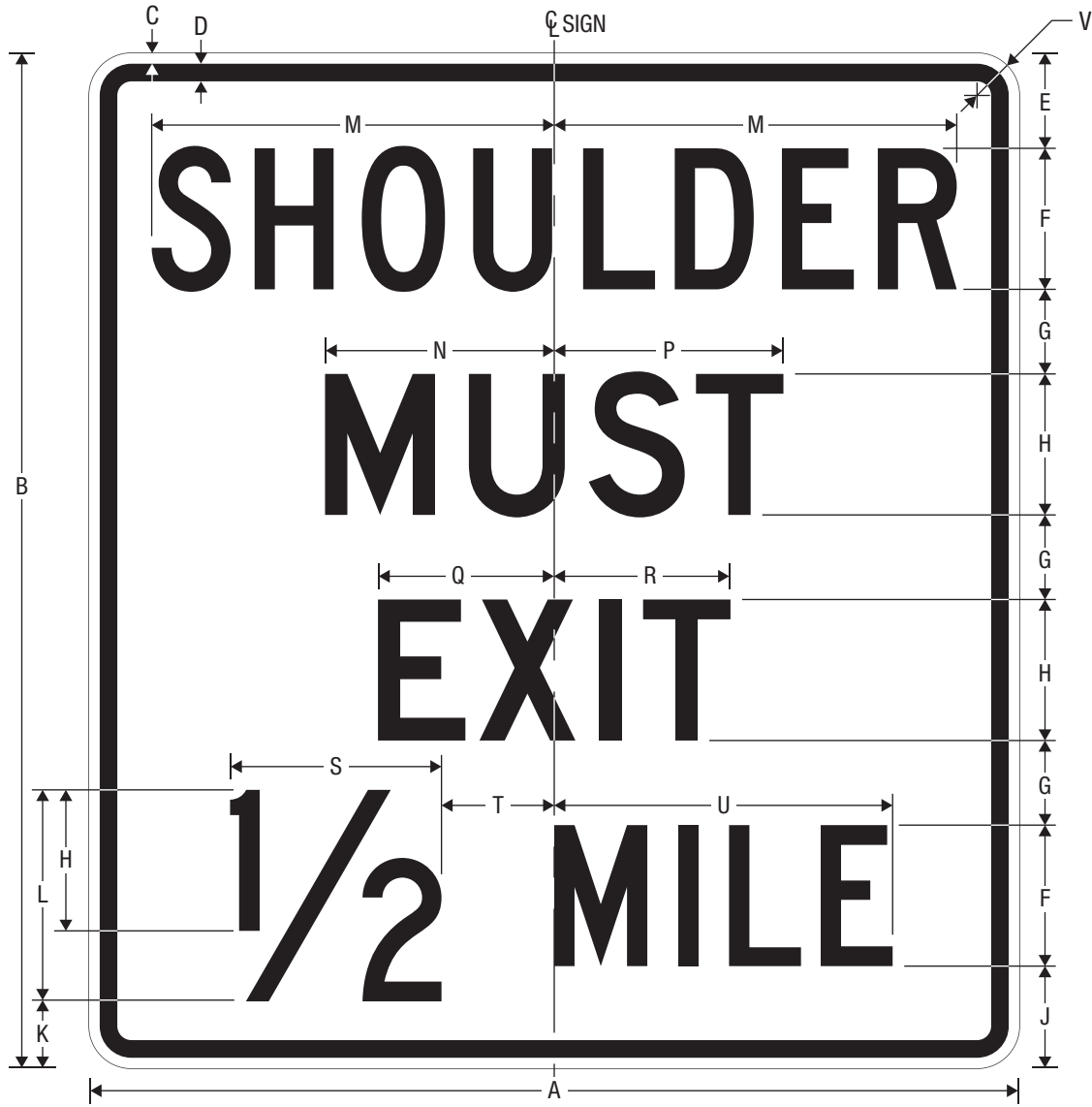

R3-52b  
SHOULDER MUST EXIT ADVANCE

\* Reduce Spacing 20%.

A	B	C	D	E	F	G	H	J	K
66	72	0.75	0.125	6.75	10 C	6	10 D	7.25	4.75
L	M	N	P	Q	R	S	T	U	V
15	28.560	16.262	16.261	12.507	12.506	VAR	8	24.010	3

COLORS: LEGEND, BORDER — BLACK  
BACKGROUND — WHITE (RETROREFLECTIVE)



R3-52c

PART-TIME TRAVEL ON SHOULDER BEGINS ADVANCE

\* Reduce Spacing 20%.

A	B	C	D	E	F	G	H	J	K	L
66	72	0.75	1.25	6.75	10 C*	6	10 C	7.25	4.75	15

M	N	P	Q	R	S	T	U	V	W	X
28.210	10.105	5	13.105	28.560	19.007	19.006	VAR	8	24.010	3

COLORS: LEGEND, BORDER — BLACK  
BACKGROUND — WHITE (RETROREFLECTIVE)



R3-56R  
BEGIN EXIT LANE



R3-56L  
BEGIN EXIT LANE

\* See page 7-3 for arrow design.

\*\* Increase Spacing 25%.

A	B	C	D	E	F	G	H	J
48	72	0.75	1.25	7	10 D	5.5	10 D**	4.889

K	L	M	N	P	Q	R	S	T
18.013	18.012	13.032	13.031	16.109	12.734	13	28	3

COLORS: LEGEND, BORDER — BLACK  
BACKGROUND — WHITE (RETROREFLECTIVE)

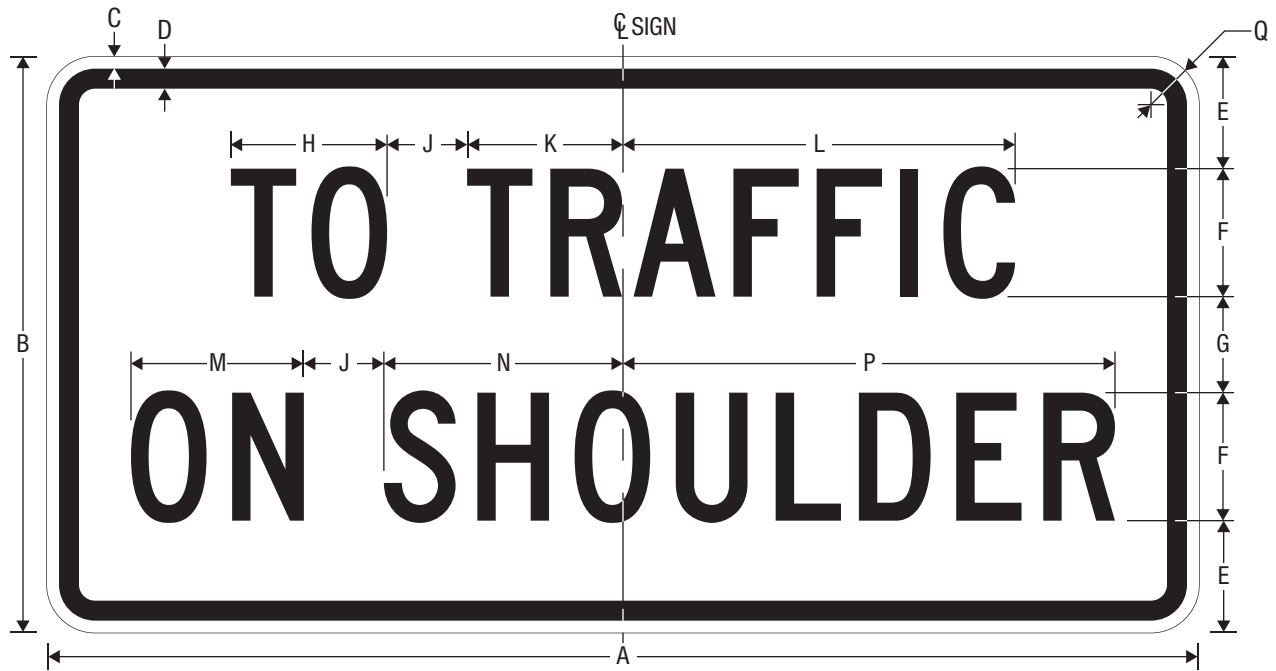

R3-57P

TO TRAFFIC ON SHOULDER (PLAQUE)

A	B	C	D	E	F	G	H	J	K	L	M	N	P	Q
36	18	0.375	0.625	3.5	4 C	3	4.882	2.5	4.872	12.254	5.402	7.473	15.375	1.5

COLORS: LEGEND, BORDER — BLACK  
BACKGROUND — WHITE (RETROREFLECTIVE)

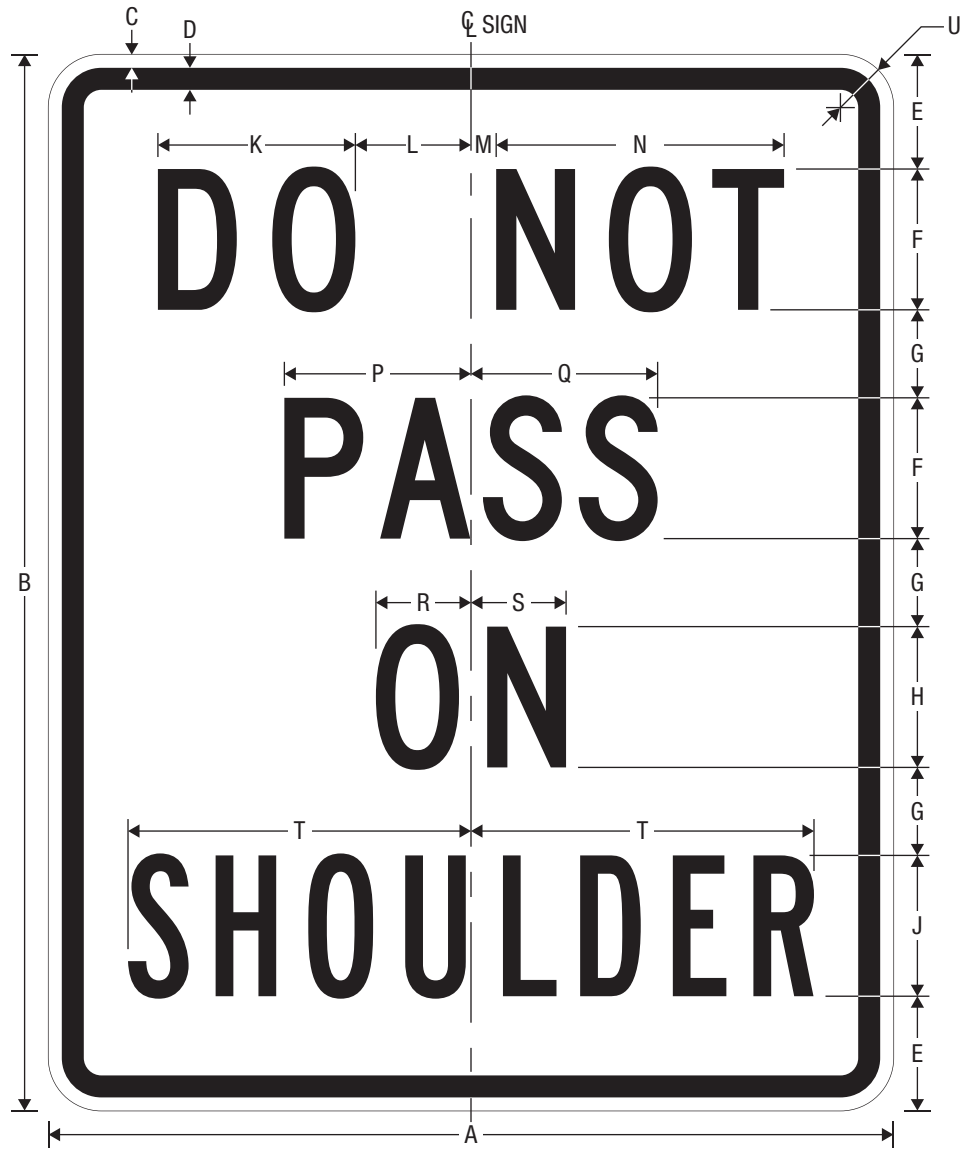

R4-18  
DO NOT PASS ON SHOULDER

\* Increase Spacing 40%.

\*\* Increase Spacing 20%.

A	B	C	D	E	F	G	H	J	K
18	24	0.375	0.625	3	3 C	2	3 C	3 B**	4.208*
24	30	0.375	0.625	3.25	4 C	2.5	4 C	4 B**	5.610*
36	48	0.625	0.875	6	6 C	4	6 C	6 B**	8.415*
48	60	0.75	1.25	7.5	8 C	5	7 C	7 C	11.220*

L	M	N	P	Q	R	S	T	U
2.463	0.537	6.134**	3.977	3.976	2.026	2.026	7.308	1.5
3.284	0.716	8.179**	5.302	5.302	2.701	2.701	9.744	1.5
4.927	1.073	12.269**	7.953	7.953	4.052	4.051	14.616	2.25
6.069	0.931	16.358**	10.604	10.604	4.727	4.727	19.992	3

COLORS: LEGEND, BORDER — BLACK  
BACKGROUND — WHITE (RETROREFLECTIVE)



R4-19

BICYCLE PASSING CLEARANCE

\* See page 8-4 for symbol design.

A	B	C	D	E	F	G	H	J	K	L	M
30	0.5	0.75	2.75	3.5 D	2.125	3.5 C	7.5	2.875	VAR	VAR	2.5

N	P	Q	R	S	T	U	V	W	X	Y	Z
4.552	0.202	2.298	7.354	10.942	10.941	4.272	1.254	8.025	6.563	6.562	1.875

COLORS: LEGEND, BORDER – BLACK  
BACKGROUND – WHITE (RETROREFLECTIVE)



R4-20R

ALL TRAFFIC

\* Increase Spacing 20%.

\*\* Reduce Spacing 20%.

\*\*\* See page 7-3 for arrow design.



R4-20L

A	B	C	D	E	F	G	H
24	30	0.375	0.625	4.25	5 C*	3.75	5 C**
36	48	0.625	0.875	6.25	7.5 C*	6.125	7.5 C**
48	60	0.75	1.25	8.5	10 C*	7.5	10 C**

J	K	L	M	N	P	Q	R
2.75	6.5	2.75	4.992	10.279	10.279	6	1.5
5.125	9.75	5.75	7.488	15.418	15.418	9	2.25
5.5	13	5.5	9.984	20.558	20.557	12	3

COLORS: LEGEND, BORDER — BLACK  
BACKGROUND — WHITE (RETROREFLECTIVE)

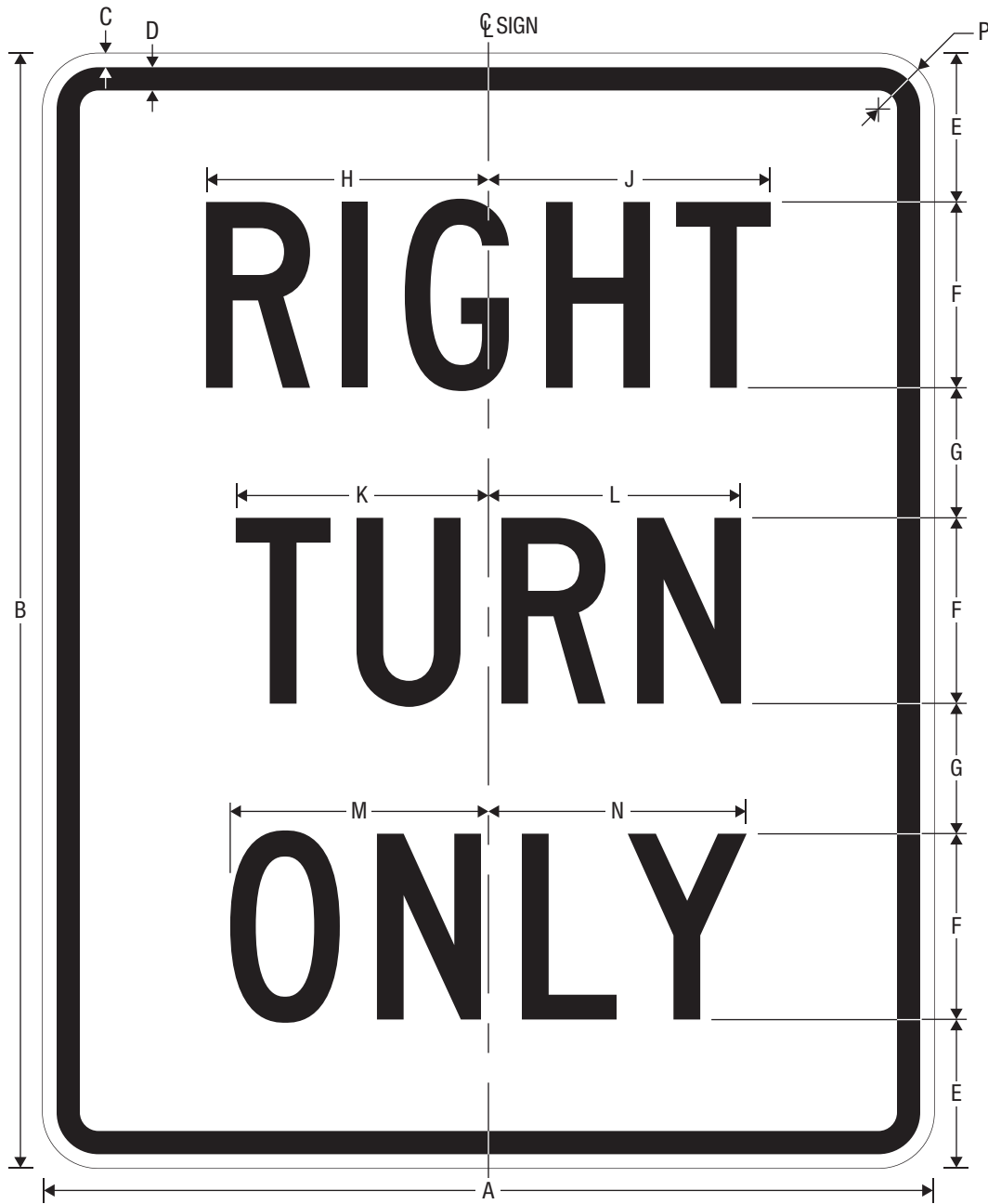

R4-21R  
RIGHT TURN ONLY

A	B	C	D	E	F	G	H	J	K	L	M	N	P
24	30	0.375	0.625	4	5 C	3.5	7.603	7.602	6.803	6.802	6.953	6.952	1.5

COLORS: LEGEND, BORDER — BLACK  
BACKGROUND — WHITE (RETROREFLECTIVE)

2-189-1



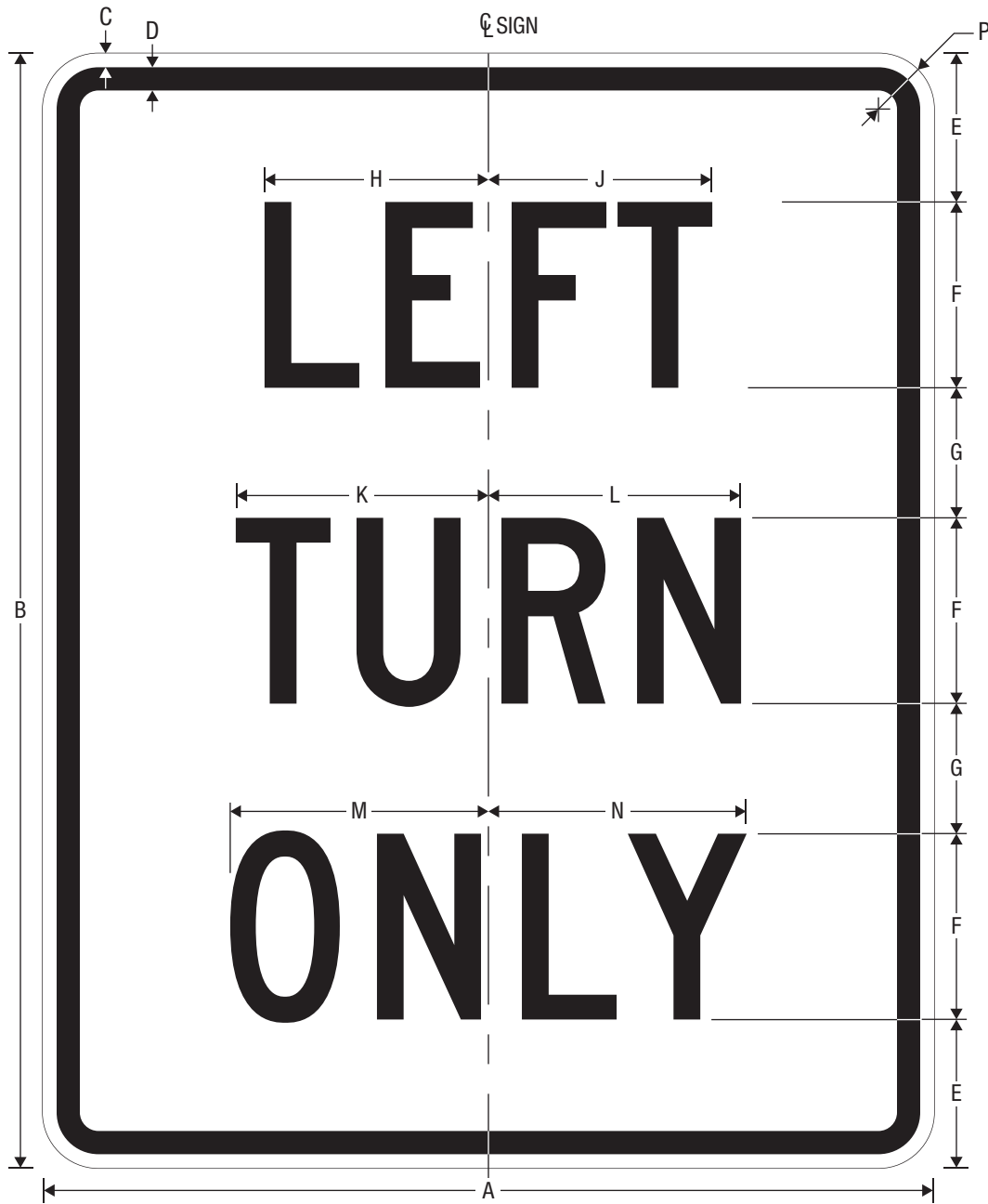

R4-21L  
LEFT TURN ONLY

A	B	C	D	E	F	G	H	J	K	L	M	N	P
24	30	0.375	0.625	4	5 C	3.5	6.028	6.027	6.803	6.802	6.953	6.952	1.5

COLORS: LEGEND, BORDER — BLACK  
BACKGROUND — WHITE (RETROREFLECTIVE)

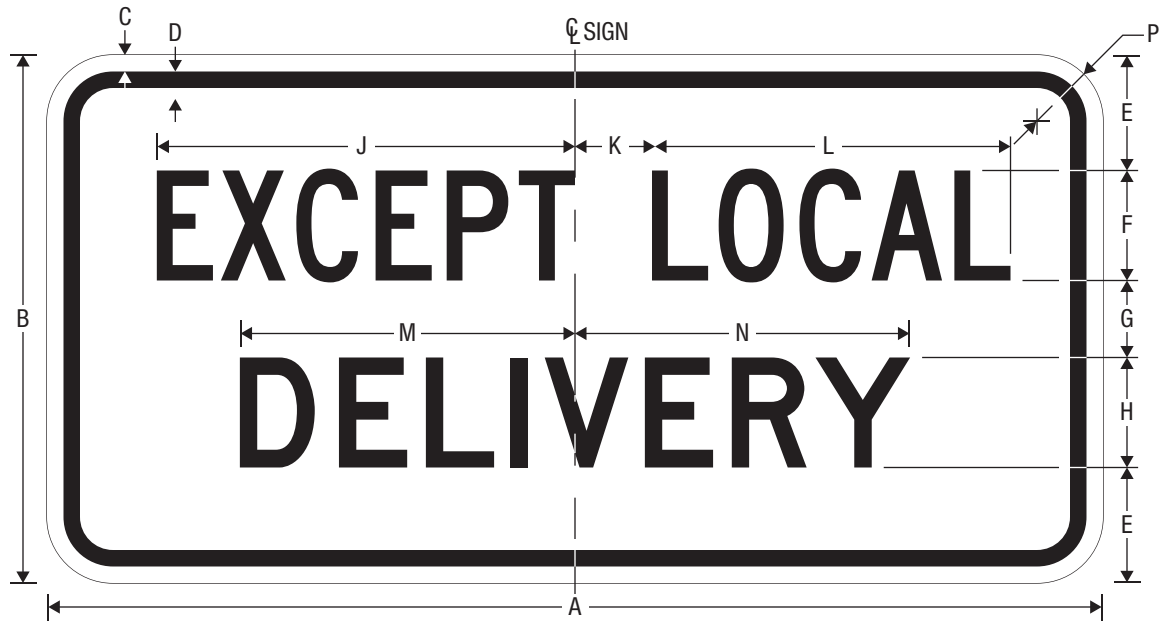

R5-2aP

EXCEPT LOCAL DELIVERY (PLAQUE)

\* Reduce Spacing 20%.

A	B	C	D	E	F	G	H	J	K	L	M	N	P
24	12	0.375	0.375	2.625	2.5 C*	1.75	2.5 D	9.504	1.75	8.148	7.617	7.616	1.5
30	15	0.375	0.5	3.125	3.25 C*	2.25	3.25 D	12.355	2.25	10.593	9.902	9.901	1.5
36	18	0.375	0.625	3.625	4 C*	2.75	4 D	15.206	2.375	13.037	12.187	12.186	1.5

COLORS: LEGEND, BORDER – BLACK  
BACKGROUND – WHITE (RETROREFLECTIVE)

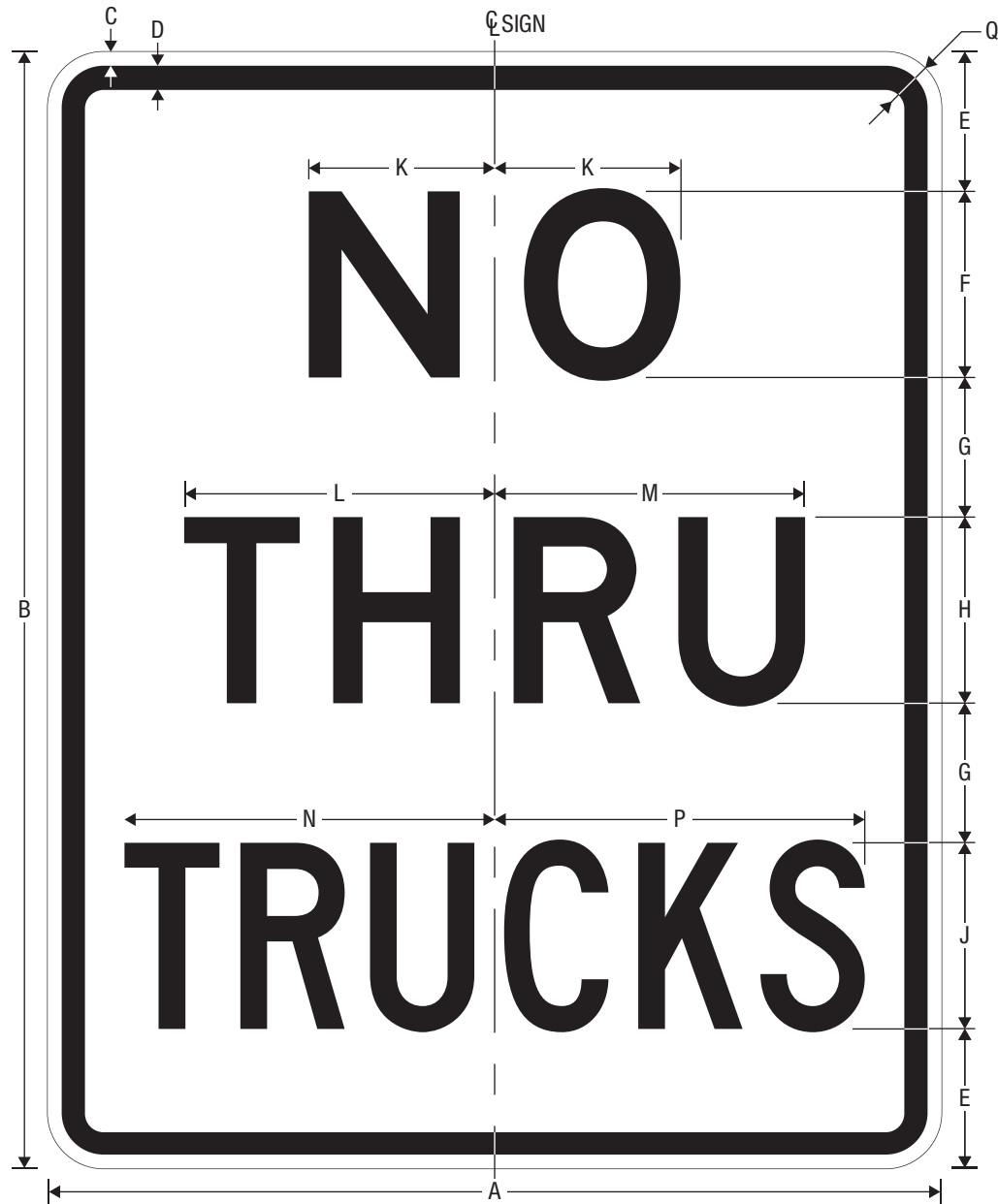

R5-2b  
NO THRU TRUCKS

- \* Increase Spacing 50%.
- \*\* Increase Spacing 20%.
- \*\*\* Reduce Spacing 20%.

A	B	C	D	E	F	G	H
24	30	0.375	0.625	3.75	5 E*	3.75	5 D**
30	36	0.5	0.75	4.5	6 E*	4.5	6 D**
36	48	0.625	0.875	7.25	7 E*	6.25	7 D**

J	K	L	M	N	P	Q
5 C***	4.990	8.337	8.336	9.939	9.939	1.5
6 C	5.988	10.004	10.003	12.425	12.424	1.875
7 C	6.986	11.671	11.671	14.496	14.495	2.25

COLORS: LEGEND, BORDER — BLACK  
BACKGROUND — WHITE (RETROREFLECTIVE)



R5-10a

NO PEDESTRIANS, BICYCLES,  
MOTOR-DRIVEN CYCLES ON FREEWAY

\* Increase Spacing 50%.  
\*\* Reduce Spacing 50%.

A	B	C	D	E	F	G	H	J	K	L	M	N	P	Q
30	36	0.5	0.75	3	3.5 E*	2.25	3.5 C	3.5 C**	1.75	2 D*	2.75	3.493	12.622	8.946

R	S	T	U	V	W	X	Y	Z	AA	BB	CC	DD	EE
8.945	11.310	0.375	1.165	0.585	0.5	11.764	7.073	7.072	3.443	2	3.457	8.899	1.875

COLORS: LEGEND, BORDER – BLACK  
BACKGROUND – WHITE (RETROREFLECTIVE)

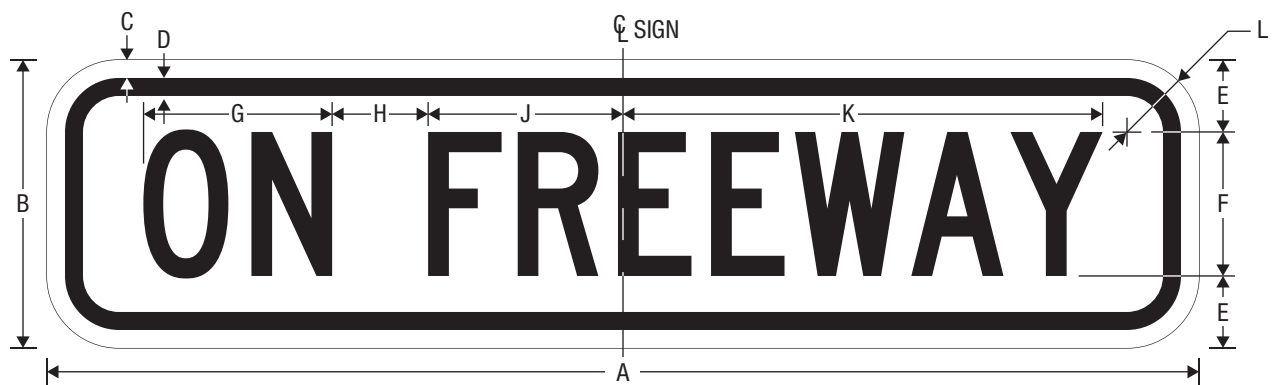

R5-10dP  
ON FREEWAY (PLAQUE)

\* Reduce Spacing 20%.

A	B	C	D	E	F	G	H	J	K	L
24	6	0.375	0.375	1.5	3 C*	3.932	2	4.060	9.992	1.5
30	9	0.375	0.625	2.625	3.75 C*	4.914	2.5	5.076	12.489	1.5

COLORS: LEGEND, BORDER — BLACK  
BACKGROUND — WHITE (RETROREFLECTIVE)

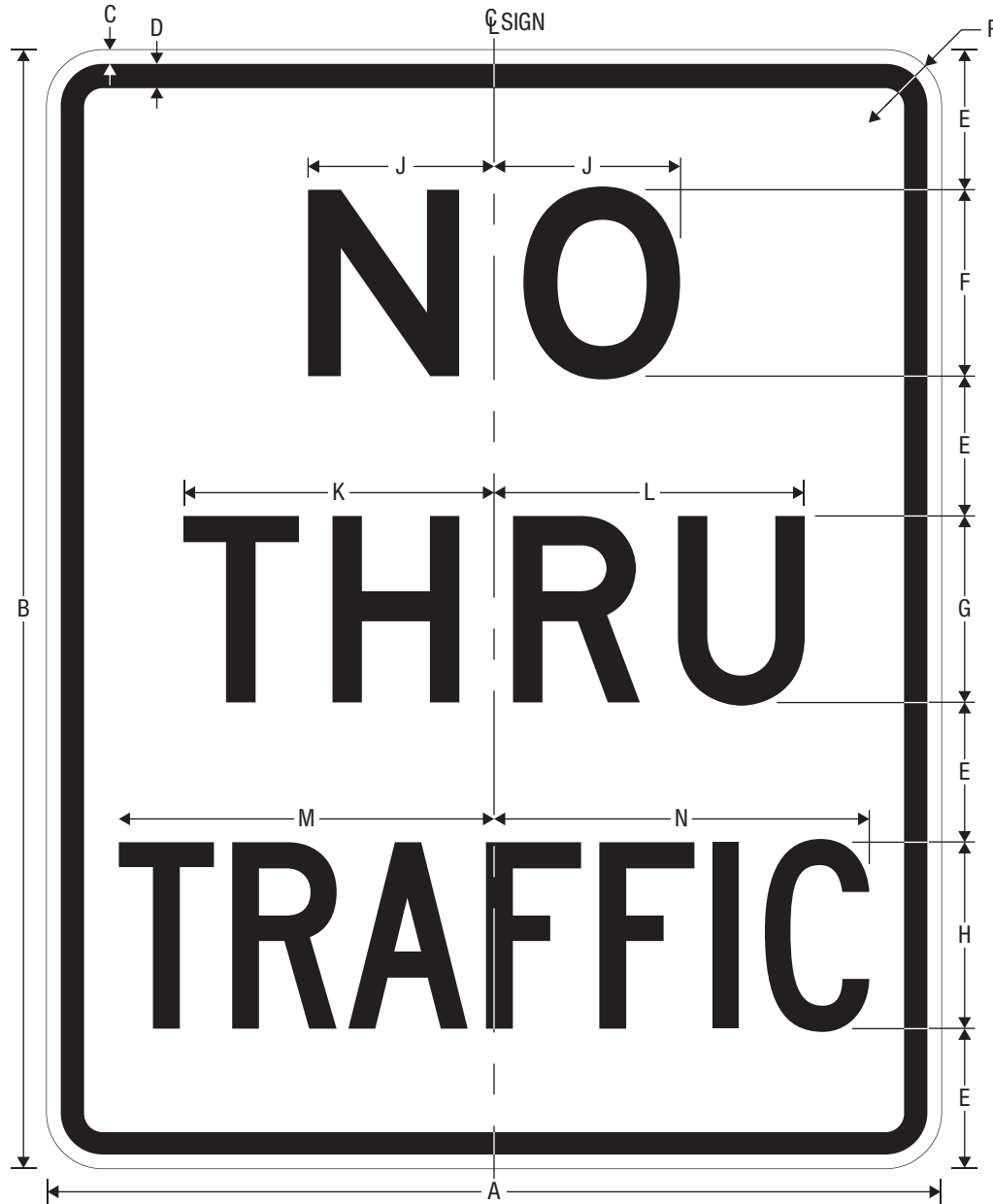

R5-12  
NO THRU TRAFFIC

- \* Increase Spacing 50%.
- \*\* Increase Spacing 20%.
- \*\*\* Reduce Spacing 30%.

A	B	C	D	E	F	G
24	30	0.375	0.625	3.75	5 E*	5 D**
30	36	0.5	0.75	4.5	6 E*	6 D**

H	J	K	L	M	N	P
5 C***	4.990	8.337	8.336	10.067	10.066	1.5
6 C	5.988	10.004	10.003	12.845	12.844	1.875

COLORS: LEGEND, BORDER — BLACK  
BACKGROUND — WHITE (RETROREFLECTIVE)

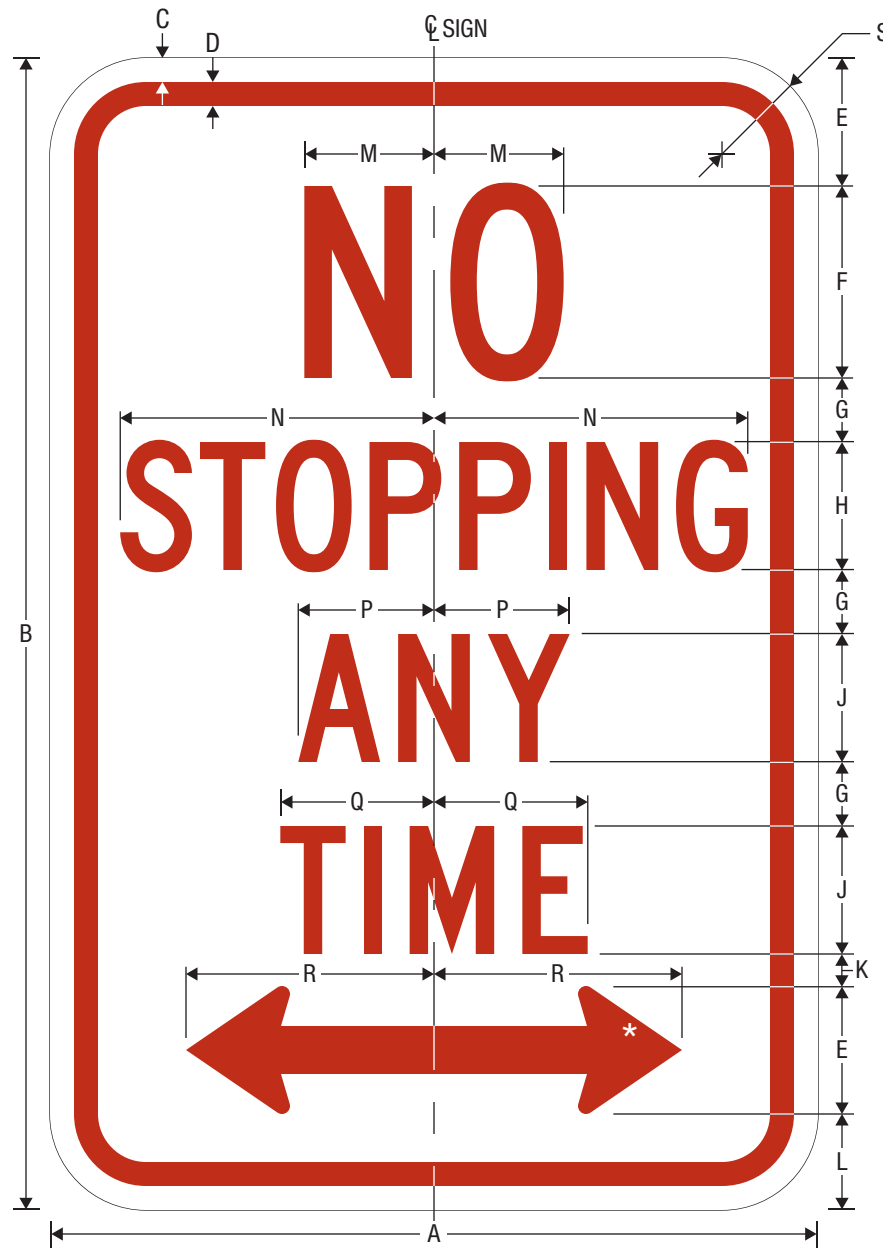

R7-4a  
NO STOPPING ANY TIME

\* See page 7-3 for arrow design.  
\*\* Reduce Spacing 30%.

A	B	C	D	E	F	G	H	J
12	18	0.375	0.375	2	3 C	1	2 C**	2 C

K	L	M	N	P	Q	R	S
0.5	1.5	2.026	4.903	2.121	2.401	3.875	1.5

COLORS: LEGEND, BORDER – RED (RETROREFLECTIVE)  
BACKGROUND – WHITE (RETROREFLECTIVE)



R7-10  
BACK-IN PARKING

\* See page 7-3 for arrow design.

A	B	C	D	E	F	G	H	J	K
12	18	0.375	0.375	3.5	2 C	1.5	2	0.75	4.526

L	M	N	P	Q	R	S	T	U	V
0.936	0.25	1	0.5	1.841	4.602	4.601	2.781	3.875	1.5

COLORS: LEGEND, BORDER – GREEN (RETROREFLECTIVE)  
BACKGROUND – WHITE (RETROREFLECTIVE)





R7-21aP  
MOBILE PARKING PAYMENT (PLAQUE)

- \* Reduce Spacing 50%.
- \*\* Increase Spacing 10%.
- \*\*\* Increase Spacing 20%.
- † Increase Spacing 100%.

A	B	C	D	E	F	G	H	J	K
12	6	0.25	0.25	0.75	1 C*	0.25	0.75 C**	0.375	0.75 D***
L	M	N	P	Q	R	S	T	U	V
0.313	1 E†	0.562	0.812	0.5 E	0.938	0.5 D	4.092	0.5	0.260
W	X	Y	Z	AA	BB	CC	DD	EE	FF
4.852	VAR	VAR	0.806	VAR	VAR	1.936	1	VAR	1.5

UPPER SECTION

COLORS: LEGEND, BORDER – GREEN (RETROREFLECTIVE)  
BACKGROUND – WHITE (RETROREFLECTIVE)

LOWER SECTION

COLORS: LEGEND, BORDER – WHITE (RETROREFLECTIVE)  
BACKGROUND – GREEN (RETROREFLECTIVE)

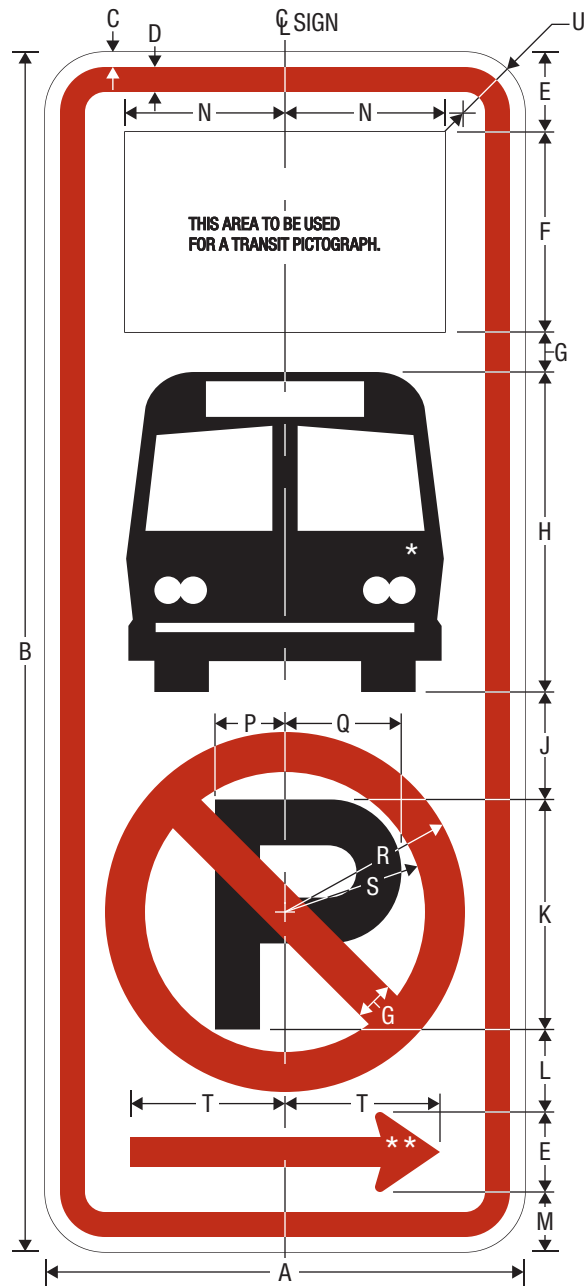

R7-107b

NO PARKING BUS STOP (WITH TRANSIT PICTOGRAPH)

\* See page 8-47 for symbol design.

\*\* See page 7-3 for arrow design.

A	B	C	D	E	F	G	H	J	K
12	30	0.375	0.625	2	5	1	8	2.688	5.75 E(m)

L	M	N	P	Q	R	S	T	U
2.062	1.5	4	1.75	2.910	4.5	3.5	3.875	1.5

COLORS: LEGEND, BORDER – RED (RETROREFLECTIVE)  
 BACKGROUND – WHITE (RETROREFLECTIVE)  
 SYMBOL – BLACK

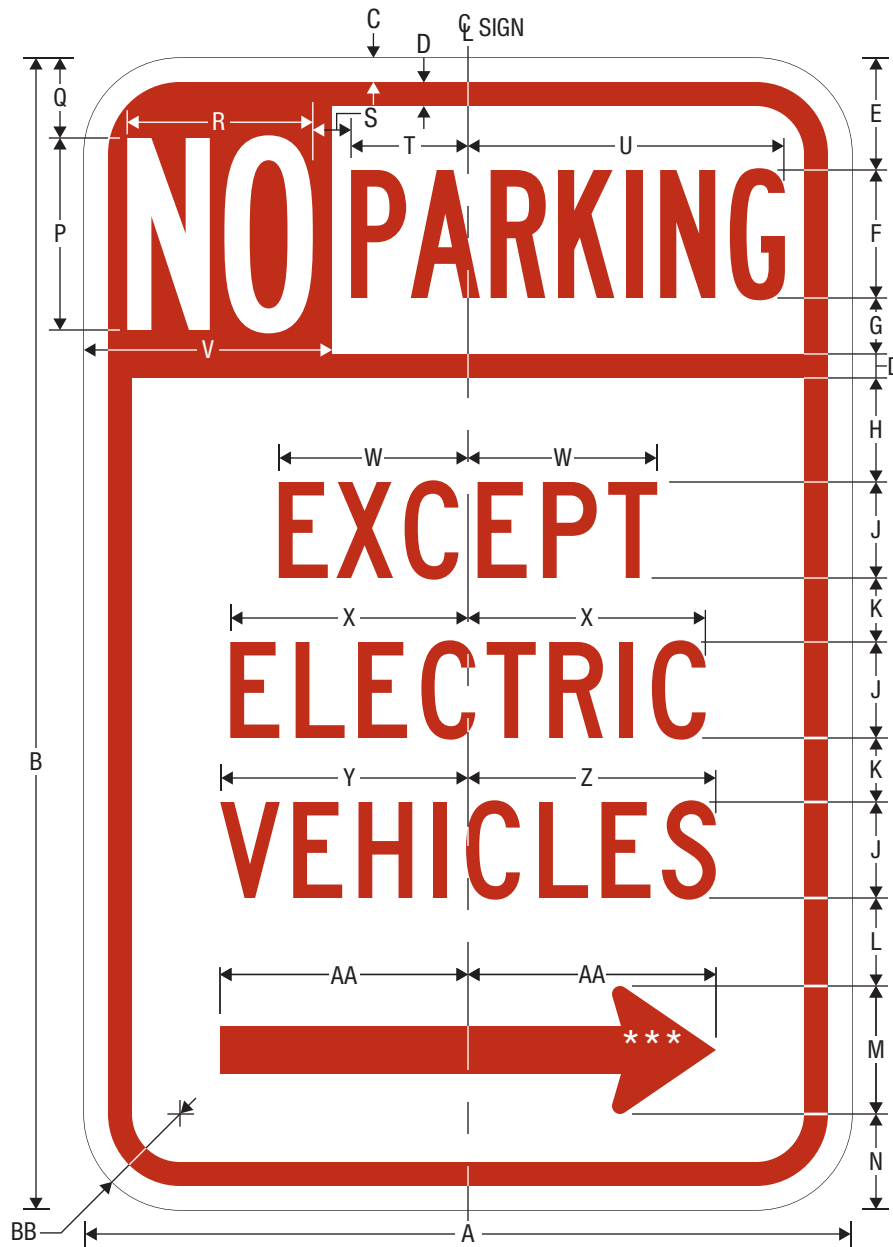

R7-111

NO PARKING EXCEPT ELECTRIC VEHICLES

- \* Reduce Spacing 40%.
- \*\* Reduce Spacing 60%.
- \*\*\* See page 7-3 for arrow design.

A	B	C	D	E	F	G	H	J	K	L	M	N
12	18	0.375	0.375	1.75	2 B*	0.875	1.625	1.5 C	1	1.375	2	1.5

P	Q	R	S	T	U	V	W	X	Y	Z	AA	BB
3 B**	1.25	2.900	0.300	1.827	4.952	3.875	2.956	3.714	3.872	3.871	3.875	1.5

UPPER LEFT SECTION

COLORS: LEGEND, BORDER — WHITE (RETROREFLECTIVE)  
BACKGROUND — RED (RETROREFLECTIVE)

REMAINDER OF SIGN

COLORS: LEGEND, BORDER — RED (RETROREFLECTIVE)  
BACKGROUND — WHITE (RETROREFLECTIVE)



R7-111a

NO PARKING EXCEPT ELECTRIC VEHICLES (PART-TIME)

- \* Reduce Spacing 40%.
- \*\* Reduce Spacing 60%.
- \*\*\* See page 7-3 for arrow design.

A	B	C	D	E	F	G	H	J	K	L	M	N	P	Q
12	18	0.375	0.375	1.75	2 B*	0.875	0.75	1.5 C	0.5	2	1.5	3 B**	1.25	2.900

R	S	T	U	V	W	X	Y	Z	AA	BB	CC	DD	EE	FF
0.300	1.827	4.952	3.875	VAR	VAR	0.5	0.75	VAR	2.956	3.714	3.872	3.871	3.875	1.5

UPPER LEFT SECTION

COLORS: LEGEND, BORDER — WHITE (RETROREFLECTIVE)  
BACKGROUND — RED (RETROREFLECTIVE)

REMAINDER OF SIGN

COLORS: LEGEND, BORDER — RED (RETROREFLECTIVE)  
BACKGROUND — WHITE (RETROREFLECTIVE)



R7-112

ELECTRIC VEHICLE PARKING (TIME LIMIT)

\* Reduce Spacing 40%.

\*\* See page 7-3 for arrow design.

A	B	C	D	E	F	G	H	J	K	L
12	18	0.375	0.375	1.25	2 C	0.75	2 B*	0.5	0.25	1

M	N	P	Q	R	S	T	U	V	W
1.5 C	0.75	0.75	2	1.5	4 C	1.625	VAR	VAR	0.222

X	Y	Z	AA	BB	CC	DD	EE	FF	GG
2.681	1.827	4.952	3.875	3.714	3.872	3.871	2.086	3.875	1.5

UPPER LEFT SECTION

COLORS: LEGEND, BORDER — WHITE (RETROREFLECTIVE)  
BACKGROUND — GREEN (RETROREFLECTIVE)

REMAINDER OF SIGN

COLORS: LEGEND, BORDER — GREEN (RETROREFLECTIVE)  
BACKGROUND — WHITE (RETROREFLECTIVE)



R7-112a

ELECTRIC VEHICLE PARKING (TIME LIMIT, PART-TIME)

\* Reduce Spacing 40%.

\*\* See page 7-3 for arrow design.

A	B	C	D	E	F	G	H	J	K	L	M
12	18	0.375	0.375	1.25	2 C	0.75	2 B*	0.5	0.25	0.375	1.5 C

N	P	Q	R	S	T	U	V	W	X	Y
1.5 B	2	1	4 C	1.625	VAR	VAR	0.222	2.681	1.827	4.952

Z	AA	BB	CC	DD	EE	FF	GG	HH	JJ	KK
3.875	3.714	3.872	3.871	2.086	VAR	VAR	0.5	0.75	3.875	1.5

UPPER LEFT SECTION

COLORS: LEGEND, BORDER — WHITE (RETROREFLECTIVE)  
BACKGROUND — GREEN (RETROREFLECTIVE)

REMAINDER OF SIGN

COLORS: LEGEND, BORDER — GREEN (RETROREFLECTIVE)  
BACKGROUND — WHITE (RETROREFLECTIVE)



R7-112b

ELECTRIC VEHICLE PARKING (TIME LIMIT, PART-TIME)

\* Reduce Spacing 40%.  
\*\* See page 7-3 for arrow design.

A	B	C	D	E	F	G	H	J	K	L	M
12	21	0.375	0.375	1.25	2 C	0.75	2 B*	0.5	0.25	0.75	1.5 C

N	P	Q	R	S	T	U	V	W	X	Y
1.5 B	2	1.5	4 C	1.625	VAR	VAR	0.222	2.681	1.827	4.952

Z	AA	BB	CC	DD	EE	FF	GG	HH	JJ	KK
3.875	3.714	3.872	3.871	2.086	VAR	VAR	0.5	0.75	3.875	0.5

UPPER LEFT SECTION

COLORS: LEGEND, BORDER — WHITE (RETROREFLECTIVE)  
BACKGROUND — GREEN (RETROREFLECTIVE)

REMAINDER OF SIGN

COLORS: LEGEND, BORDER — GREEN (RETROREFLECTIVE)  
BACKGROUND — WHITE (RETROREFLECTIVE)

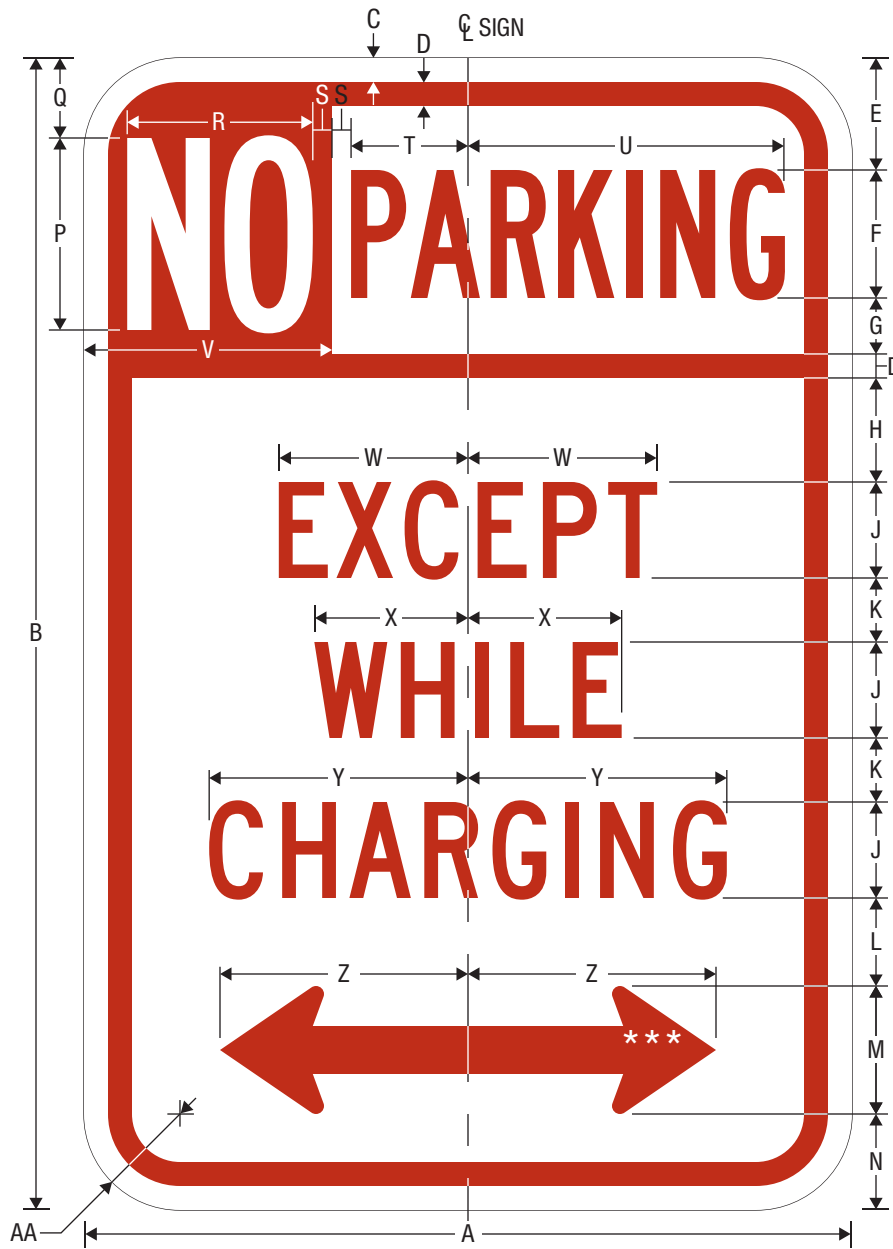

R7-113

NO PARKING EXCEPT WHILE CHARGING

- \* Reduce Spacing 40%.
- \*\* Reduce Spacing 60%.
- \*\*\* See page 7-3 for arrow design.

A	B	C	D	E	F	G	H	J	K	L	M	N
12	18	0.375	0.375	1.75	2 B*	0.875	1.625	1.5 C	1	1.375	2	1.5

P	Q	R	S	T	U	V	W	X	Y	Z	AA
3 B**	1.25	2.900	0.300	1.827	4.952	3.875	2.956	2.401	4.044	3.875	0.75

UPPER LEFT SECTION

COLORS: LEGEND, BORDER — WHITE (RETROREFLECTIVE)  
BACKGROUND — RED (RETROREFLECTIVE)

REMAINDER OF SIGN

COLORS: LEGEND, BORDER — RED (RETROREFLECTIVE)  
BACKGROUND — WHITE (RETROREFLECTIVE)



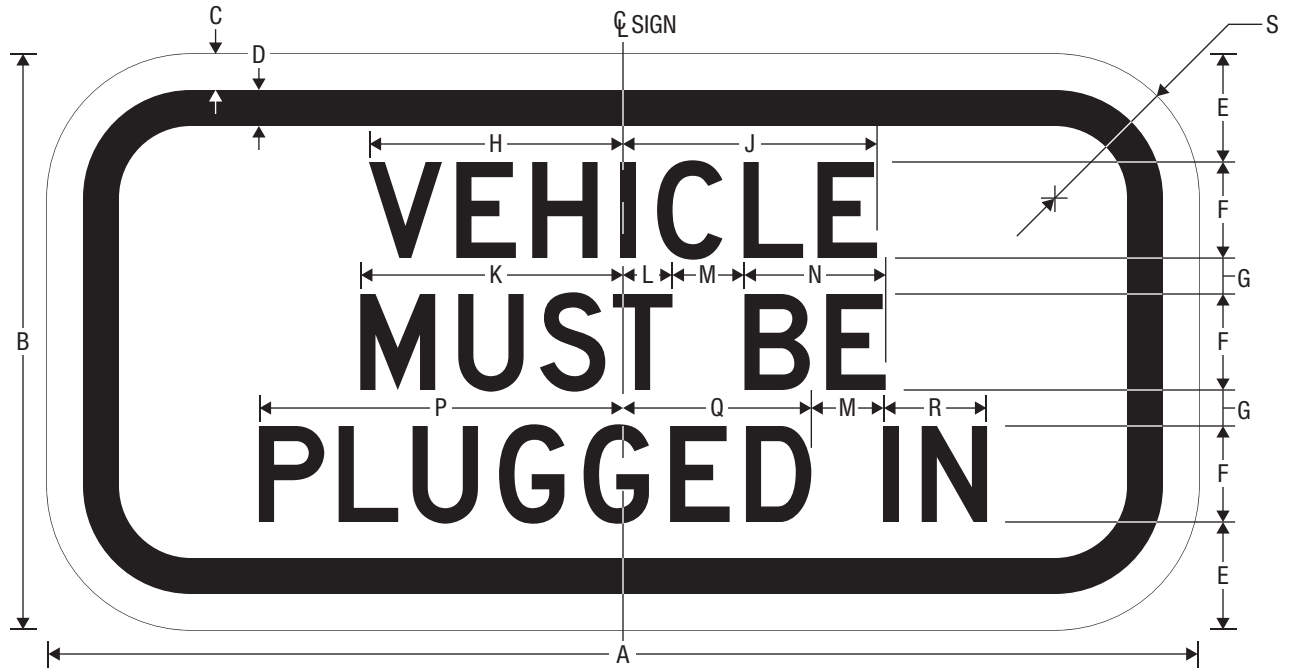

R7-113aP

VEHICLE MUST BE PLUGGED IN (PLAQUE)

A	B	C	D	E	F	G	H	J
12	6	0.375	0.375	1.125	1 D	0.375	2.647	2.646

K	L	M	N	P	Q	R	S
2.737	0.515	0.75	1.471	3.793	1.961	1.081	1.5

COLORS: LEGEND, BORDER – BLACK  
BACKGROUND – WHITE (RETROREFLECTIVE)

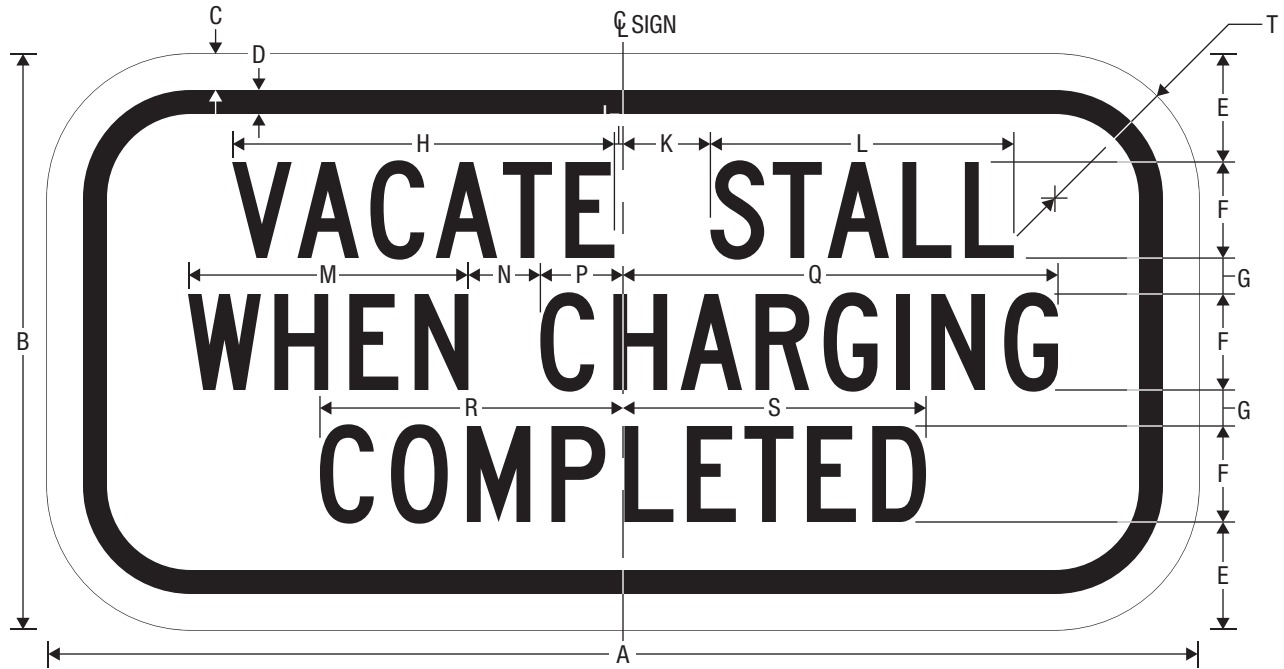

R7-113bP

VACATE STALL WHEN CHARGING COMPLETED (PLAQUE)

A	B	C	D	E	F	G	H	J
12	6	0.375	0.25	1.125	1 C	0.375	3.982	0.093

K	L	M	N	P	Q	R	S	T
0.907	3.161	2.921	0.75	0.860	4.532	3.157	3.156	1.5

COLORS: LEGEND, BORDER – BLACK  
BACKGROUND – WHITE (RETROREFLECTIVE)

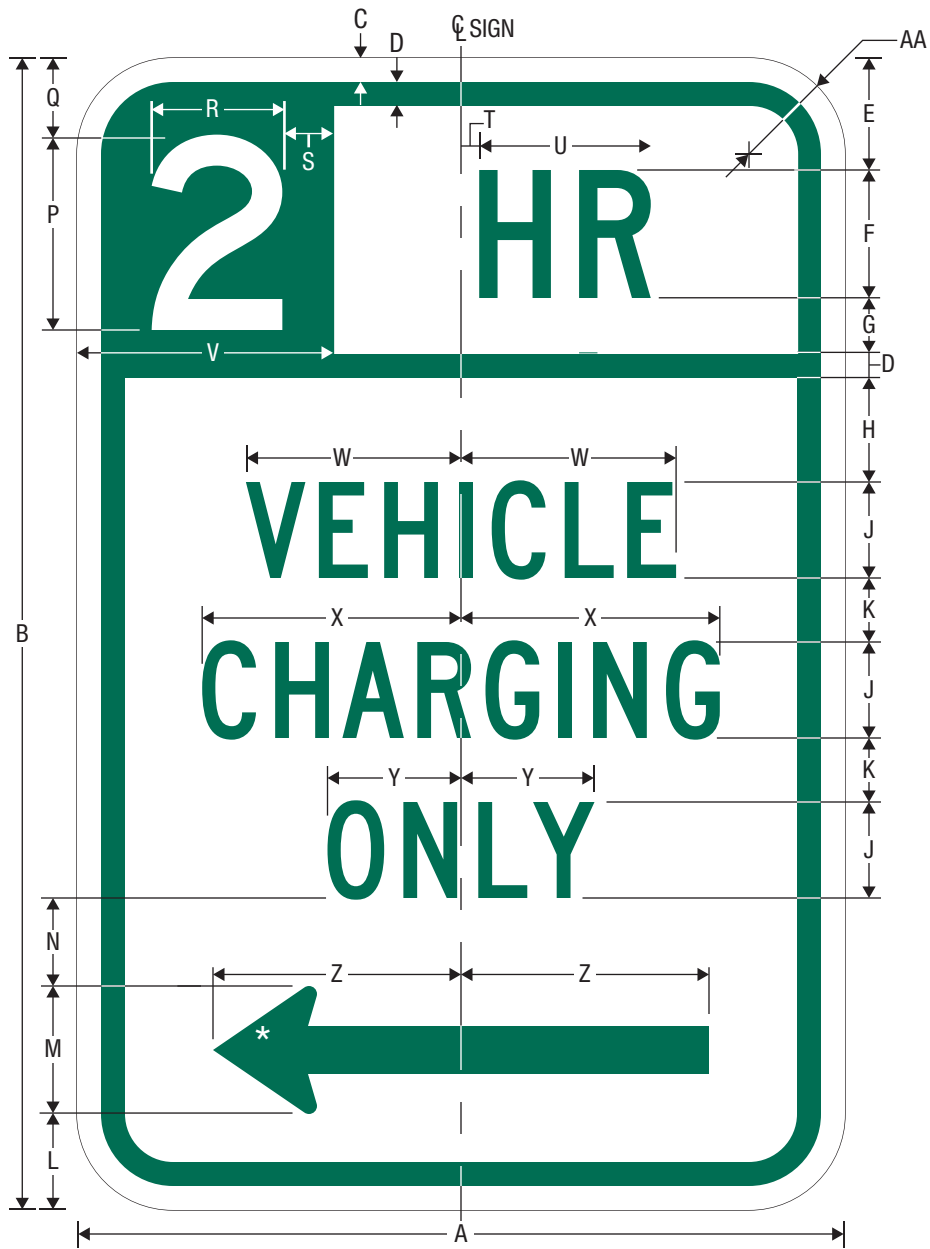

R7-114

VEHICLE CHARGING ONLY (TIME LIMIT)

\* See page 7-3 for arrow design.

A	B	C	D	E	F	G	H	J	K	L	M	N
12	18	0.375	0.375	1.75	2 C	0.875	1.625	1.5 C	1	1.5	2	1.375

P	Q	R	S	T	U	V	W	X	Y	Z	AA
3 D	1.25	VAR	VAR	0.284	2.681	4	3.361	4.044	2.086	3.875	1.5

UPPER LEFT SECTION

COLORS: LEGEND, BORDER — WHITE (RETROREFLECTIVE)  
BACKGROUND — GREEN (RETROREFLECTIVE)

REMAINDER OF SIGN

COLORS: LEGEND, BORDER — GREEN (RETROREFLECTIVE)  
BACKGROUND — WHITE (RETROREFLECTIVE)

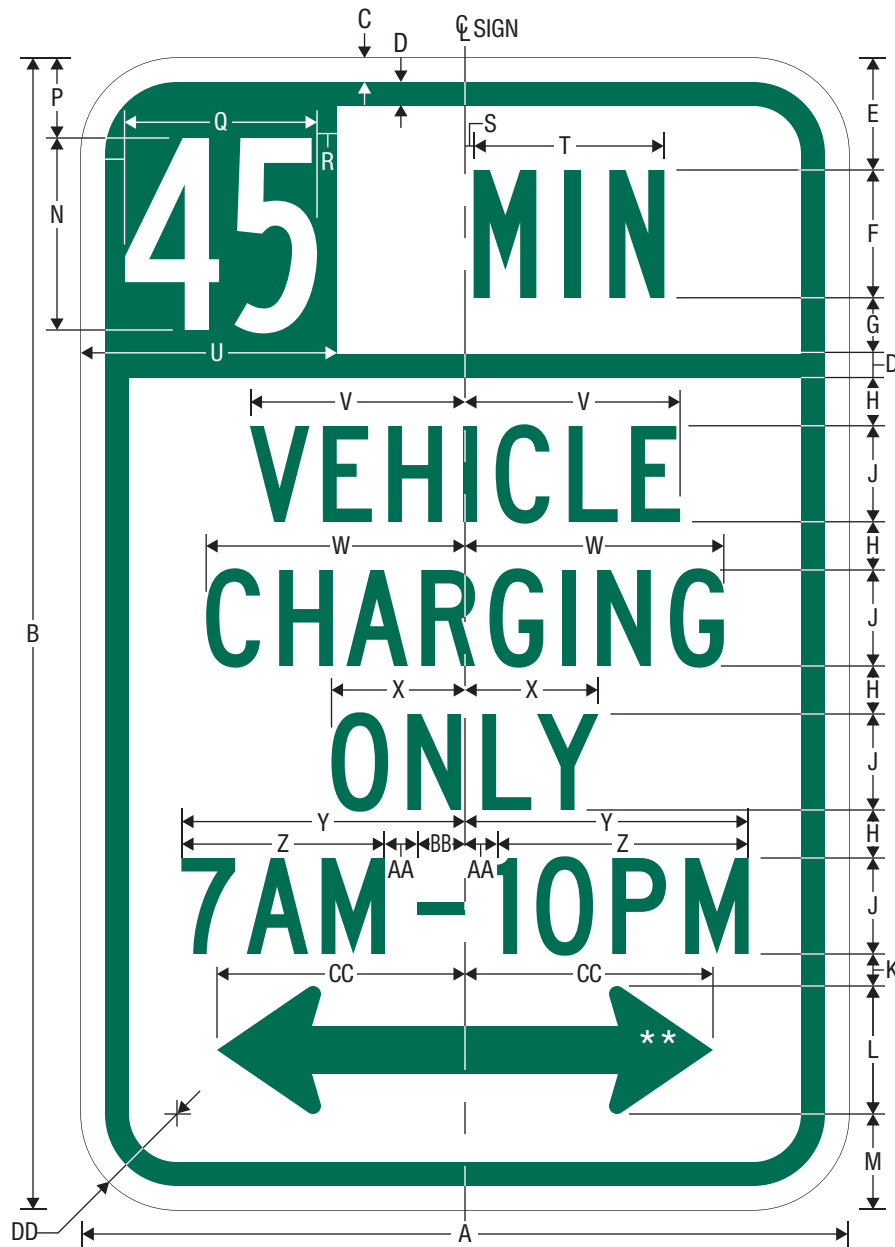

R7-114a

VEHICLE CHARGING ONLY (TIME LIMIT, PART-TIME)

\* Reduce Spacing 50%.

\*\* See page 7-3 for arrow design.

A	B	C	D	E	F	G	H	J	K	L	M	N	P
12	18	0.375	0.375	1.75	2 B	0.875	0.75	1.5 C	0.5	2	1.5	3 B*	1.25

Q	R	S	T	U	V	W	X	Y	Z	AA	BB	CC	DD
VAR	VAR	0.135	2.981	4	3.361	4.044	2.086	VAR	VAR	0.5	0.75	3.875	1.5

UPPER LEFT SECTION

COLORS: LEGEND, BORDER — WHITE (RETROREFLECTIVE)  
BACKGROUND — GREEN (RETROREFLECTIVE)

REMAINDER OF SIGN

COLORS: LEGEND, BORDER — GREEN (RETROREFLECTIVE)  
BACKGROUND — WHITE (RETROREFLECTIVE)

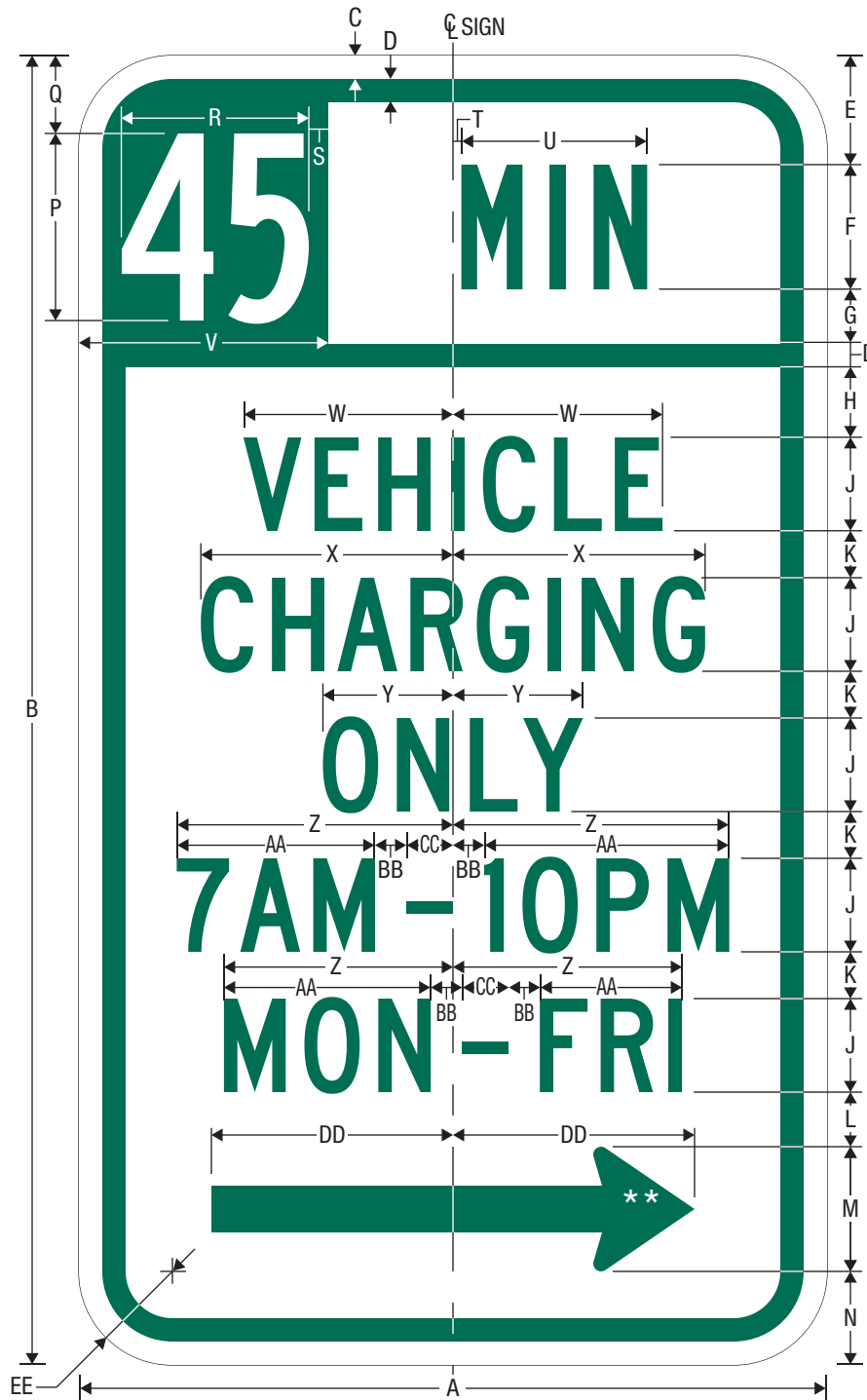

R7-114b

VEHICLE CHARGING ONLY (TIME LIMIT, PART-TIME)

\* Reduce Spacing 50%.

\*\* See page 7-3 for arrow design.

A	B	C	D	E	F	G	H	J	K	L	M	N	P	Q
12	21	0.375	0.375	1.75	2 B	0.875	1.125	1.5 C	0.75	0.875	2	1.5	3 B*	1.25

R	S	T	U	V	W	X	Y	Z	AA	BB	CC	DD	EE
VAR	VAR	0.135	2.981	4	3.361	4.044	2.086	VAR	VAR	0.5	0.75	3.875	1.5

UPPER LEFT SECTION

COLORS: LEGEND, BORDER — WHITE (RETROREFLECTIVE)  
BACKGROUND — GREEN (RETROREFLECTIVE)

REMAINDER OF SIGN

COLORS: LEGEND, BORDER — GREEN (RETROREFLECTIVE)  
BACKGROUND — WHITE (RETROREFLECTIVE)



R9-15  
NO SNOWMOBILES

\* See page 8-43 for symbol design.

A	B	C	D	E	F	G	H	J	K	L	M	N
18	0.375	0.625	3.125	5.875	2.625	6.375	5.800	5.799	6.375	7.875	1.5	1.5
24	0.375	0.625	4	8	3.5	8.5	7.847	7.846	8.5	10.5	2	1.5
30	0.5	0.75	5	10	4.375	10.625	9.808	9.808	10.625	13.125	2.5	1.875

COLORS: CIRCLE, DIAGONAL— RED (RETROREFLECTIVE)  
 SYMBOL, BORDER — BLACK  
 BACKGROUND — WHITE (RETROREFLECTIVE)



R9-16  
NO ALL-TERRAIN VEHICLES

\* See page 8-73 for symbol design.

A	B	C	D	E	F	G	H	J	K	L
18	0.375	0.625	4.125	4.875	3.125	5.875	6.375	7.875	1.5	1.5
24	0.375	0.625	5.375	6.625	4.125	7.875	8.5	10.5	2	1.5
30	0.5	0.75	6.75	8.25	5	10	10.625	13.125	2.5	1.875

COLORS: CIRCLE, DIAGONAL— RED (RETROREFLECTIVE)  
 SYMBOL, BORDER — BLACK  
 BACKGROUND — WHITE (RETROREFLECTIVE)

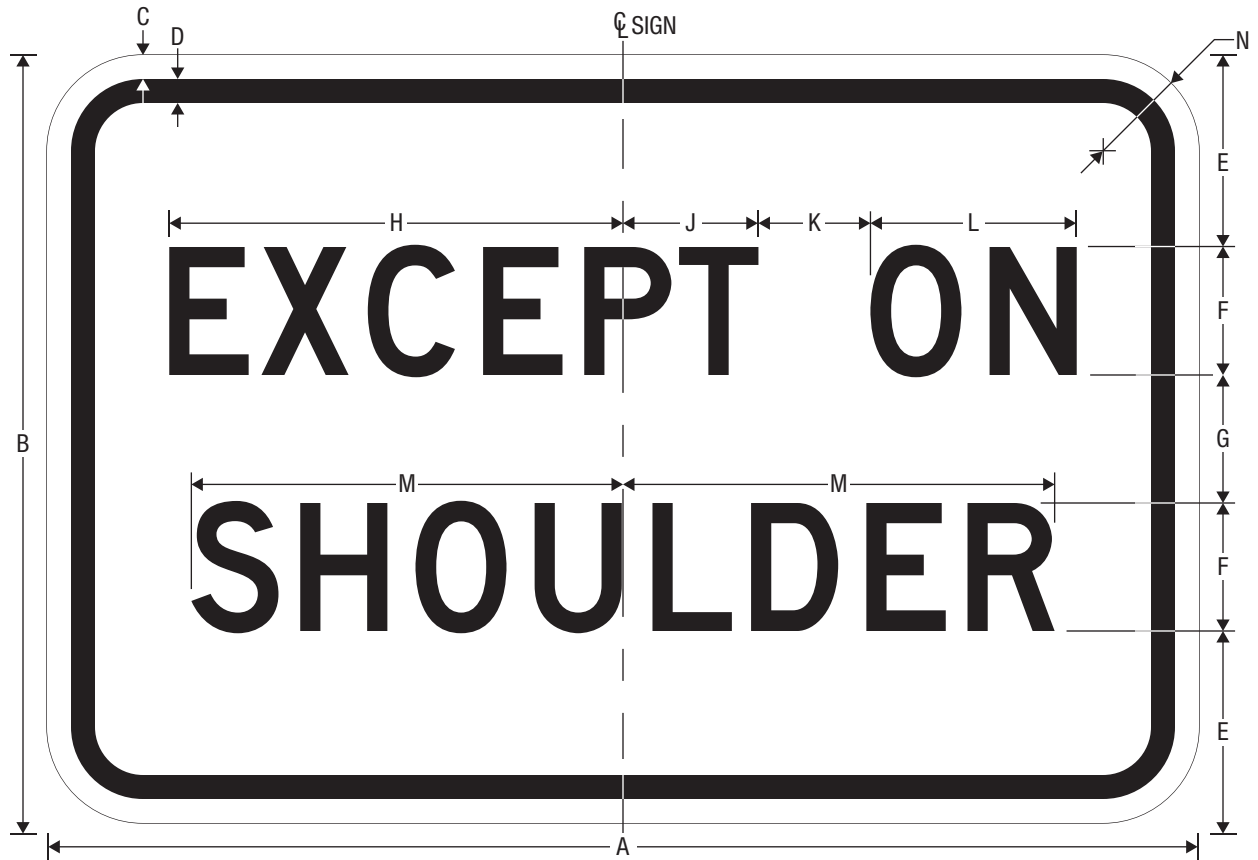

R9-19P

EXCEPT ON SHOULDER (PLAQUE)

A	B	C	D	E	F	G	H	J	K	L	M	N
18	12	0.375	0.375	3	2 D	2	7.090	2.116	1.75	3.223	6.745	1.5
24	18	0.375	0.5	4.5	3 C	3	9.439	2.386	3	4.052	8.568	1.5
30	24	0.375	0.625	6	4 C	4	12.334	3.432	3.5	5.402	11.424	1.5

COLORS: LEGEND, BORDER — BLACK (RETROREFLECTIVE)  
BACKGROUND — WHITE (RETROREFLECTIVE)





R9-21

BICYCLES USE SHOULDER ONLY

\* See page 8-4 for symbol design.

\*\* Reduce Spacing 20%.

A	B	C	D	E	F	G	H
24	30	0.375	0.625	2.75	7.5	2.125	3.5 C

J	K	L	M	N	P	Q	R
3.5 C**	2.875	6.563	6.562	3.449	9.541	4.867	1.5

COLORS: LEGEND, BORDER — BLACK  
BACKGROUND — WHITE (RETROREFLECTIVE)



R9-22  
BICYCLES MUST EXIT

\* Reduce Spacing 30%.

\*\* See page 7-3 for arrow design.

A	B	C	D	E	F	G	H	J
24	30	0.375	0.625	2.875	4 C*	2.349	4 C	9.582

K	L	M	N	P	Q	R	S	T
9.581	5.543	5.542	4.242	4.241	5.447	5.25	12	1.5

COLORS: LEGEND, BORDER – BLACK  
BACKGROUND – WHITE (RETROREFLECTIVE)

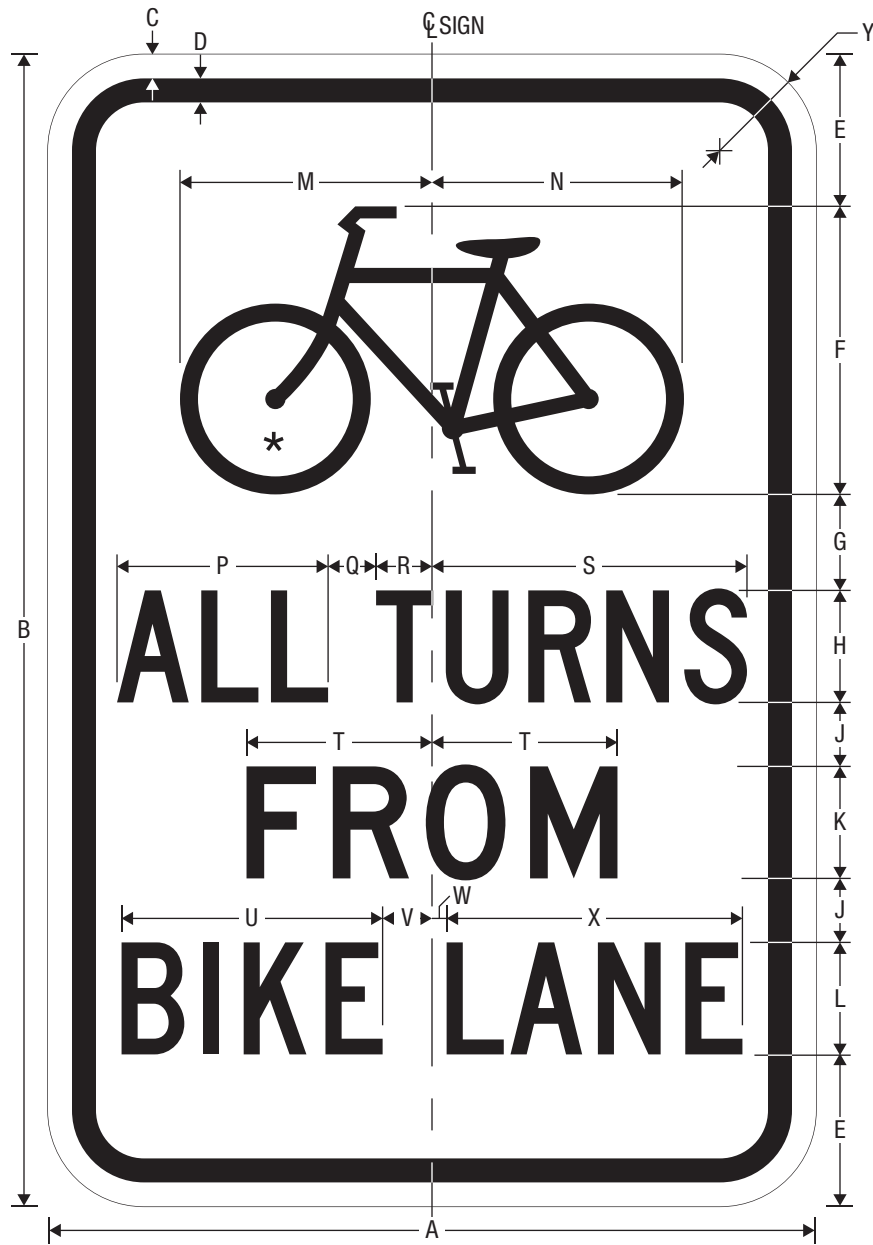

R9-23

BICYCLE ALL TURNS FROM BIKE LANE

\* See page 8-4 for symbol design.

\*\* Reduce Spacing 20%.

A	B	C	D	E	F	G	H	J	K	L	M
12	18	0.375	0.375	2.375	4.5	1.5	1.75 C**	1	1.75 D	1.75 C	3.938

N	P	Q	R	S	T	U	V	W	X	Y
3.937	3.298	0.75	0.874	4.921	2.898	4.079	0.772	0.228	4.622	1.5

COLORS: LEGEND, BORDER — BLACK  
BACKGROUND — WHITE (RETROREFLECTIVE)

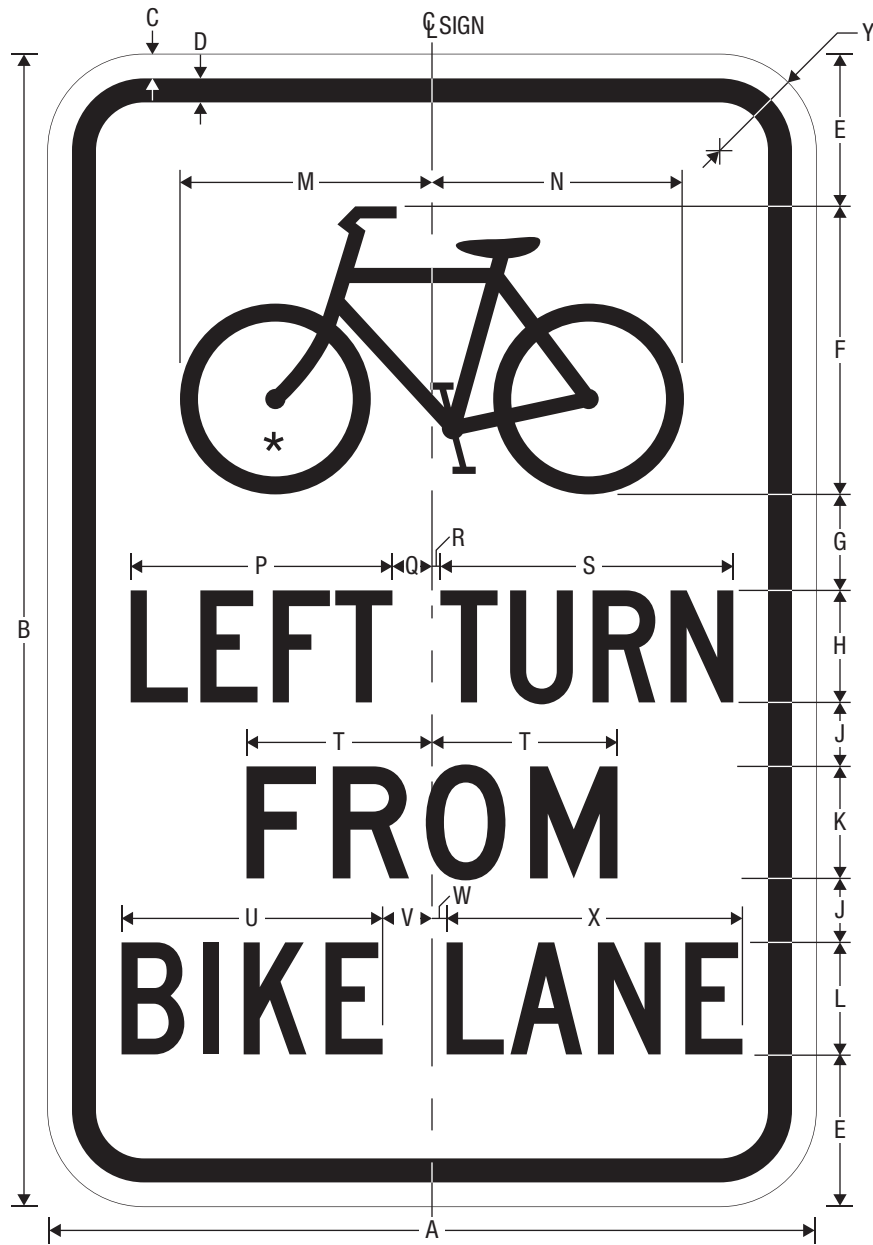

R9-23a

BICYCLE LEFT TURN FROM BIKE LANE

\* See page 8-4 for symbol design.

\*\* Reduce Spacing 20%.

A	B	C	D	E	F	G	H	J	K	L	M
12	18	0.375	0.375	2.375	4.5	1.5	1.75 C**	1	1.75 D	1.75 C	3.938

N	P	Q	R	S	T	U	V	W	X	Y
3.937	4.090	0.619	0.131	4.576	2.898	4.079	0.772	0.228	4.622	1.5

COLORS: LEGEND, BORDER — BLACK  
BACKGROUND — WHITE (RETROREFLECTIVE)



R9-23b

BICYCLE LEFT TURN MUST USE TURN BOX

\* See page 8-4 for symbol design.

\*\* Reduce Spacing 20%.

A	B	C	D	E	F	G	H	J	K	L	M
12	18	0.375	0.375	2.375	4.5	1.5	1.75 C**	1	1.75 C	3.938	3.937

N	P	Q	R	S	T	U	V	W	X	Y
4.090	0.618	0.132	4.576	4.650	0.200	3.449	4.641	0.121	3.519	1.5

COLORS: LEGEND, BORDER — BLACK  
BACKGROUND — WHITE (RETROREFLECTIVE)



R9-23c

BICYCLE LEFT TURN MUST USE TURN BOX (WITH ARROW, OBLIQUE)

- \* See page 8-4 for symbol design.
- \*\* Reduce Spacing 20%.
- \*\*\* See page 7-3 for arrow design.

A	B	C	D	E	F	G	H	J	K	L
12	18	0.375	0.375	1.375	4.5	0.75	1.75 C**	1	1.75 C	0.5

M	N	P	Q	R	S	T	U	V	W
2.630	0.995	3.938	3.937	4.090	0.618	0.132	4.576	4.650	0.200

X	Y	Z	AA	BB	CC	DD	EE	FF	GG
3.449	4.641	0.121	3.519	1.315	1.314	0.938	3.25	2.5	1.5

COLORS: LEGEND, BORDER — BLACK  
BACKGROUND — WHITE (RETROREFLECTIVE)

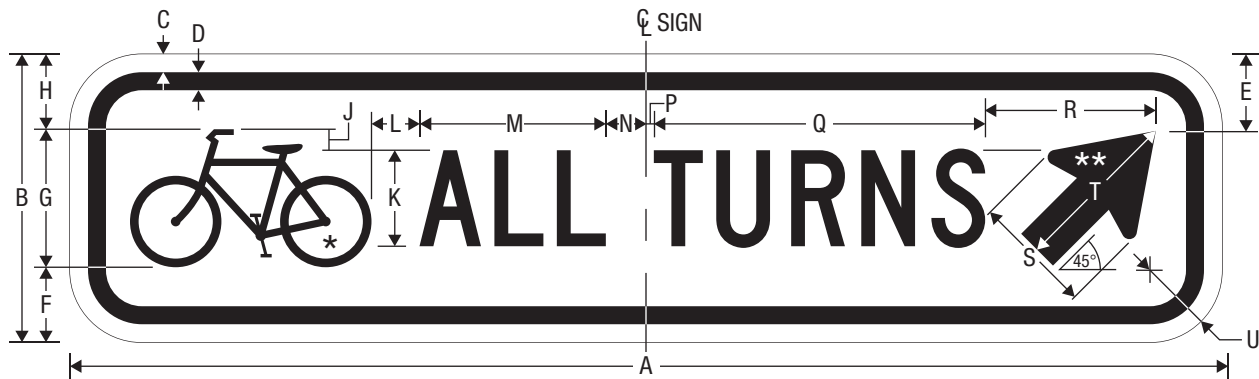

R9-24

BICYCLE ALL TURNS (WITH ARROW, OBLIQUE)

\* See page 8-4 for symbol design.

\*\* See page 7-3 for arrow design.

A	B	C	D	E	F	G	H	J	K
24	6	0.375	0.375	1.597	1.562	2.875	1.563	0.437	2 C

L	M	N	P	Q	R	S	T	U
1	3.882	0.837	0.163	6.903	3.556	2.5	3.5	1.5

COLORS: LEGEND, BORDER — BLACK  
BACKGROUND — WHITE (RETROREFLECTIVE)

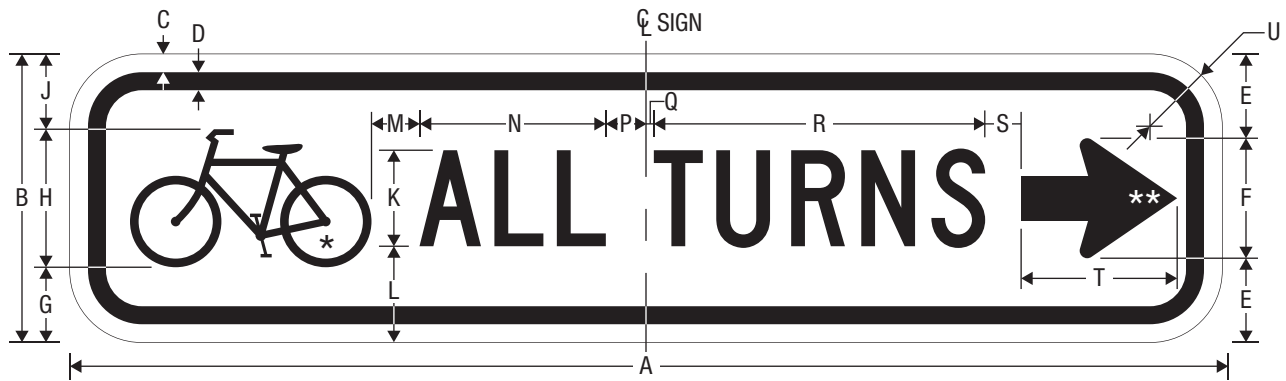

R9-24a

BICYCLE ALL TURNS (WITH ARROW, HORIZONTAL)

\* See page 8-4 for symbol design.

\*\* See page 7-3 for arrow design.

A	B	C	D	E	F	G	H	J	K
24	6	0.375	0.375	1.75	2.5	1.562	2.875	1.563	2 C

L	M	N	P	Q	R	S	T	U
2	1	3.882	0.837	0.163	6.903	0.75	3.25	1.5

COLORS: LEGEND, BORDER — BLACK  
BACKGROUND — WHITE (RETROREFLECTIVE)



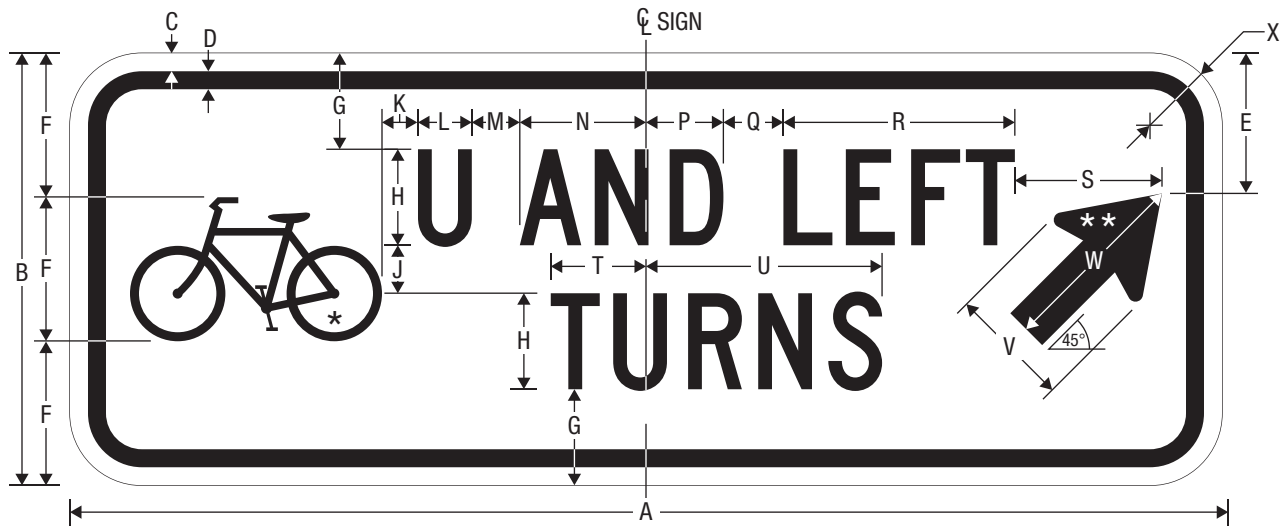

R9-25

BICYCLE U AND LEFT TURNS (WITH ARROW, OBLIQUE)

\* See page 8-4 for symbol design.

\*\* See page 7-3 for arrow design.

A	B	C	D	E	F	G	H	J	K	L
24	9	0.375	0.375	2.920	3	2	2 C	1	0.75	1.121

M	N	P	Q	R	S	T	U	V	W	X
1	2.629	1.613	1.25	4.822	3.066	1.984	4.919	2.5	4	1.5

COLORS: LEGEND, BORDER – BLACK  
BACKGROUND – WHITE (RETROREFLECTIVE)

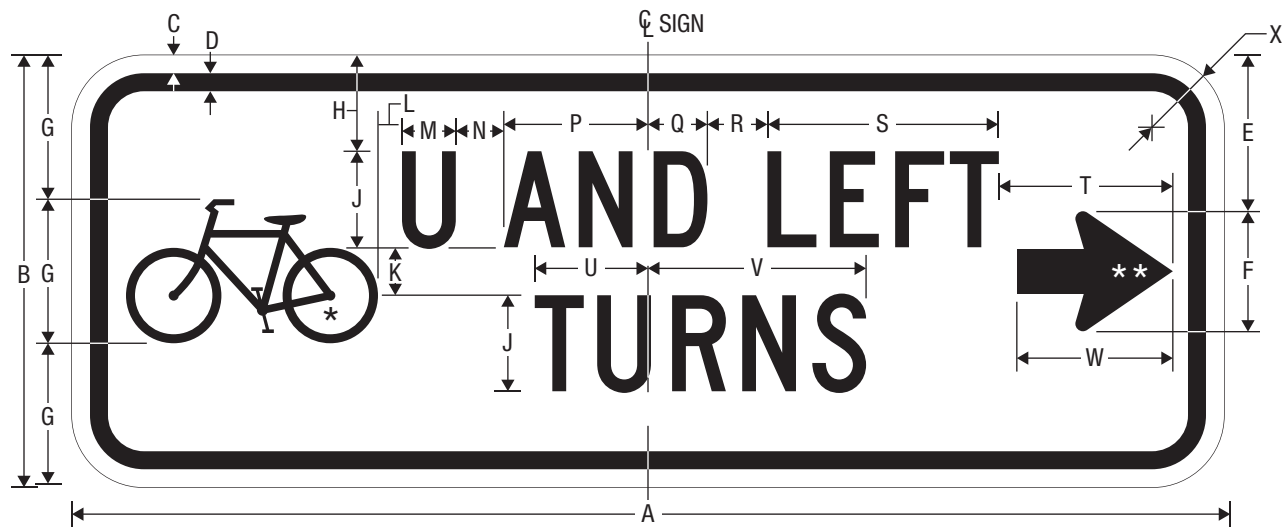

R9-25a

BICYCLE U AND LEFT TURNS (WITH ARROW, HORIZONTAL)

\* See page 8-4 for symbol design.

\*\* See page 7-3 for arrow design.

A	B	C	D	E	F	G	H	J	K	L
24	9	0.375	0.375	3.25	2.5	3	2	2 C	1	0.5

M	N	P	Q	R	S	T	U	V	W	X
1.121	1	3.004	1.238	1.25	4.822	3.625	2.359	4.544	3.25	1.5

COLORS: LEGEND, BORDER – BLACK  
BACKGROUND – WHITE (RETROREFLECTIVE)

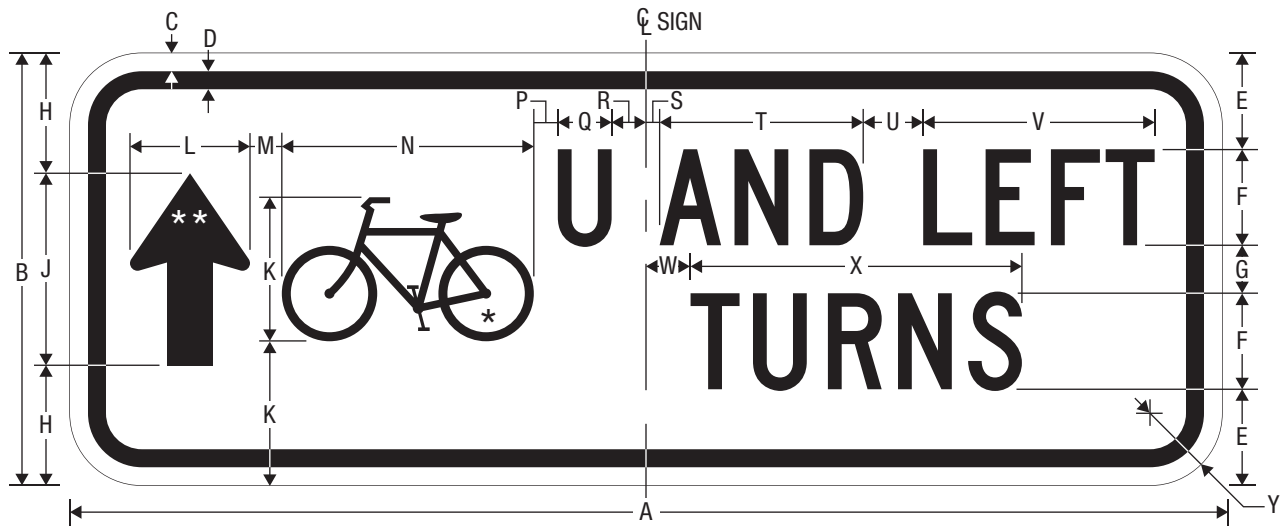

R9-25b

BICYCLE U AND LEFT TURNS (WITH ARROW, THROUGH)

\* See page 8-4 for symbol design.

\*\* See page 7-3 for arrow design.

A	B	C	D	E	F	G	H	J	K	L	M
24	9	0.375	0.375	2	2 C	1	2.5	4	3	2.5	0.663

N	P	Q	R	S	T	U	V	W	X	Y
5.25	0.5	1.121	0.716	0.284	4.242	1.25	4.822	0.929	6.903	1.5

COLORS: LEGEND, BORDER — BLACK  
BACKGROUND — WHITE (RETROREFLECTIVE)

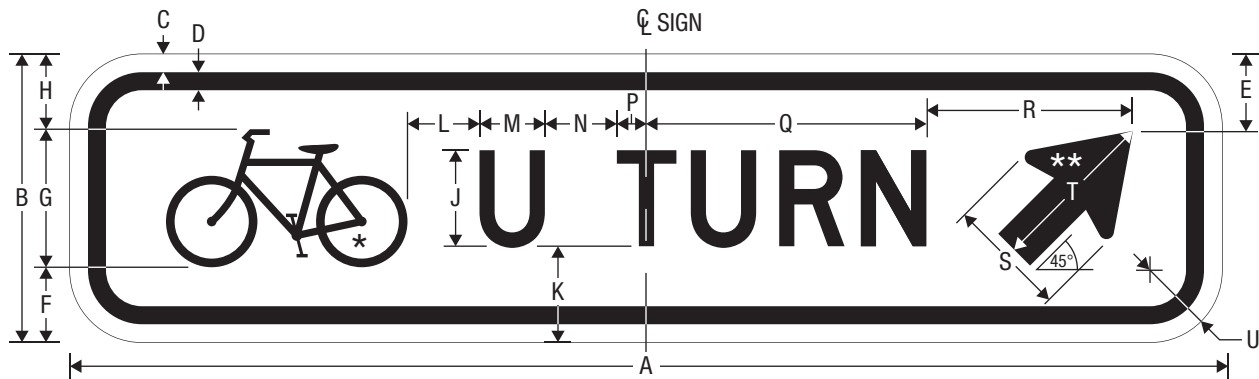

R9-26

BICYCLE U TURN (WITH ARROW, OBLIQUE)

\* See page 8-4 for symbol design.

\*\* See page 7-3 for arrow design.

A	B	C	D	E	F	G	H	J	K
24	6	0.375	0.375	1.597	1.562	2.875	1.563	2 D	2

L	M	N	P	Q	R	S	T	U
1.5	1.362	1.5	0.607	5.838	4.306	2.5	3.5	1.5

COLORS: LEGEND, BORDER — BLACK  
BACKGROUND — WHITE (RETROREFLECTIVE)

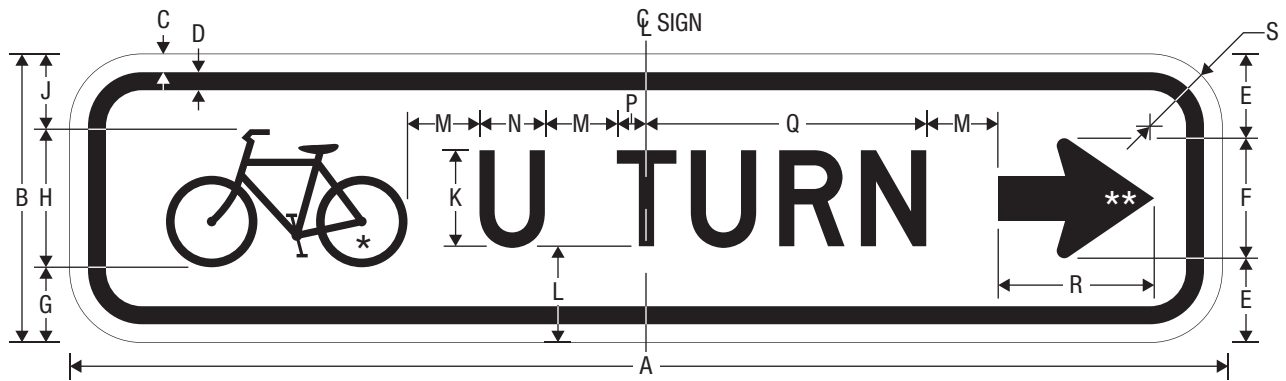

R9-26a

BICYCLE U TURN (WITH ARROW, HORIZONTAL)

\* See page 8-4 for symbol design.

\*\* See page 7-3 for arrow design.

A	B	C	D	E	F	G	H	J
24	6	0.375	0.375	1.75	2.5	1.562	2.875	1.563

K	L	M	N	P	Q	R	S
2 D	2	1.5	1.362	0.607	5.838	3.25	1.5

COLORS: LEGEND, BORDER – BLACK  
BACKGROUND – WHITE (RETROREFLECTIVE)

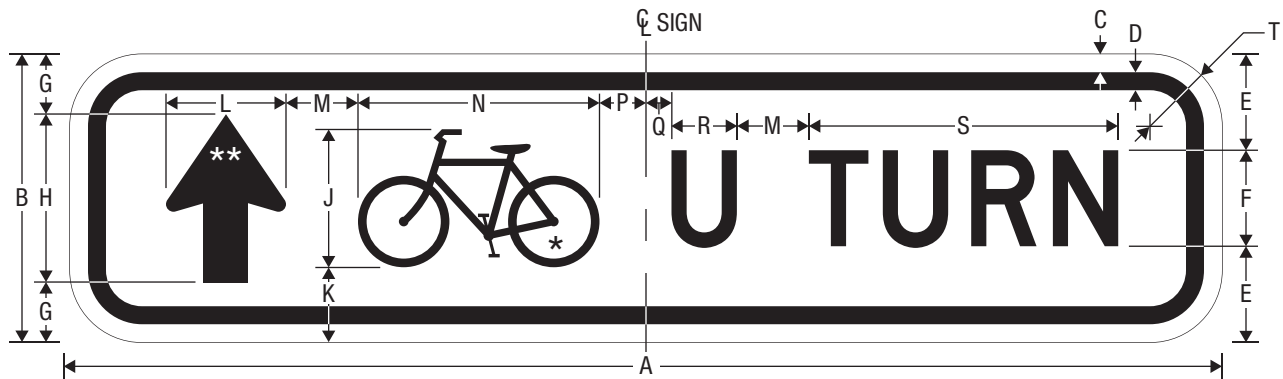

R9-26b

BICYCLE U TURN (WITH ARROW, THROUGH)

\* See page 8-4 for symbol design.

\*\* See page 7-3 for arrow design.

A	B	C	D	E	F	G	H	J
24	6	0.375	0.375	2	2 D	1.25	3.5	2.875

K	L	M	N	P	Q	R	S	T
1.625	2.5	1.5	5.031	0.969	0.531	1.362	6.445	1.5

COLORS: LEGEND, BORDER – BLACK  
BACKGROUND – WHITE (RETROREFLECTIVE)

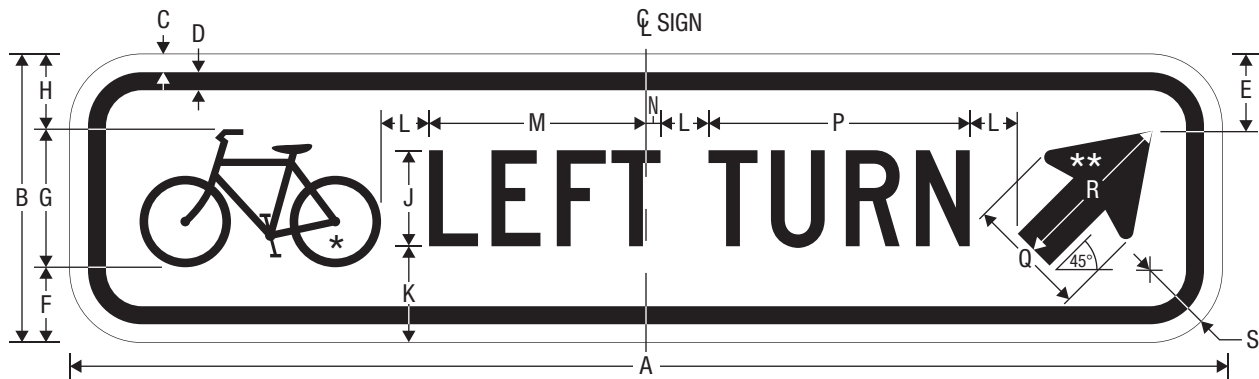

R9-27

BICYCLE LEFT TURN (WITH ARROW, OBLIQUE)

\* See page 8-4 for symbol design.

\*\* See page 7-3 for arrow design.

A	B	C	D	E	F	G	H	J
24	6	0.375	0.375	1.597	1.562	2.875	1.563	2 C

K	L	M	N	P	Q	R	S
2	1	4.520	0.302	5.442	2.5	3.5	1.5

COLORS: LEGEND, BORDER — BLACK  
BACKGROUND — WHITE (RETROREFLECTIVE)

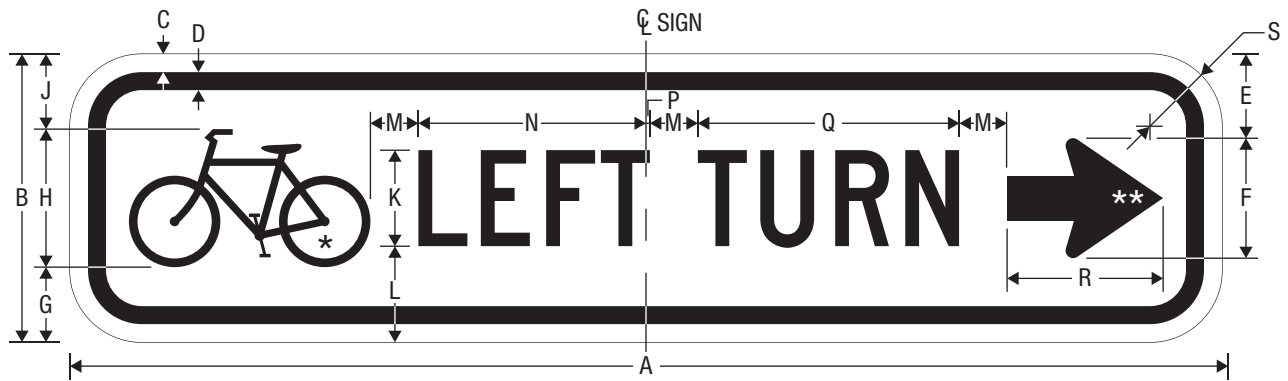

R9-27a

BICYCLE LEFT TURN (WITH ARROW, HORIZONTAL)

\* See page 8-4 for symbol design.

\*\* See page 7-3 for arrow design.

A	B	C	D	E	F	G	H	J
24	6	0.375	0.375	1.75	2.5	1.562	2.875	1.563

K	L	M	N	P	Q	R	S
2 C	2	1	4.741	0.081	5.442	3.25	1.5

COLORS: LEGEND, BORDER – BLACK  
BACKGROUND – WHITE (RETROREFLECTIVE)



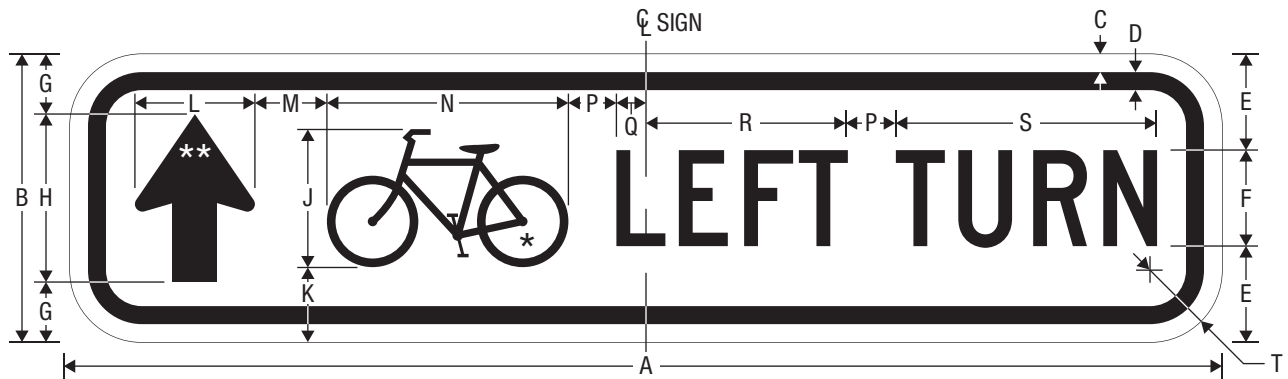

R9-27b

BICYCLE LEFT TURN (WITH ARROW, THROUGH)

\* See page 8-4 for symbol design.

\*\* See page 7-3 for arrow design.

A	B	C	D	E	F	G	H	J
24	6	0.375	0.375	2	2 C	1.25	3.5	2.875

K	L	M	N	P	Q	R	S	T
1.562	2.5	1.5	5.031	1	0.616	4.206	5.442	1.5

COLORS: LEGEND, BORDER — BLACK  
BACKGROUND — WHITE (RETROREFLECTIVE)

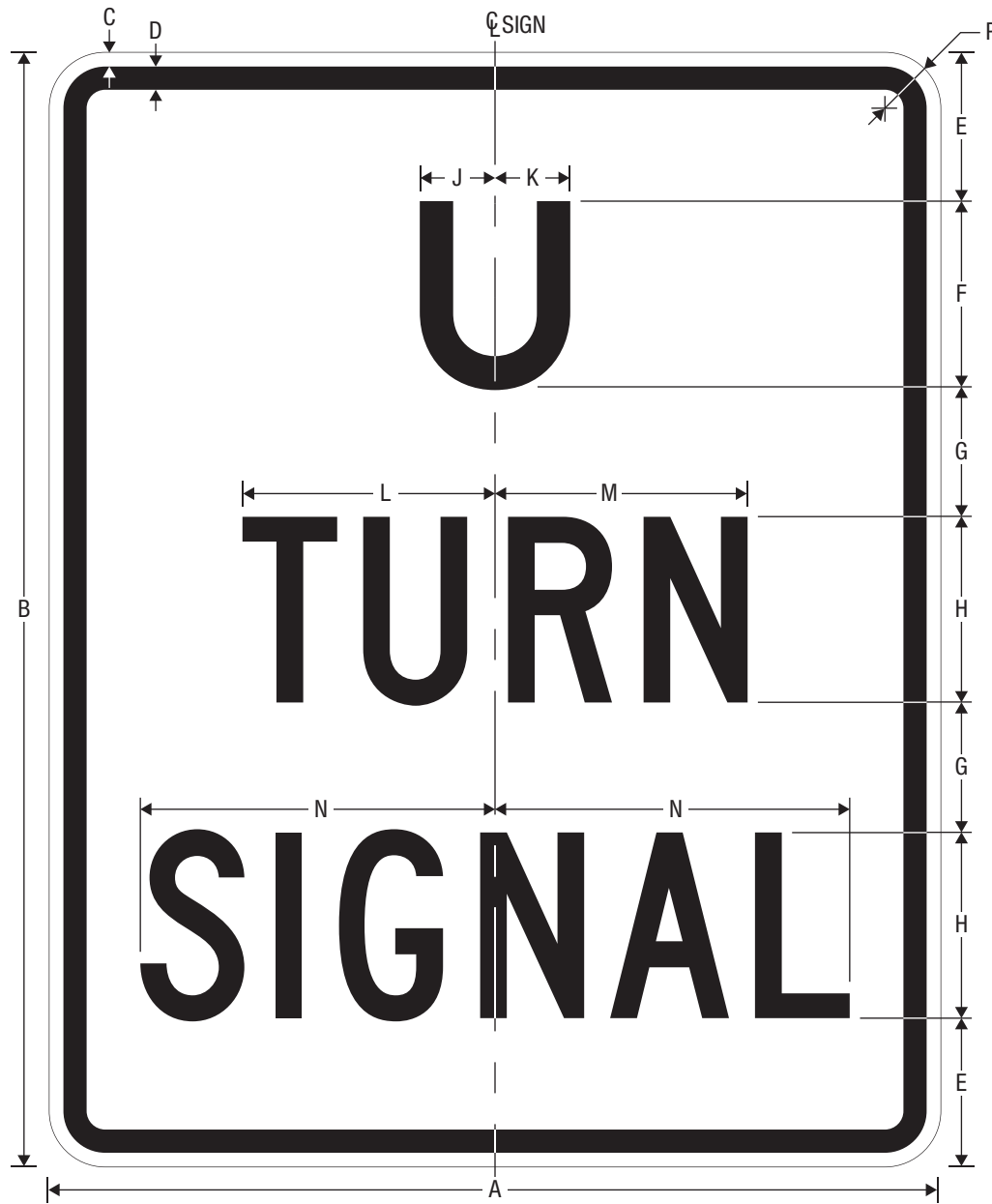

R10-10a  
U TURN SIGNAL

A	B	C	D	E	F	G	H
24	30	0.375	0.625	4	5 E	3.5	5 C
30	36	0.5	0.75	5	6 E	4	6 C

J	K	L	M	N	P
2.027	2.026	6.803	6.802	9.553	1.5
2.432	2.431	8.163	8.163	11.464	1.875

COLORS: LEGEND, BORDER — BLACK  
BACKGROUND — WHITE (RETROREFLECTIVE)

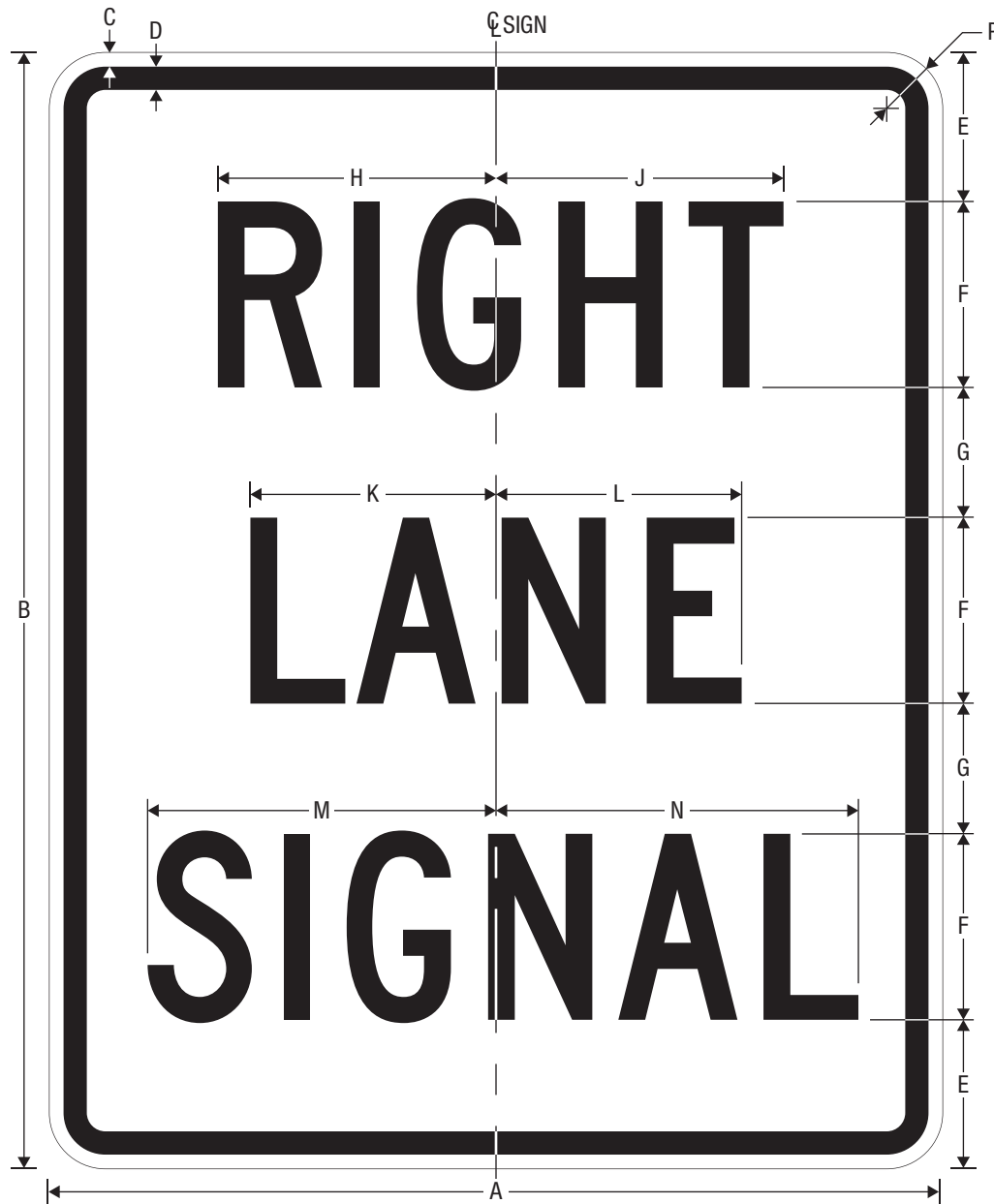

R10-10bR  
RIGHT LANE SIGNAL

A	B	C	D	E	F	G
24	30	0.375	0.625	4	5 C	3.5
30	36	0.5	0.75	5	6 C	4

H	J	K	L	M	N	P
7.478	7.727	6.603	6.602	9.366	9.740	1.5
8.967	9.279	7.923	7.923	11.214	11.714	1.875

COLORS: LEGEND, BORDER — BLACK  
BACKGROUND — WHITE (RETROREFLECTIVE)

2-325-1

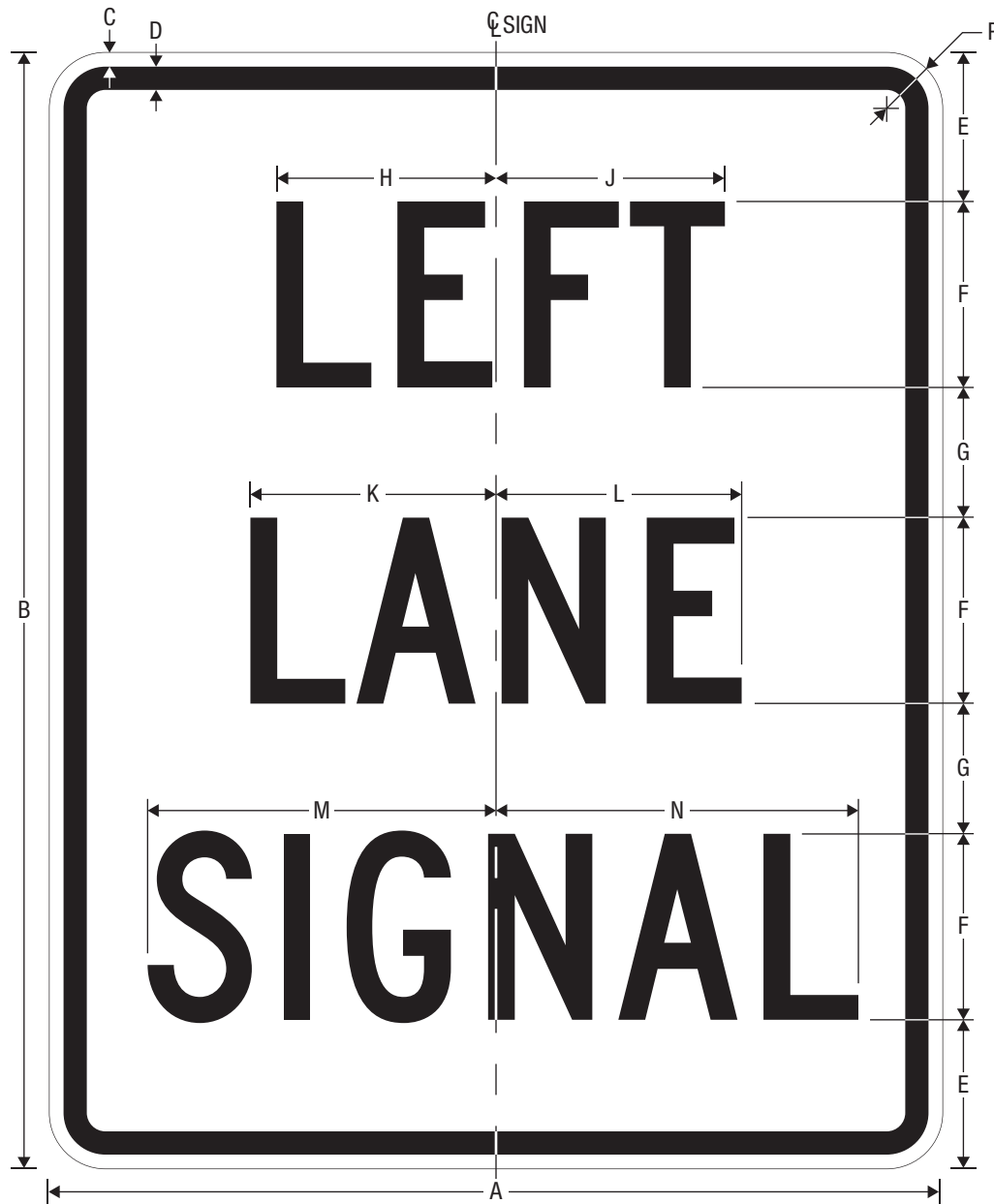

R10-10bL  
LEFT LANE SIGNAL

A	B	C	D	E	F	G
24	30	0.375	0.625	4	5 C	3.5
30	36	0.5	0.75	5	6 C	4

H	J	K	L	M	N	P
5.903	6.152	6.603	6.602	9.366	9.740	1.5
7.077	7.389	7.923	7.923	11.214	11.714	1.875

COLORS: LEGEND, BORDER — BLACK  
BACKGROUND — WHITE (RETROREFLECTIVE)

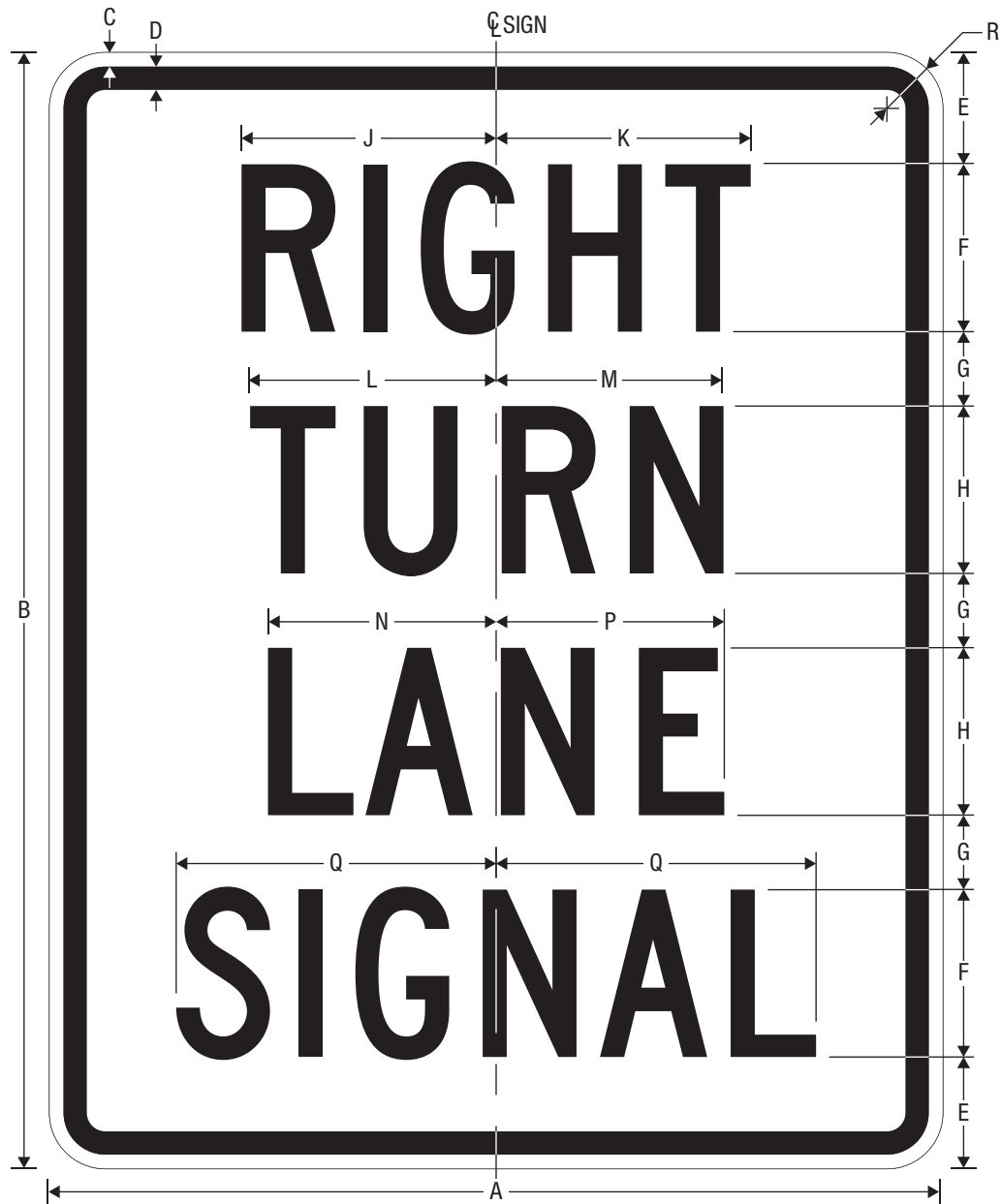

**R10-10cR**  
RIGHT TURN LANE SIGNAL

\* Increase Spacing 20%.

A	B	C	D	E	F	G	H
24	30	0.375	0.625	3	4.5 C	2	4.5 C*
30	36	0.5	0.75	3.75	5.25 C	2.5	5.25 C*

J	K	L	M	N	P	Q	R
6.842	6.842	6.611	6.111	6.132	6.131	8.598	1.5
7.983	7.982	7.921	6.921	7.153	7.153	10.031	1.875

COLORS: LEGEND, BORDER — BLACK  
BACKGROUND — WHITE (RETROREFLECTIVE)

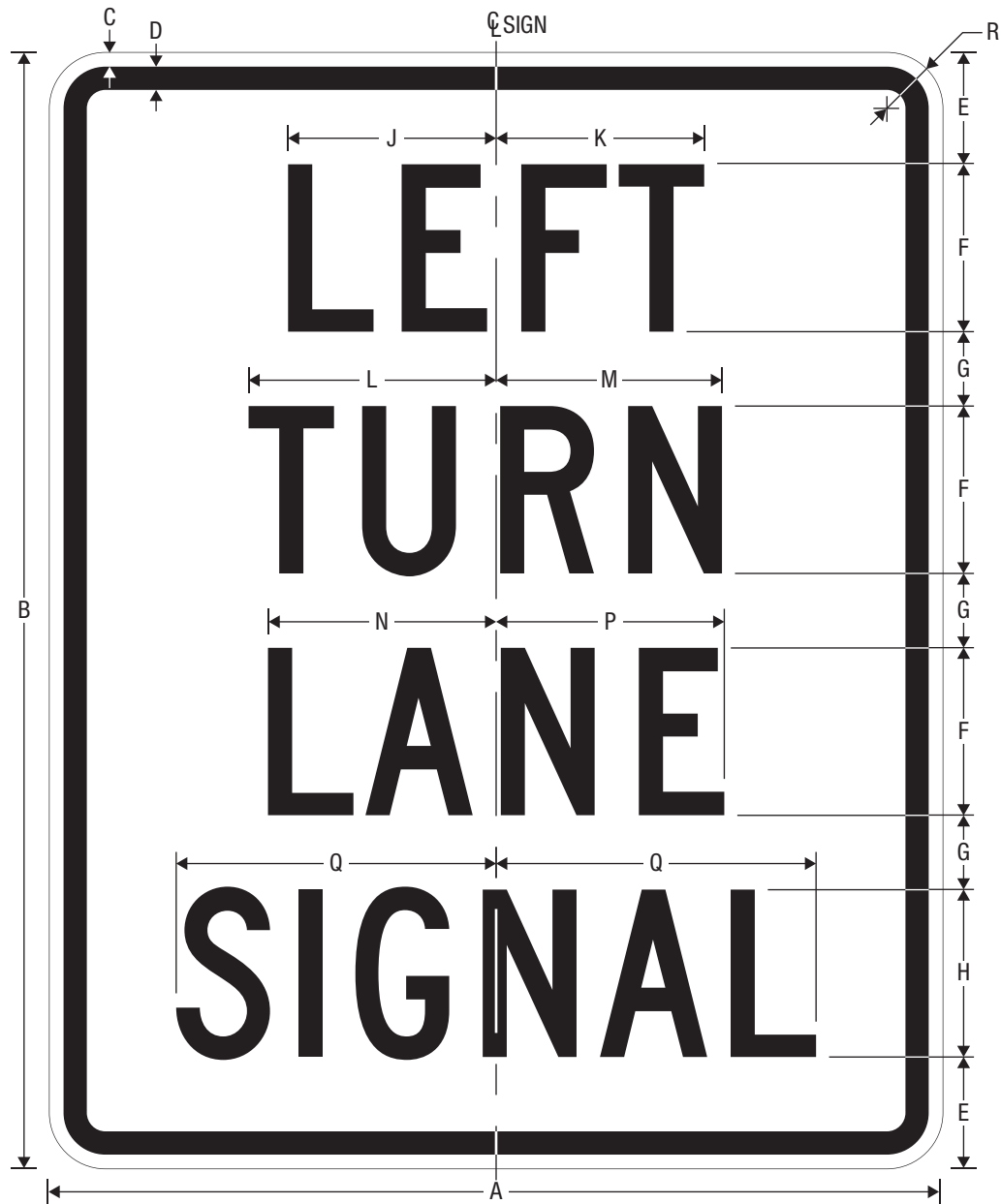

R10-10cL  
LEFT TURN LANE SIGNAL

\* Increase Spacing 20%.

A	B	C	D	E	F	G	H
24	30	0.375	0.625	3	4.5 C*	2	4.5 C
30	36	0.5	0.75	3.75	5.25 C*	2.5	5.25 C

J	K	L	M	N	P	Q	R
5.592	5.591	6.611	6.111	6.132	6.131	8.598	1.5
6.523	6.523	7.921	6.921	7.153	7.153	10.031	1.875

COLORS: LEGEND, BORDER — BLACK  
BACKGROUND — WHITE (RETROREFLECTIVE)

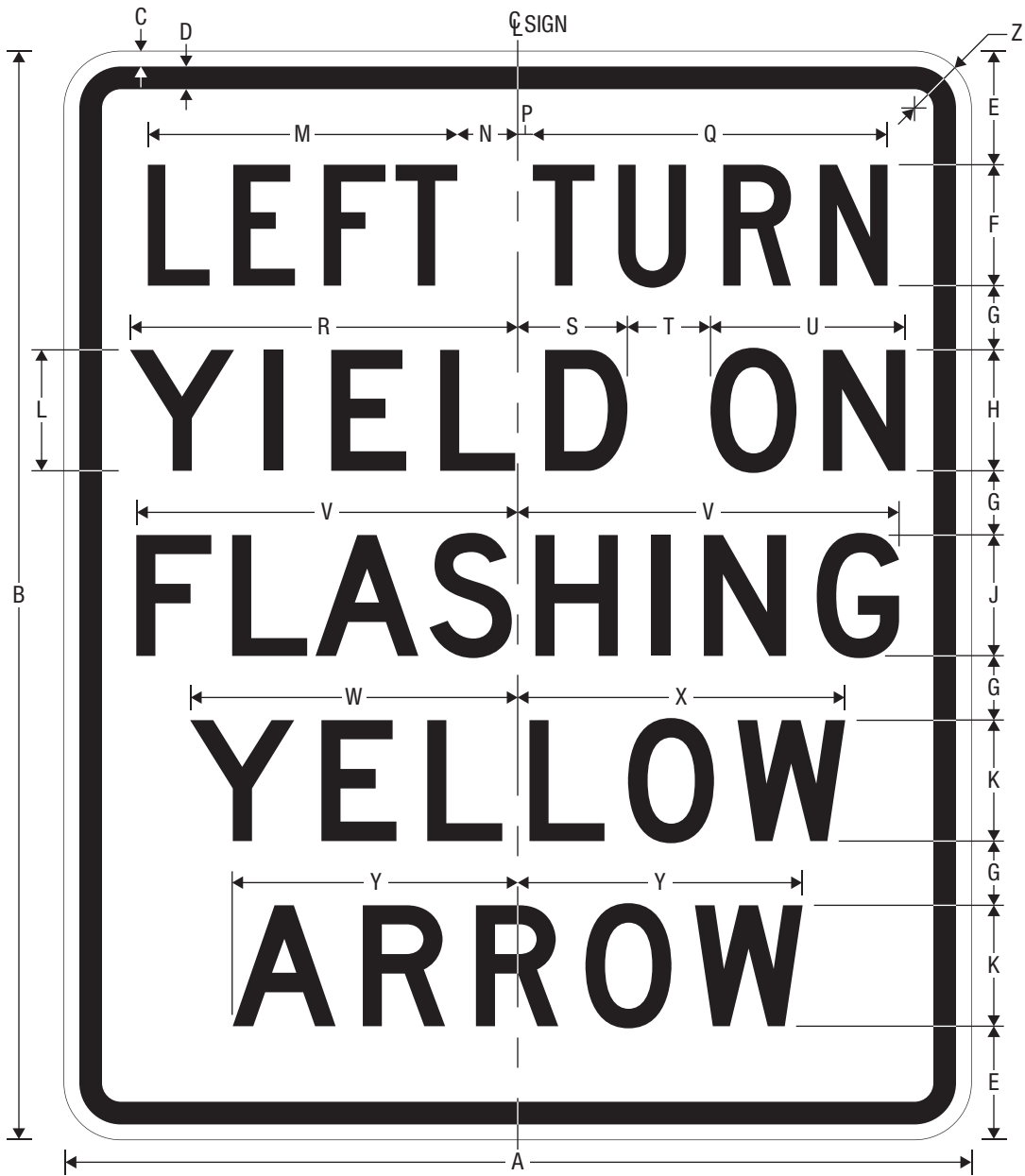

R10-12a

LEFT TURN YIELD ON FLASHING YELLOW ARROW

- \* Increase Spacing 40%.
- \*\* Increase Spacing 15%.
- \*\*\* Increase Spacing 50%.
- † Increase Spacing 65%.

A	B	C	D	E	F	G	H	J	K	L	M
30	36	0.5	0.75	3.75	4 C*	2.125	4 D	4 D**	4 D***	4 D†	10.236

N	P	Q	R	S	T	U	V	W	X	Y	Z
2	0.5	11.732	12.824	3.629	2.75	6.445	12.616	10.835	10.834	9.426	1.875

COLORS: LEGEND, BORDER — BLACK  
BACKGROUND — WHITE (RETROREFLECTIVE)

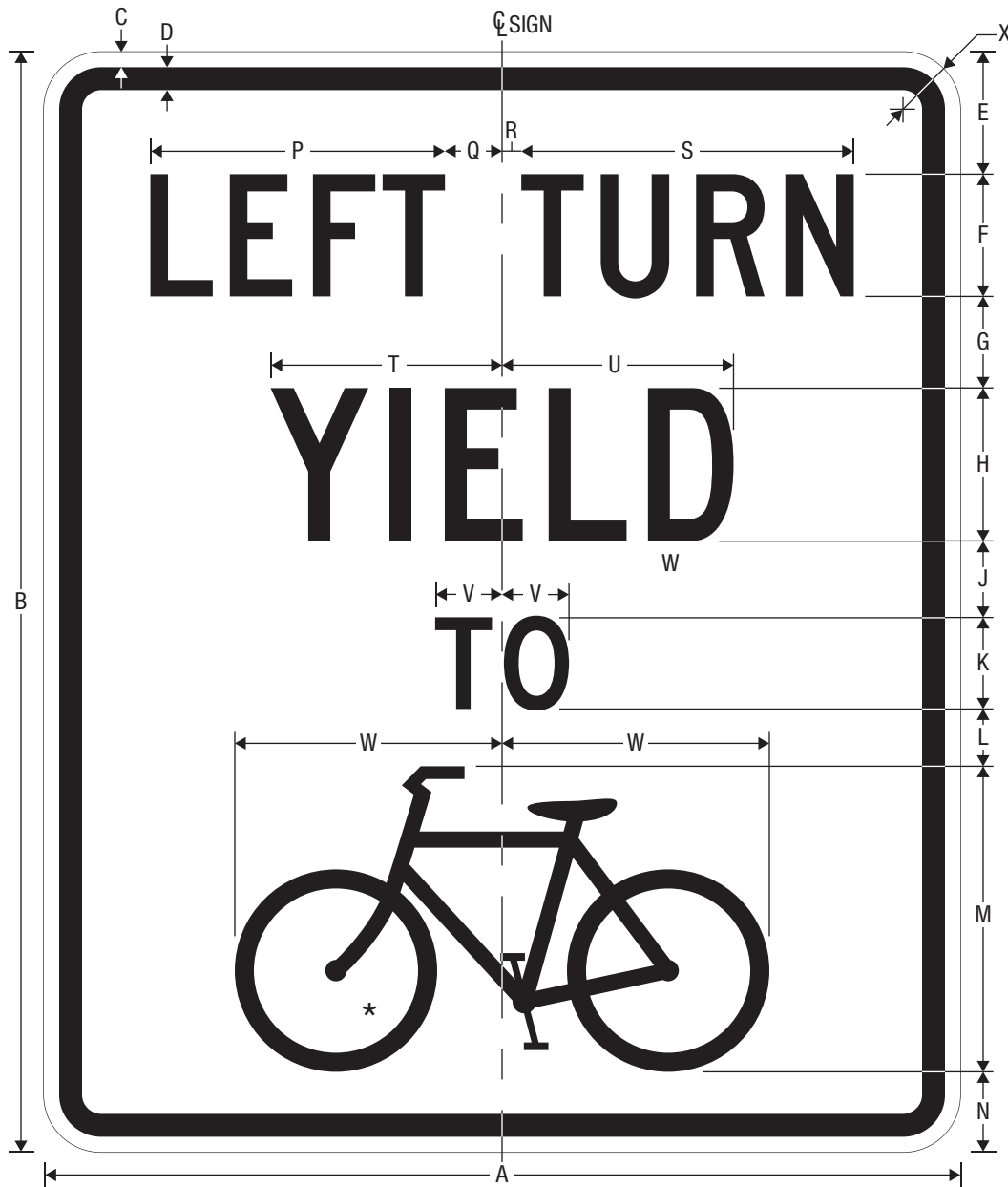

R10-12b

LEFT TURN YIELD TO BICYCLE

\* See page 8-4 for symbol design.

A	B	C	D	E	F	G	H	J	K	L
30	36	0.5	0.75	4	4 C	3	5 C	2.5	3 D	1.875

M	N	P	Q	R	S	T	U	V	W	X
10	2.625	9.644	1.870	0.630	10.884	7.578	7.577	2.191	8.75	1.875

COLORS: LEGEND, BORDER — BLACK  
BACKGROUND — WHITE (RETROREFLECTIVE)



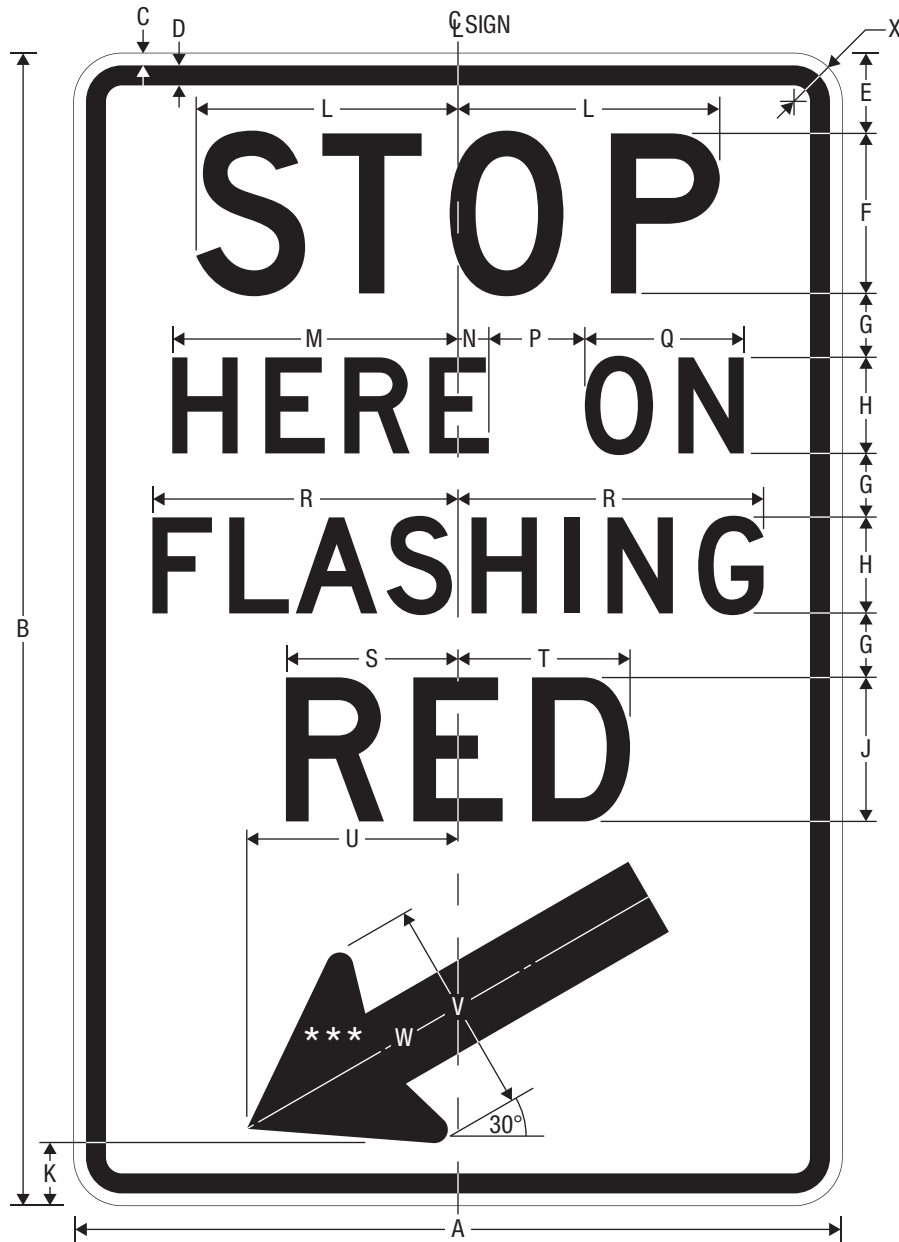

R10-14b

STOP HERE ON FLASHING RED

\* Increase Spacing 35%.

\*\* Increase Spacing 20%.

\*\*\* See page 7-3 for arrow design.

A	B	C	D	E	F	G	H	J	K	L
24	36	0.375	0.625	2.5	5 D*	2	3 D**	4.5 D**	1.967	8.182
36	48	0.625	0.875	3.75	7 D	2.5	4 D**	6 D**	2.702	10.928

M	N	P	Q	R	S	T	U	V	W	X
8.830	0.964	3	4.965	9.549	5.377	5.377	6.600	6.75	14.5	1.5
11.907	1.285	4	6.621	12.732	7.170	7.169	8.652	9.5	19	2.25

COLORS: LEGEND, BORDER — BLACK  
BACKGROUND — WHITE (RETROREFLECTIVE)



R10-15aR

TURNING VEHICLES STOP FOR PEDESTRIANS



R10-15aL

- \* Reduce Spacing 20%.
- \*\* See page 7-3 for arrow design.
- \*\*\* See page 8-7 for symbol design.

A	B	C	D	E	F	G	H	J	K	L
30	0.375	0.625	4.188	3.625	2	3.188	1.875	12	2.5	3.875

M	N	P	Q	R	S	T	U	V	W	X
9	3.5	3 C	3 D*	2.25	3 D	2.875	12.026	4.306	12.596	4.875

Y	Z	AA	BB	CC	DD	EE	FF	GG	HH
6.5	0.313	0.188	3.947	3.946	1.375	2.226	4.859	6.875	1.875

UPPER SECTION

COLORS: LEGEND, BORDER — BLACK  
 BACKGROUND — YELLOW (RETROREFLECTIVE) or  
 FLUORESCENT YELLOW-GREEN  
 (RETROREFLECTIVE)

LOWER SECTION

COLORS: LEGEND, BORDER — BLACK  
 STOP SIGN BACKGROUND — RED (RETROREFLECTIVE)  
 BACKGROUND,  
 STOP SIGN LEGEND — WHITE (RETROREFLECTIVE)

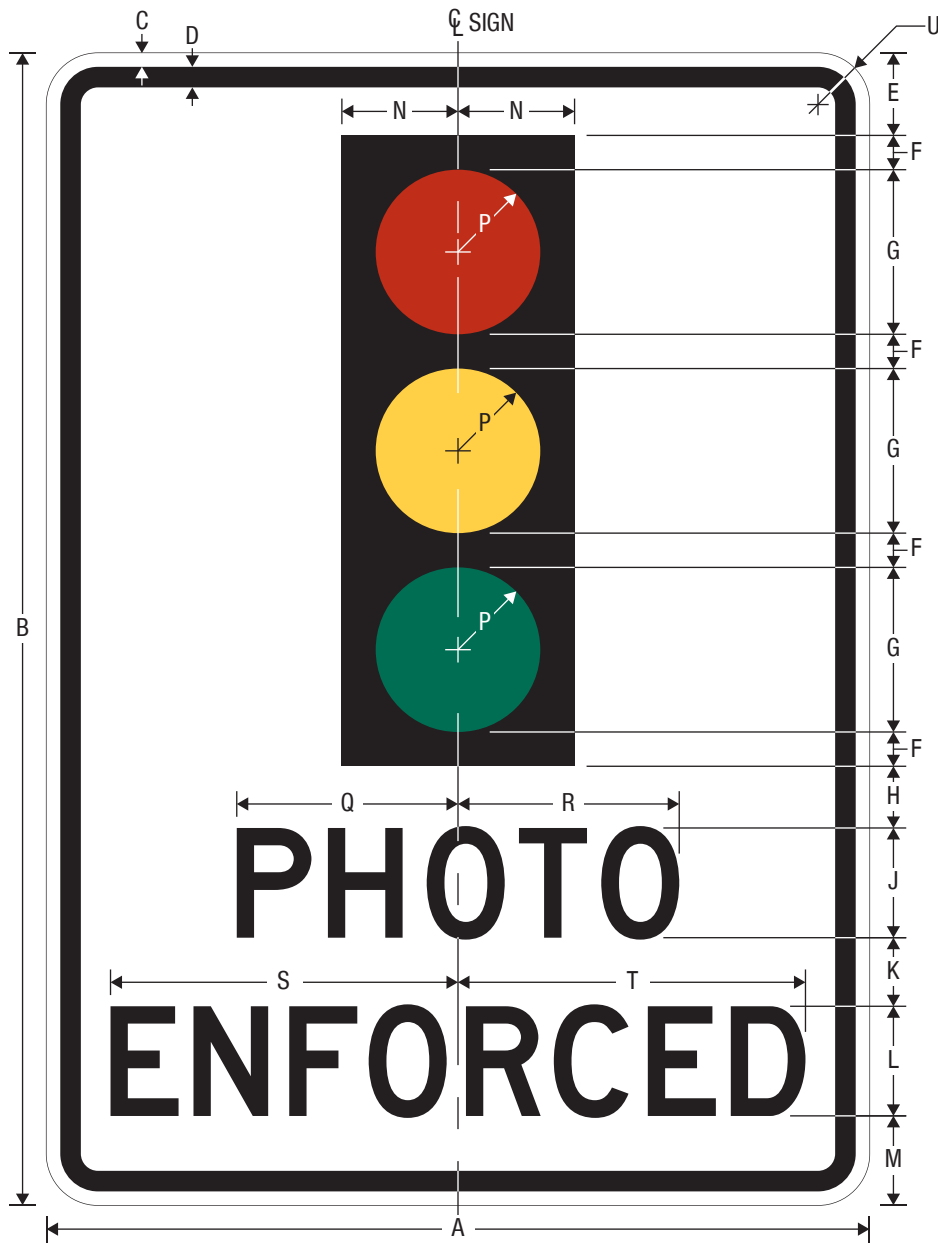

R10-18a  
TRAFFIC SIGNAL PHOTO ENFORCED

\* Reduce Spacing 20%.  
\*\* Reduce Spacing 40%.

A	B	C	D	E	F	G	H	J	K
30	42	0.5	0.75	3	1.25	6	2.25	4 D	2.5
36	54	0.625	0.875	4.5	1.625	7.5	3	5 D*	3

L	M	N	P	Q	R	S	T	U
4 D*	3.25	4.25	3	8.066	8.065	12.669	12.668	1.875
5 D**	4.5	5.375	3.75	9.767	9.767	15.186	15.185	2.25

- COLORS: LEGEND & BORDER  
 BACKGROUND  
 SYMBOL BACKGROUND  
 TOP CIRCLE  
 CENTER CIRCLE  
 BOTTOM CIRCLE
- BLACK
  - WHITE (RETROREFLECTIVE)
  - BLACK
  - RED (RETROREFLECTIVE)
  - YELLOW (RETROREFLECTIVE)
  - GREEN (RETROREFLECTIVE)

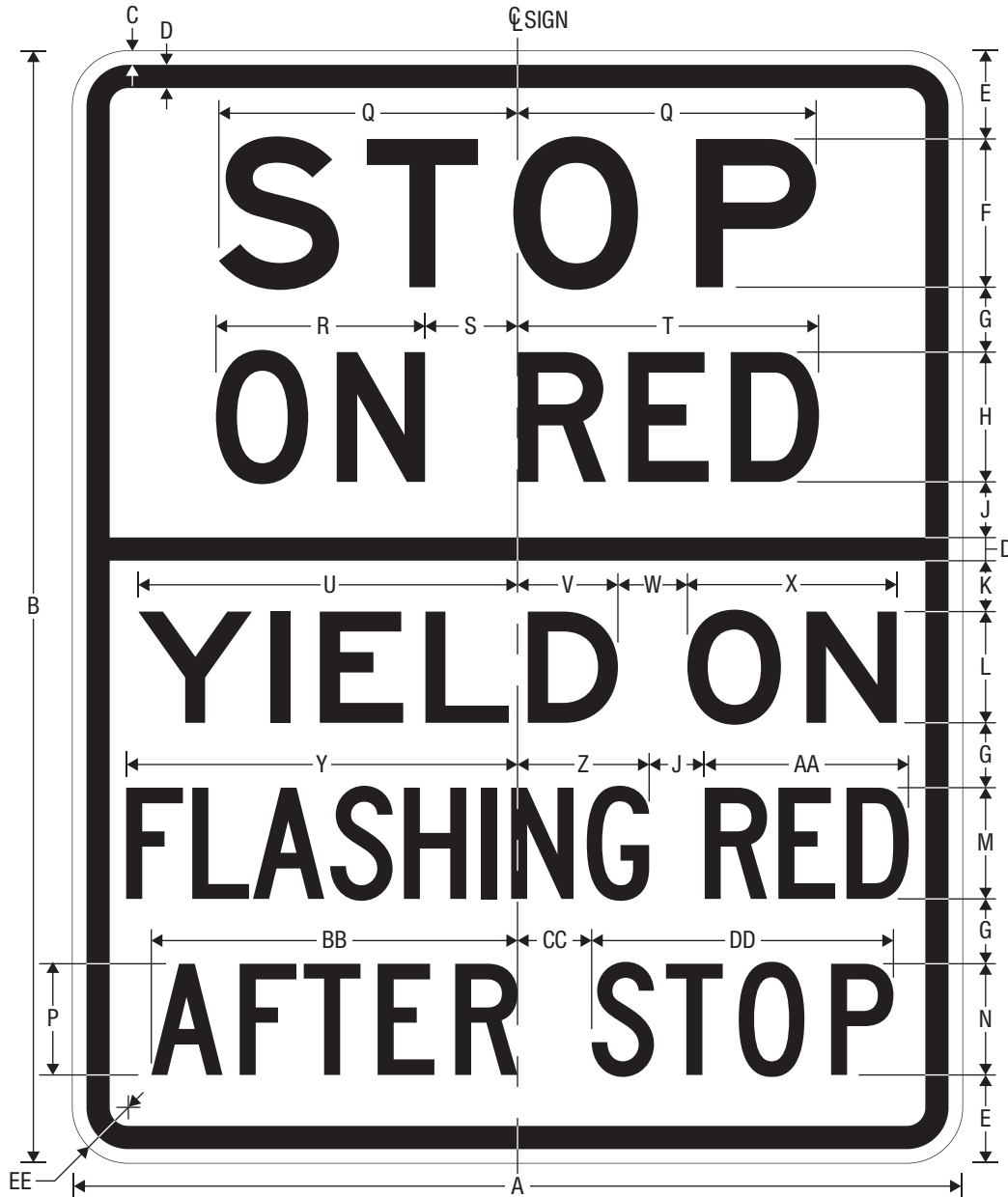

R10-23a

STOP ON RED - YIELD ON FLASHING RED AFTER STOP

- \* Increase Spacing 70%.
- \*\* Reduce Spacing 40%.
- \*\*\* Increase Spacing 20%.
- † Increase Spacing 10%.

A	B	C	D	E	F	G	H	J	K	L	M	N	P	Q
24	30	0.375	0.625	2.375	4 E*	1.75	3.5 D	1.5	1.375	3 E	3 C**	3 C***	3 C†	8.055

R	S	T	U	V	W	X	Y	Z	AA	BB	CC	DD	EE
5.639	2.5	8.126	10.226	2.708	1.875	5.643	10.555	3.550	5.504	9.877	2	8.139	1.5

COLORS: LEGEND, BORDER — BLACK  
BACKGROUND — WHITE (RETROREFLECTIVE)

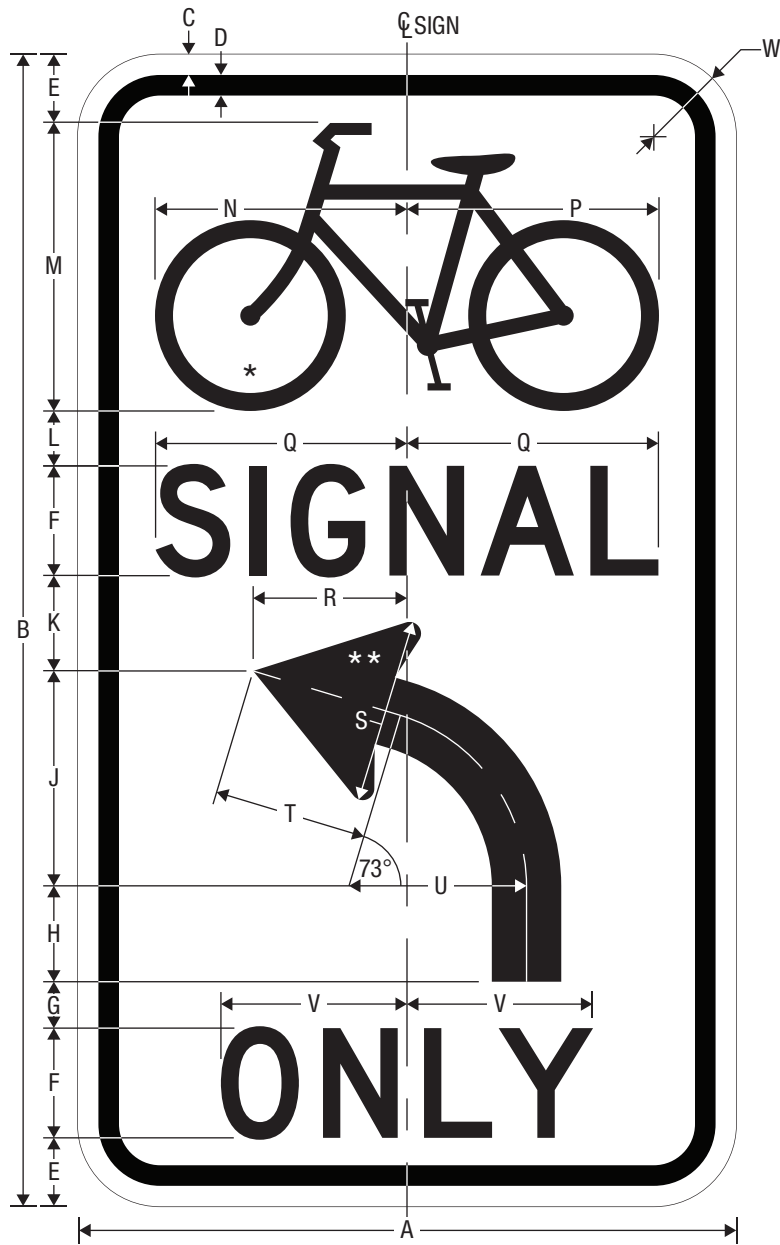

R10-40

BICYCLE SIGNAL MANDATORY MOVEMENT (TURN)

\* See page 8-4 for symbol design.

\*\* See page 7-3 for arrow design.

A	B	C	D	E	F	G	H	J	K	L
12	21	0.375	0.375	1.25	2 D	0.845	1.75	3.916	1.739	1
24	36	0.375	0.625	2.5	3.75 D	1.144	3.25	7.343	2.763	1.5

M	N	P	Q	R	S	T	U	V	W
5.25	4.594	4.593	4.583	2.720	3.375	2.803	3.241	3.392	1.5
7.5	6.563	6.562	8.593	6.361	6.25	5.257	6.096	6.360	1.5

COLORS: LEGEND, BORDER — BLACK  
BACKGROUND — WHITE (RETROREFLECTIVE)

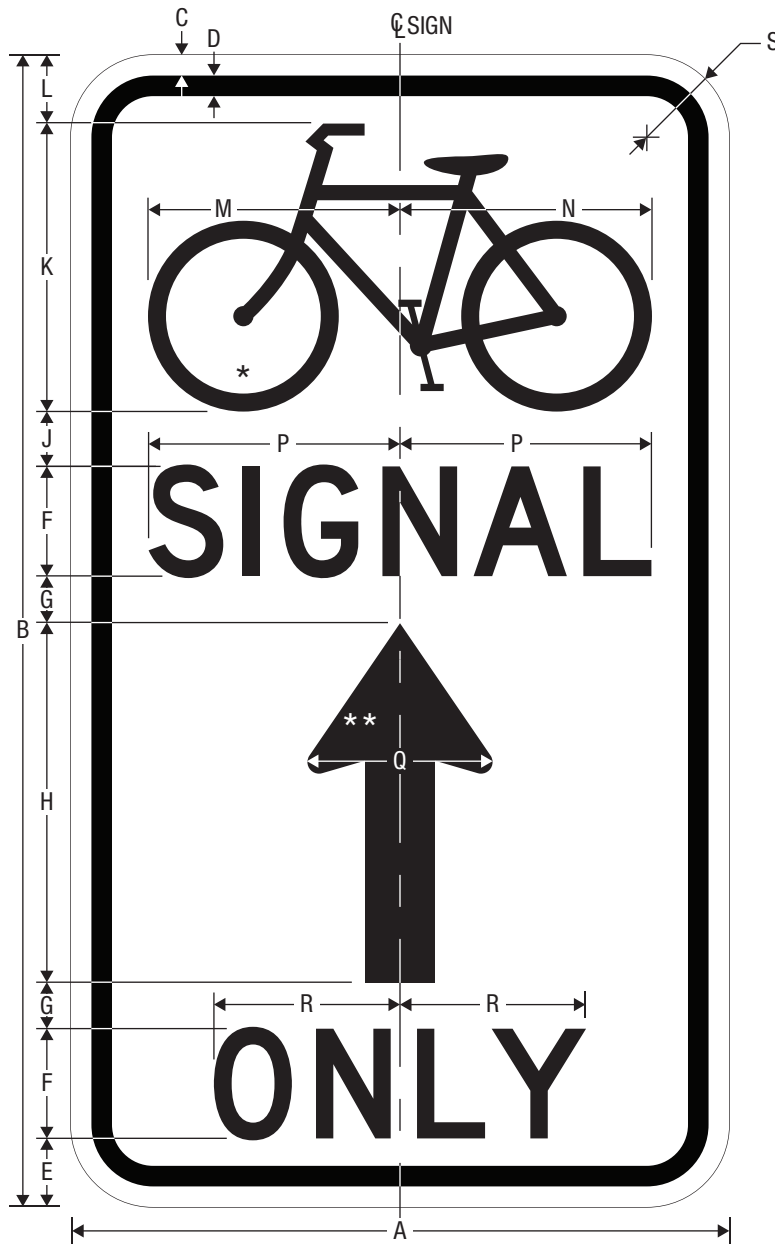

R10-40a

BICYCLE SIGNAL MANDATORY MOVEMENT (THRU)

\* See page 8-4 for symbol design.

\*\* See page 7-3 for arrow design.

A	B	C	D	E	F	G	H	J
12	21	0.375	0.375	1.25	2 D	0.846	6.558	1
24	36	0.375	0.625	2.5	3.75 D	1.144	12.212	1.5

K	L	M	N	P	Q	R	S
5.25	1.25	4.594	4.593	4.583	3.375	3.392	1.5
7.5	2.5	6.563	6.562	8.593	6.25	6.360	1.5

COLORS: LEGEND, BORDER — BLACK  
BACKGROUND — WHITE (RETROREFLECTIVE)

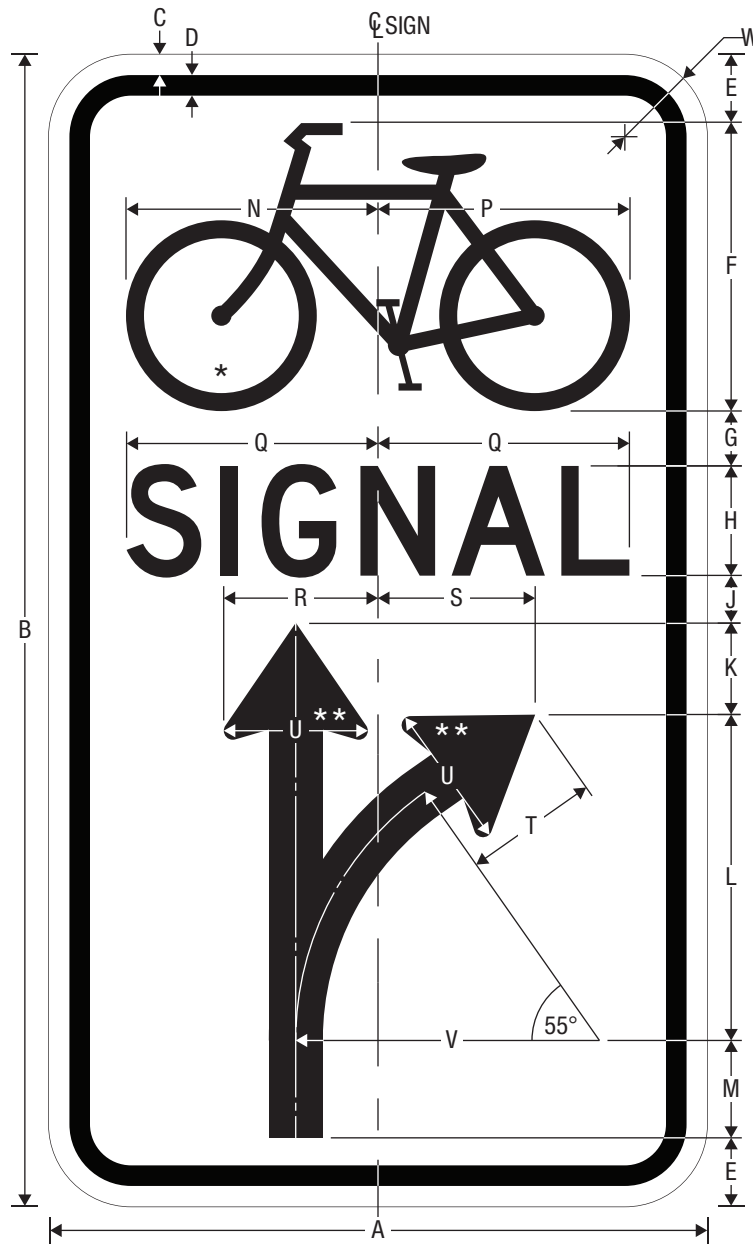

R10-41

BICYCLE SIGNAL OPTIONAL MOVEMENT (THRU AND TURN)

\* See page 8-4 for symbol design.

\*\* See page 7-3 for arrow design.

A	B	C	D	E	F	G	H	J	K	L
12	21	0.375	0.375	1.25	5.25	1	2 D	0.859	1.675	5.940
24	36	0.375	0.625	2.5	7.5	1.5	3.75 D	1.109	3.048	10.841

M	N	P	Q	R	S	T	U	V	W
1.777	4.594	4.593	4.583	2.811	2.866	2.449	2.625	5.541	1.5
3.243	6.563	6.562	8.593	5.125	5.218	4.470	4.75	10.114	1.5

COLORS: LEGEND, BORDER — BLACK  
BACKGROUND — WHITE (RETROREFLECTIVE)

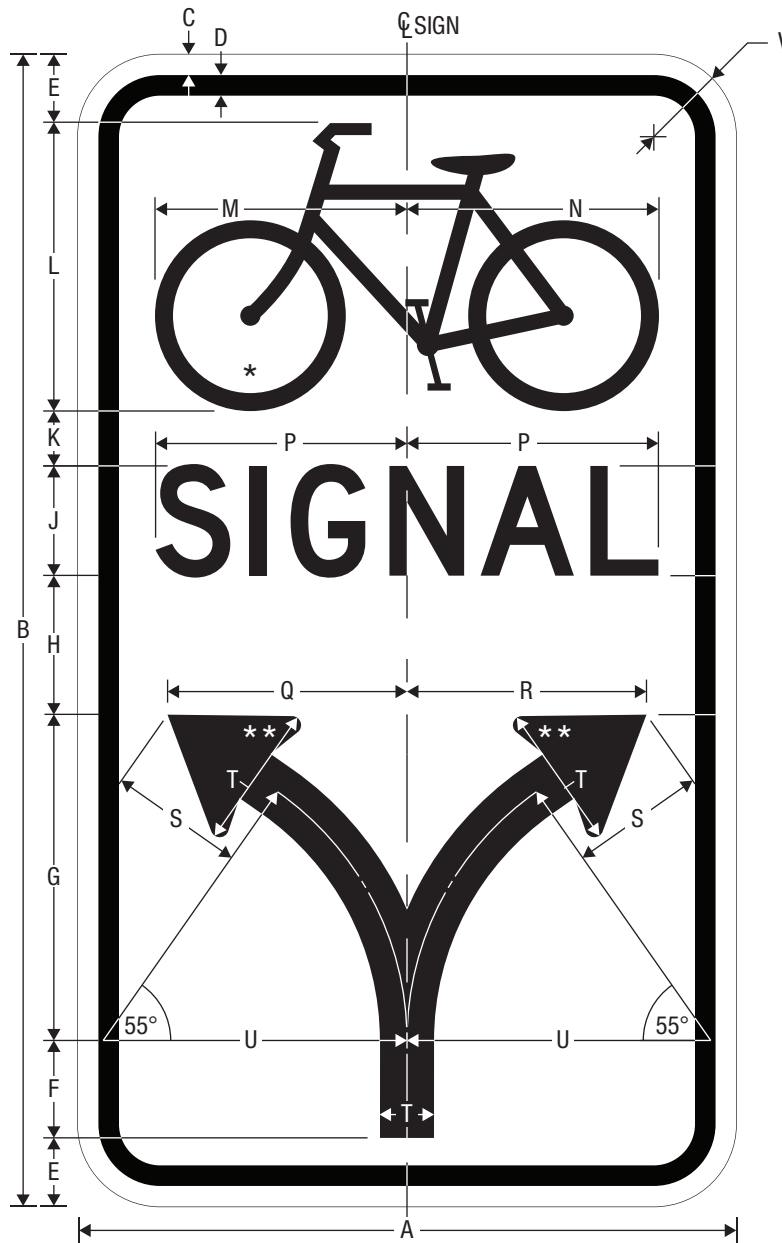

R10-41a

BICYCLE SIGNAL OPTIONAL MOVEMENT (LEFT AND RIGHT TURNS)

\* See page 8-4 for symbol design.

\*\* See page 7-3 for arrow design.

A	B	C	D	E	F	G	H	J	K
12	21	0.375	0.375	1.25	1.777	5.939	2.534	2 D	1
24	36	0.375	0.625	2.5	3.243	10.841	4.166	3.75 D	1.5

L	M	N	P	Q	R	S	T	U	V
5.25	4.594	4.593	4.583	4.366	4.365	2.450	2.625	5.541	1.5
7.5	6.563	6.562	8.593	7.969	7.968	4.473	4.75	10.114	1.5

COLORS: LEGEND, BORDER — BLACK  
BACKGROUND — WHITE (RETROREFLECTIVE)



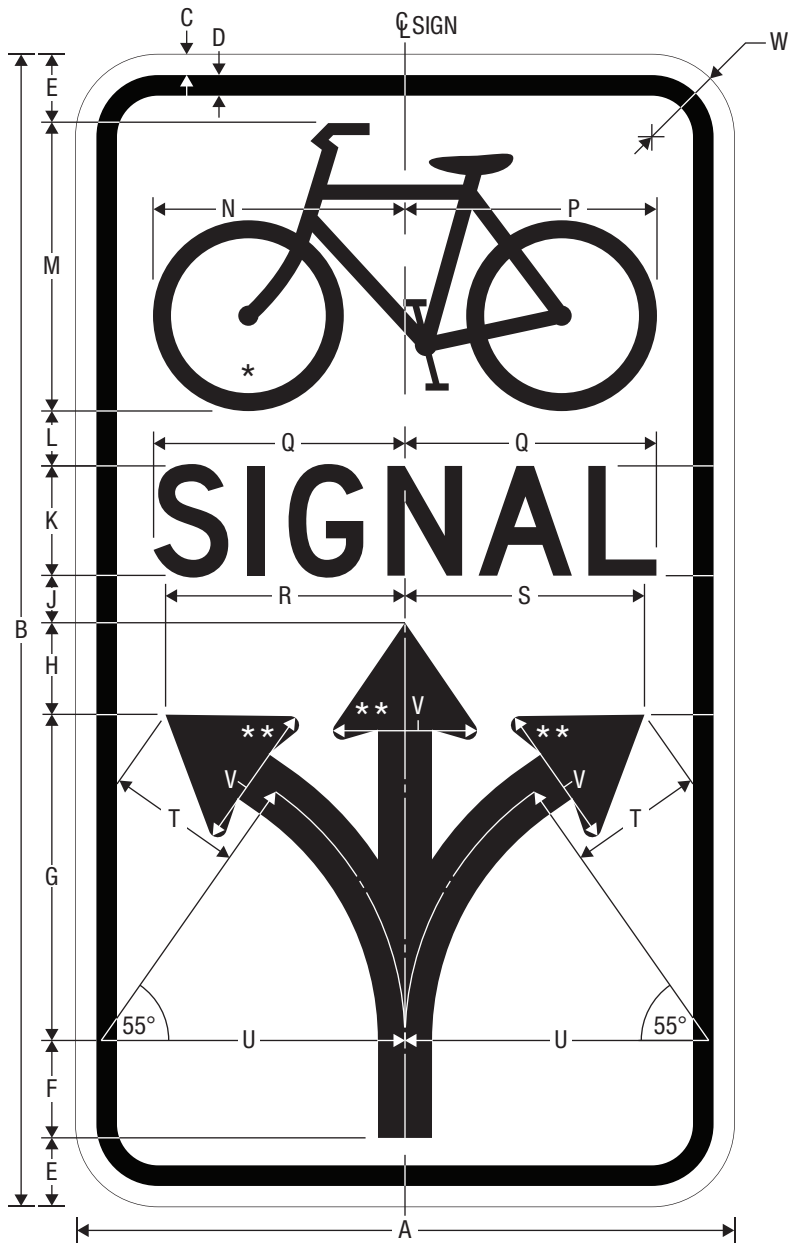

R10-41b

BICYCLE SIGNAL OPTIONAL MOVEMENT (ALL)

\* See page 8-4 for symbol design.

\*\* See page 7-3 for arrow design.

A	B	C	D	E	F	G	H	J	K	L
12	21	0.375	0.375	1.25	1.777	5.940	1.675	0.858	2 D	1
24	36	0.375	0.625	2.5	3.243	10.841	3.058	1.108	3.75 D	1.5

M	N	P	Q	R	S	T	U	V	W
5.25	4.594	4.593	4.583	4.366	4.365	2.450	5.541	2.625	1.5
7.5	6.563	6.562	8.593	7.969	7.968	4.473	10.114	4.75	1.5

COLORS: LEGEND, BORDER — BLACK  
BACKGROUND — WHITE (RETROREFLECTIVE)

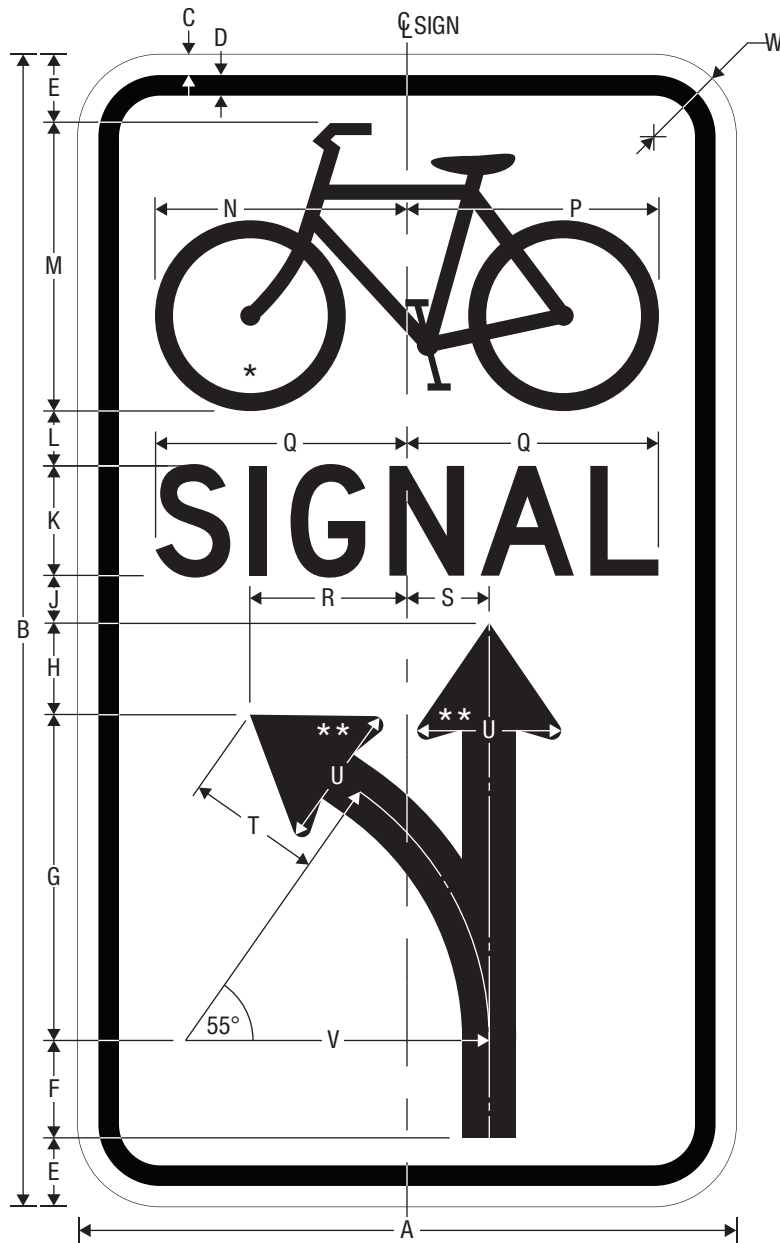

R10-41c

BICYCLE SIGNAL OPTIONAL MOVEMENT (LEFT AND THRU)

\* See page 8-4 for symbol design.

\*\* See page 7-3 for arrow design.

A	B	C	D	E	F	G	H	J	K	L
12	21	0.375	0.375	1.25	1.777	5.940	1.675	0.858	2 D	1
24	36	0.375	0.625	2.5	3.243	10.841	3.058	1.108	3.75 D	1.5

M	N	P	Q	R	S	T	U	V	W
5.25	4.594	4.593	4.583	2.866	1.498	2.449	2.625	5.541	1.5
7.5	6.563	6.562	8.593	5.218	2.75	4.470	4.75	10.114	1.5

COLORS: LEGEND, BORDER — BLACK  
BACKGROUND — WHITE (RETROREFLECTIVE)



R11-2a  
STREET CLOSED

A	B	C	D	E	F	G	H	J	K
48	30	0.625	0.75	5	8 D	4	17.970	19.333	1.875

COLORS: LEGEND, BORDER — BLACK  
BACKGROUND — WHITE (RETROREFLECTIVE)

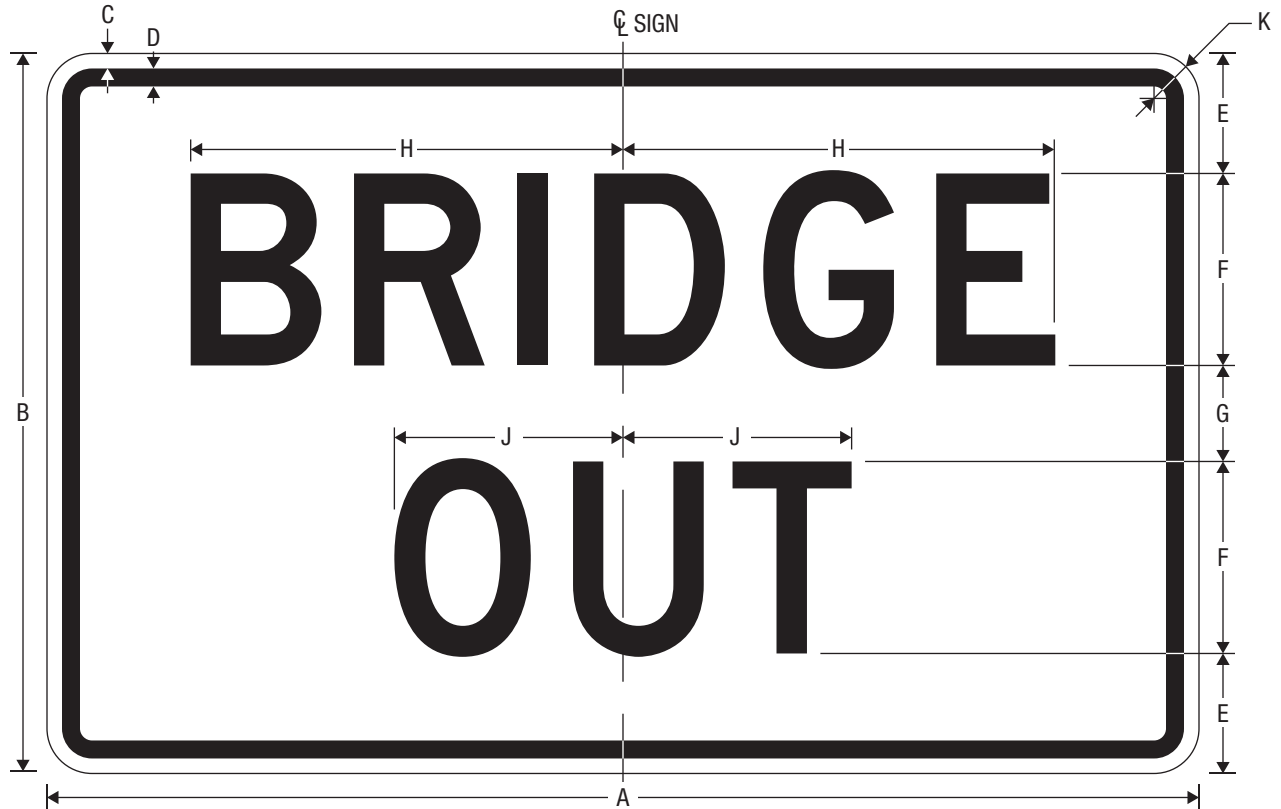

R11-2b  
BRIDGE OUT

A	B	C	D	E	F	G	H	J	K
48	30	0.625	0.75	5	8 D	4	18.013	9.526	1.875

COLORS: LEGEND, BORDER – BLACK  
BACKGROUND – WHITE (RETROREFLECTIVE)



R11-2c  
PATH CLOSED

A	B	C	D	E	F	G	H	J	K
48	30	0.625	0.75	5	8 D	4	12.409	19.333	1.875

COLORS: LEGEND, BORDER — BLACK  
BACKGROUND — WHITE (RETROREFLECTIVE)

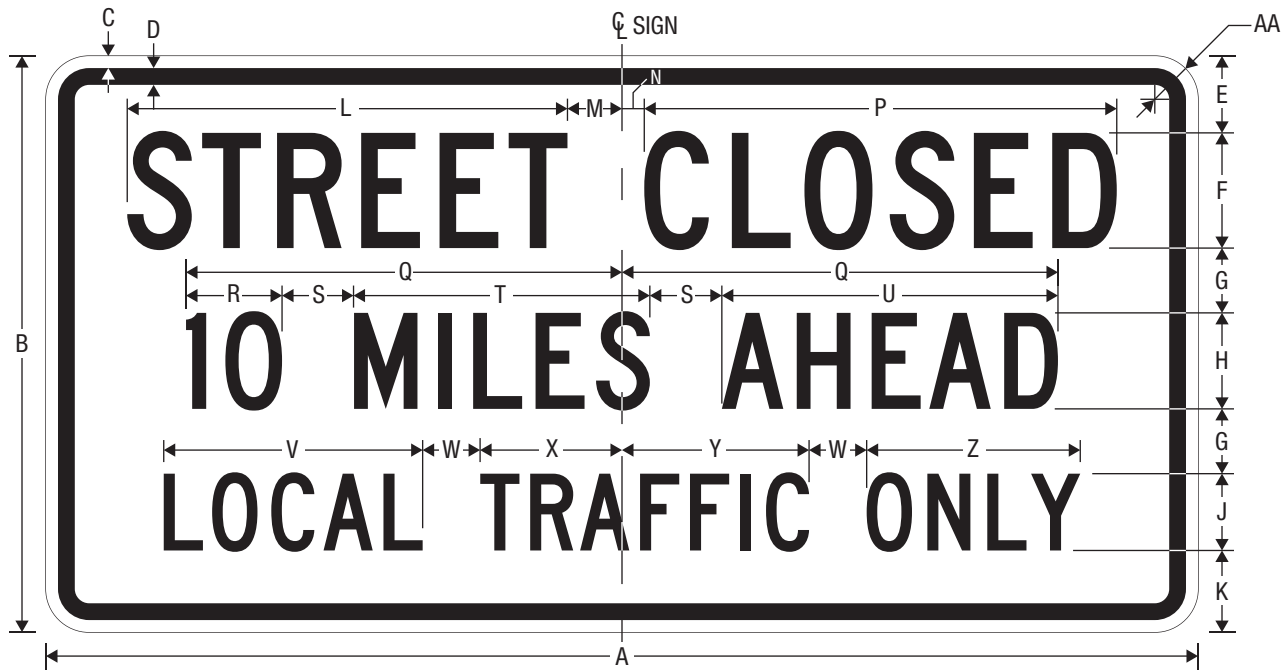

R11-3a

STREET CLOSED - LOCAL TRAFFIC ONLY

\* Optically center about vertical center line.

A	B	C	D	E	F	G	H	J	K	L	M	N
60	30	0.625	0.875	4	6 C	3.375	5 C	4 C	4.25	22.929	2.840	1.160

P	Q	R	S	T	U	V	W	X	Y	Z	AA
24.609	VAR*	VAR	3.75	VAR	17.506	13.485	3	7.383	9.743	11.124	2.25

COLORS: LEGEND, BORDER — BLACK  
BACKGROUND — WHITE (RETROREFLECTIVE)

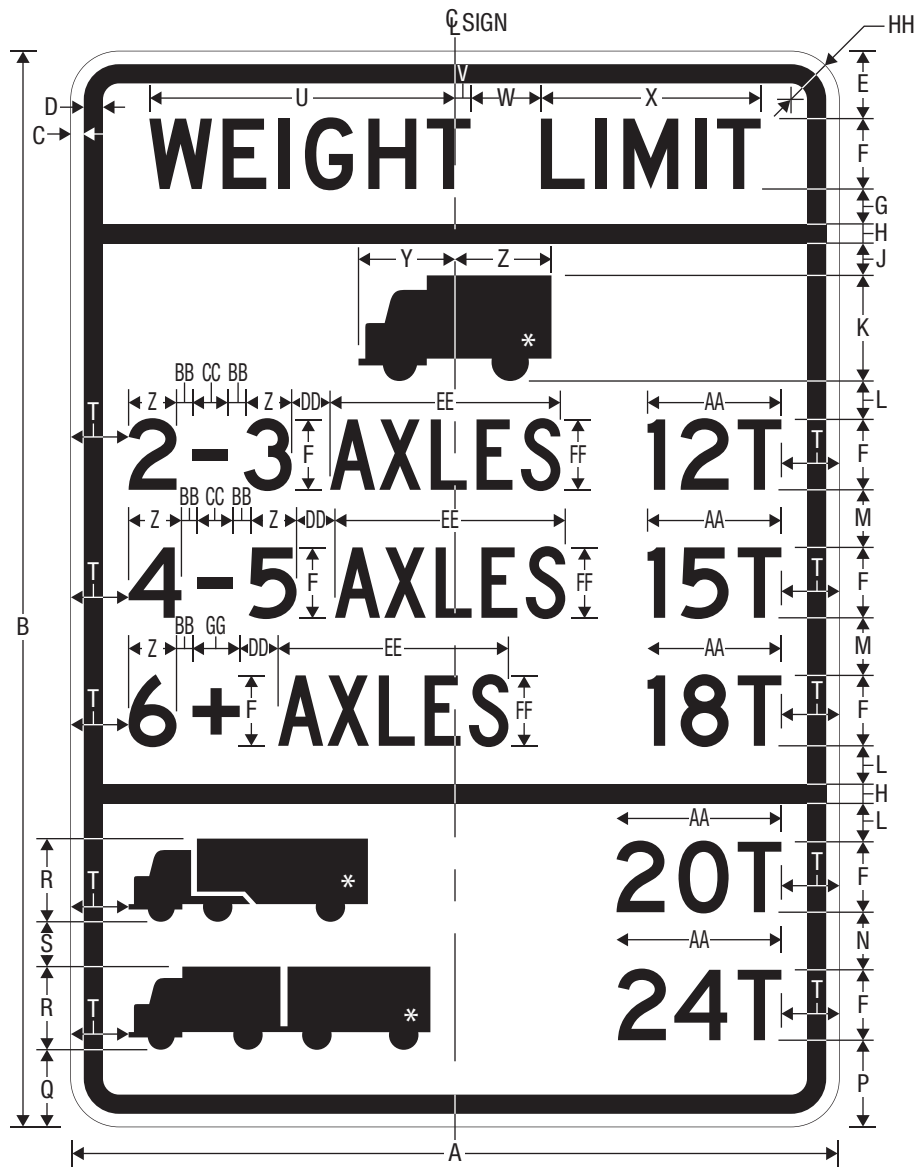

R12-6

WEIGHT LIMIT - SPECIALIZED HAULING VEHICLES

\* See pages 8-1 - 8-3 for symbol designs.

\*\* Reduce Spacing 20%.

A	B	C	D	E	F	G	H	J	K	L	M	N	P	Q	R
30	42	0.5	0.75	2.625	2.75 D	1.375	0.75	1.25	4.125	1.5	2.25	2.25	3.375	3	3.25
36	48	0.625	0.875	3	3.5 D	1.5	0.875	1.125	5	1.75	2	2.375	3	2.75	4
48	60	0.75	1.25	3.75	4.5 D	1.75	1	1.25	6.25	2	2.625	3	3.75	3.25	5.5

S	T	U	V	W	X	Y	Z	AA	BB	CC	DD	EE	FF	GG	HH
1.75	2.25	11.940	0.607	2.75	8.583	3.769	VAR	VAR	0.625	1.375	1.5	8.996	2.75 C	1.844	1.875
1.875	2.625	14.946	1.024	3	10.924	4.569	VAR	VAR	0.875	1.75	1.75	11.127	3.5 C**	2.347	2.25
2	3.5	19.538	0.993	4.5	14.045	5.711	VAR	VAR	1.125	2.25	2.25	14.721	4.5 C	3.017	3

COLORS: LEGEND, BORDER — BLACK  
BACKGROUND — WHITE (RETROREFLECTIVE)

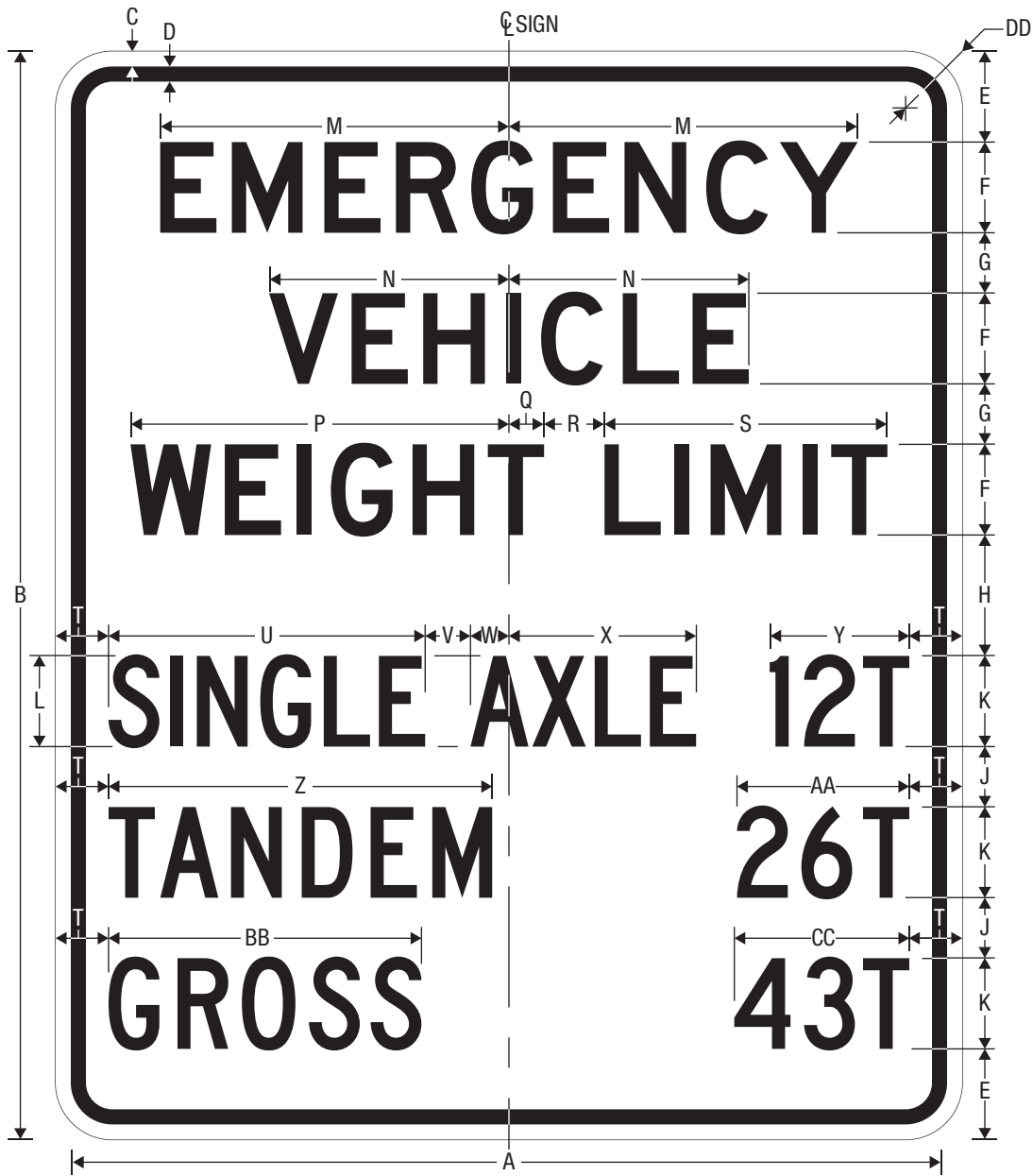

R12-7

WEIGHT LIMIT - EMERGENCY VEHICLES

\* Reduce Spacing 30%.

A	B	C	D	E	F	G	H	J	K	L	M	N	P
30	36	0.5	0.5	3	3 D	2	4	2	3 C	3 C*	11.542	7.939	12.526
48	60	0.75	0.75	5.5	5 D	3.75	6.25	3.375	4.5 C	4.5 C*	19.237	13.232	20.832

Q	R	S	T	U	V	W	X	Y	Z	AA	BB	CC	DD
1.162	2	9.363	1.75	10.477	1.5	1.523	5.944	VAR	12.695	VAR	10.354	VAR	1.875
1.981	3.25	15.605	3.166	15.715	2.5	2.618	8.583	VAR	19.043	VAR	15.531	VAR	3

COLORS: LEGEND, BORDER — BLACK  
BACKGROUND — WHITE (RETROREFLECTIVE)



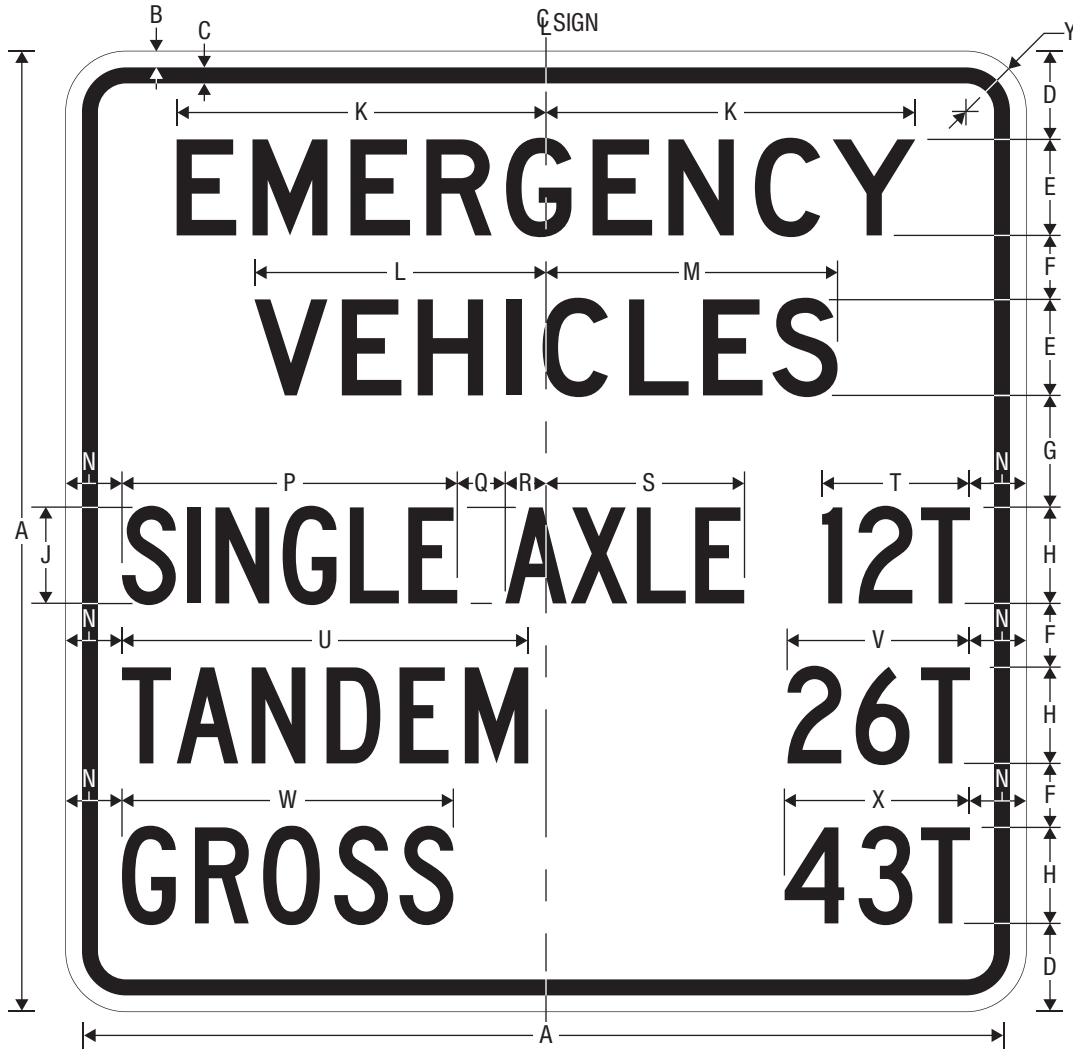

R12-7aP

WEIGHT LIMIT - EMERGENCY VEHICLES (PLAQUE)

\* Reduce Spacing 30%.

A	B	C	D	E	F	G	H	J	K	L	M
30	0.5	0.5	2.75	3 D	2	3.5	3 C	3 C*	11.542	9.111	9.110
48	0.75	0.75	4.25	5 D	3.5	5.5	4.5 C	4.5 C*	19.237	15.184	15.184

N	P	Q	R	S	T	U	V	W	X	Y
1.75	10.477	1.5	1.273	6.194	VAR	12.695	VAR	10.354	VAR	1.875
3.25	15.715	2.5	2.535	8.666	VAR	19.043	VAR	15.531	VAR	3

COLORS: LEGEND, BORDER — BLACK  
BACKGROUND — WHITE (RETROREFLECTIVE)

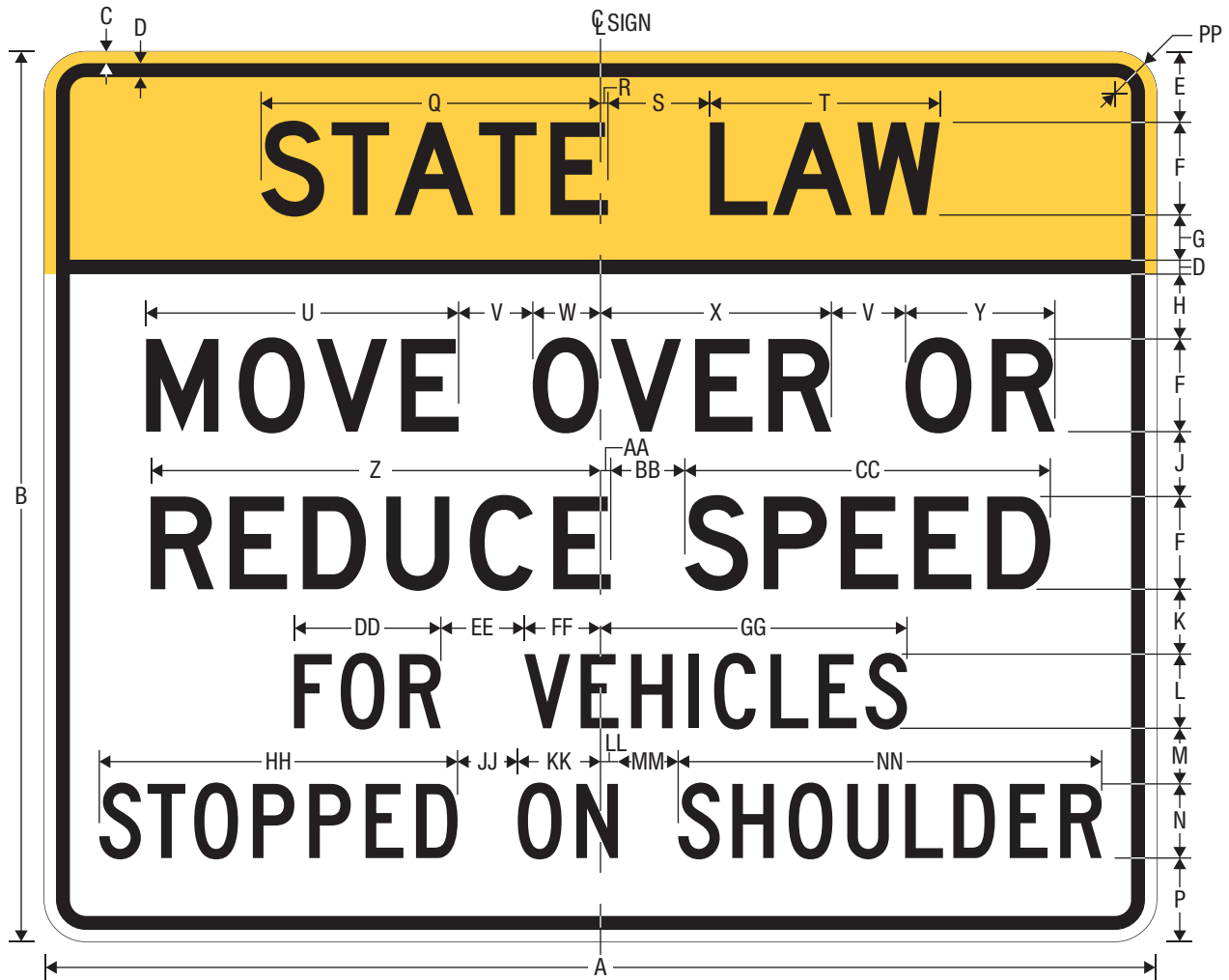

R16-3

MOVE OVER OR REDUCE SPEED

\* Reduce Spacing 10%.

A	B	C	D	E	F	G	H	J	K	L	M	N
60	48	0.625	0.75	3.813	5 D	2.437	3.5	3.5	3.5	4 C	3	4 C
84	60	0.75	1	4.5	7 D	2.5	3.125	5	4.5	5 D	3.75	5 D*
102	72	0.75	1.25	5.25	8 D	3.5	4.25	6	5.5	6 D	4.5	6 D

P	Q	R	S	T	U	V	W	X	Y	Z	AA	BB
4.5	18.308	0.402	5.5	12.406	16.859	4	3.654	12.456	8.056	24.266	0.552	4
4.625	25.282	0.912	7	17.369	23.602	7	5.116	17.438	11.279	34.672	0.073	7
5.75	28.893	1.043	8	19.850	26.974	7	5.846	19.930	12.890	39.625	0.083	8

CC	DD	EE	FF	GG	HH	JJ	KK	LL	MM	NN	PP
19.714	7.923	4.5	4.112	16.535	19.327	3.25	4.462	0.940	3.25	22.848	2.25
27.599	11.808	5	6.780	23.588	27.420	3.75	6.778	1.168	3.75	33.029	3
31.542	14.169	6	8.136	28.305	33.444	5	8.346	1.322	5	40.469	3

COLORS:

UPPER SECTION: LEGEND, BORDER — BLACK  
BACKGROUND — YELLOW (RETROREFLECTIVE)

LOWER SECTION: LEGEND BORDER — BLACK  
BACKGROUND — WHITE (RETROREFLECTIVE)

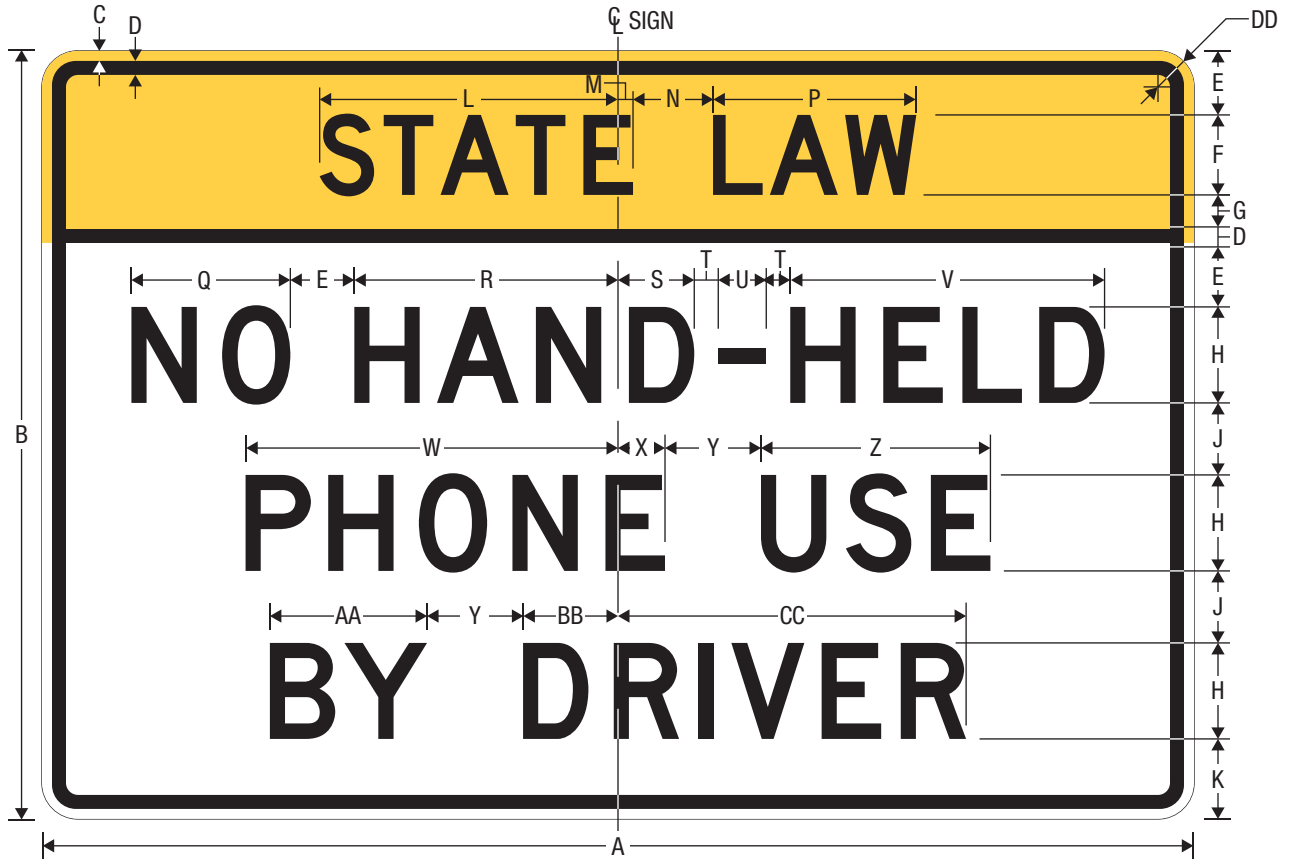

R16-15

NO HAND-HELD PHONE USE BY DRIVER

\* Increase Spacing 50%.  
\*\* Increase Spacing 20%.

A	B	C	D	E	F	G	H	J	K
72	48	0.625	0.875	4	5 D*	2.125	6 D**	4.5	5

L	M	N	P	Q	R	S	T	U
18.646	0.939	5	12.706	9.932	16.479	4.766	1.5	3

V	W	X	Y	Z	AA	BB	CC	DD
19.644	23.277	2.937	6	14.339	9.824	5.933	21.757	2.25

**COLORS:**

UPPER SECTION: LEGEND, BORDER — BLACK  
BACKGROUND — YELLOW (RETROREFLECTIVE)

LOWER SECTION: LEGEND BORDER — BLACK  
BACKGROUND — WHITE (RETROREFLECTIVE)

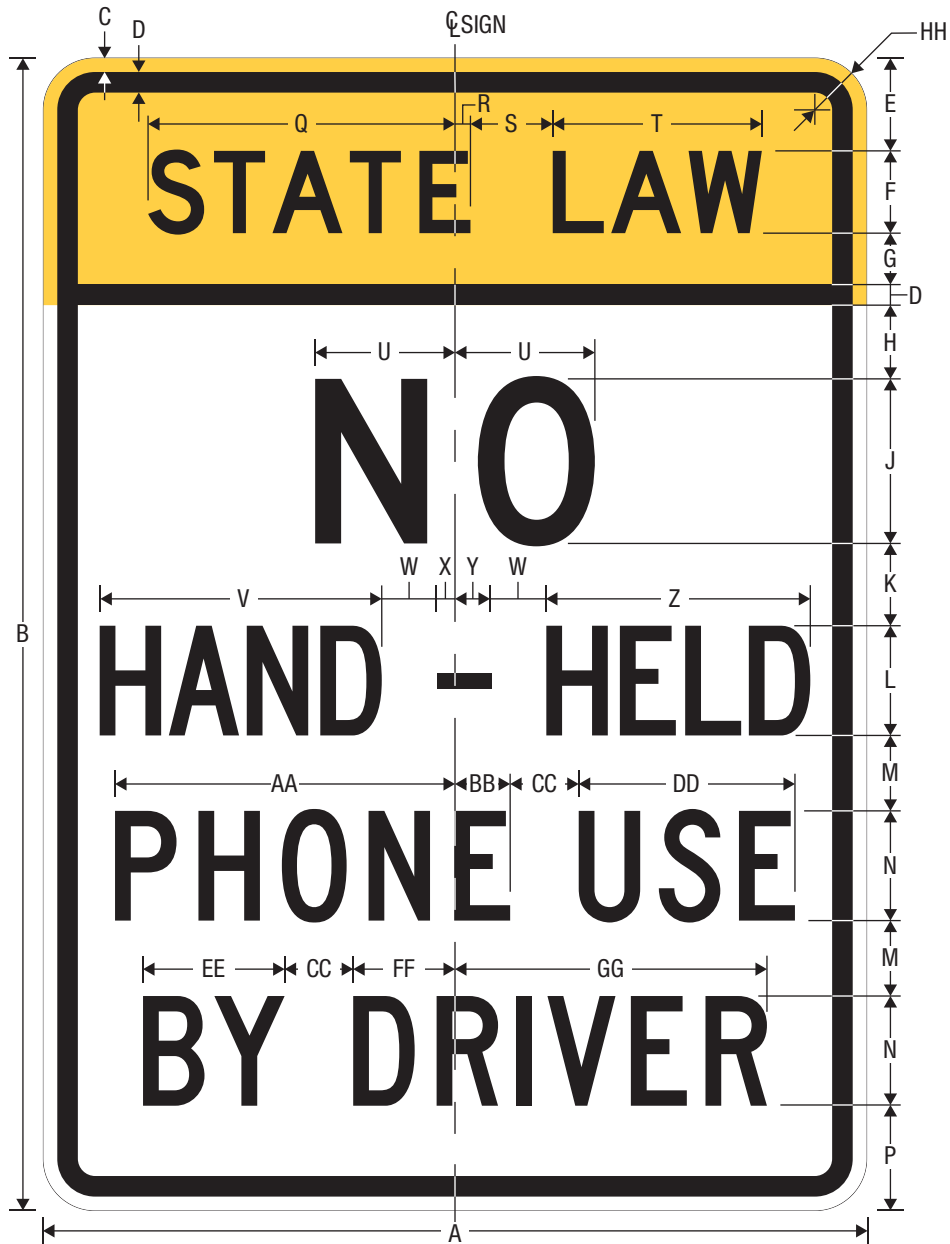

R16-15a

NO HAND-HELD PHONE USE BY DRIVER

\* Increase Spacing 50%.

\*\* Increase Spacing 40%.

† Decrease Spacing 50%.

A	B	C	D	E	F	G	H	J	K	L
30	42	0.5	0.75	3.375	3 D*	1.875	2.688	6 D**	3	4 C†

M	N	P	Q	R	S	T	U	V	W	X
2.75	4 C	3.812	11.188	0.563	3	7.624	5.098	10.284	2	0.670

Y	Z	AA	BB	CC	DD	EE	FF	GG	HH
1.330	9.624	12.394	2.011	2.5	7.883	5.162	3.712	11.373	1.875

UPPER SECTION

COLORS: LEGEND, BORDER — BLACK  
BACKGROUND — YELLOW (RETROREFLECTIVE)

LOWER SECTION

COLORS: LEGEND, BORDER — BLACK  
BACKGROUND — WHITE (RETROREFLECTIVE)



R1-7a  
WAIT ON STOP - GO ON SLOW

\* Reduce Spacing 20%.

A	B	C	D	E	F	G	H	J	K	L
30	36	0.5	0.75	3.375	5 D*	2.5	5 D	1.75	0.75	12.435

M	N	P	Q	R	S	T	U	V	W	X
1.611	3	7.836	7.806	7.805	7.956	2.050	1.950	8.056	8.330	1.875

COLORS: LEGEND, BORDER — BLACK  
BACKGROUND — WHITE (RETROREFLECTIVE)

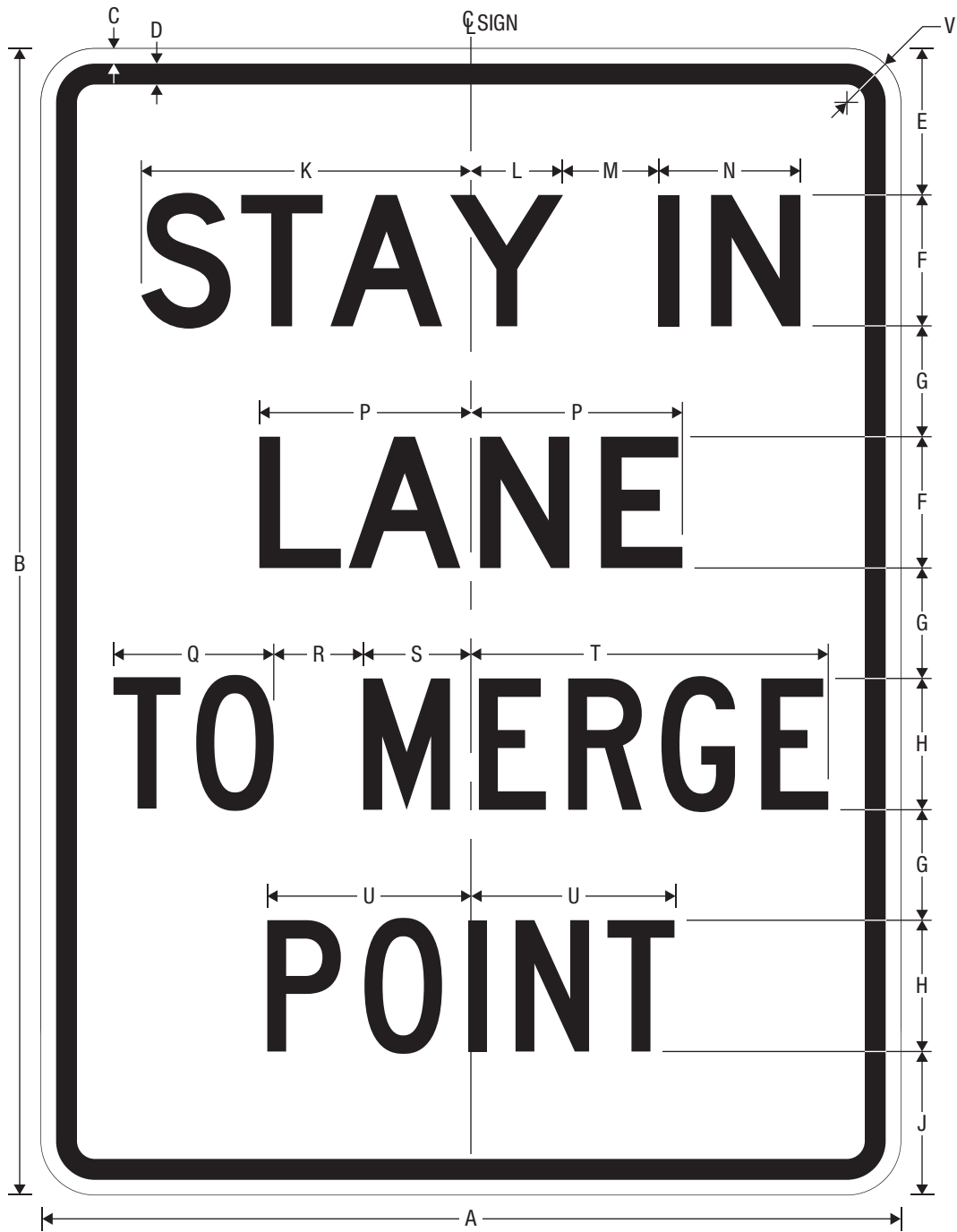

R4-9a  
STAY IN LANE TO MERGE POINT

A	B	C	D	E	F	G	H	J	K
36	48	0.625	0.875	6.125	5.5 D	4.625	5.5 C	6	13.805

L	M	N	P	Q	R	S	T	U	V
3.861	4	5.944	8.860	6.713	3.75	4.508	14.970	8.528	2.25

COLORS: LEGEND, BORDER — BLACK  
BACKGROUND — WHITE (RETROREFLECTIVE)



R9-12  
BIKE LANE CLOSED

A	B	C	D	E	F	G	H	J	K	L	M	N
24	12	0.375	0.625	2.125	3 D	1.75	8.225	1.595	0.155	9.665	7.250	1.5

COLORS: LEGEND, BORDER – BLACK  
BACKGROUND – WHITE (RETROREFLECTIVE)

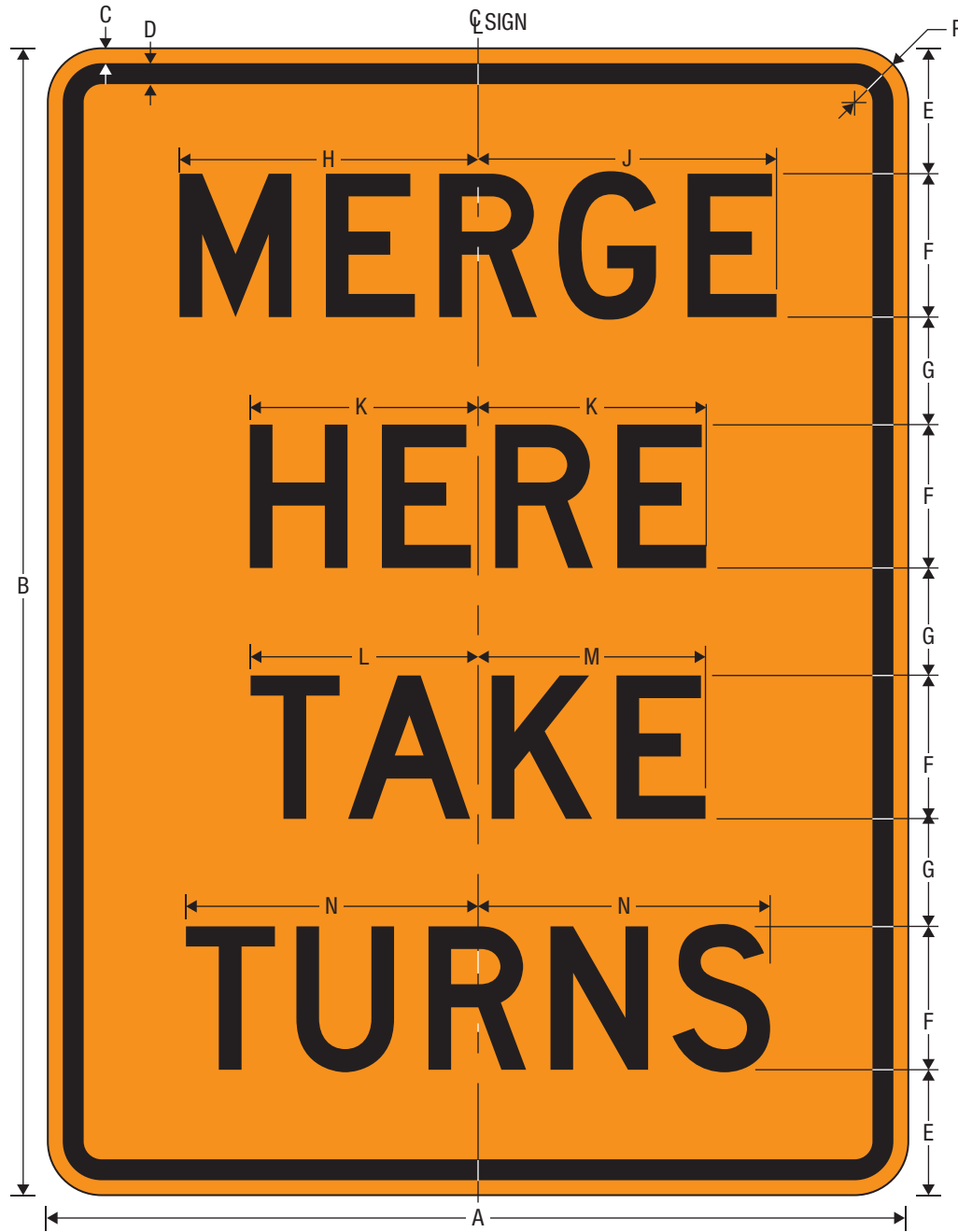

W9-2a  
MERGE HERE TAKE TURNS

A	B	C	D	E	F	G
36	48	0.625	0.875	5.25	6 D	4.5

H	J	K	L	M	N	P
12.488	12.487	9.546	9.515	9.514	12.220	2.25

COLORS: LEGEND, BORDER — BLACK  
BACKGROUND — ORANGE (RETROREFLECTIVE)





W20-1b  
PATH WORK (WITH DISTANCE)

A	B	C	D	E	F	G	H	J	K	L	M	N
30	0.5	0.75	4 D	2.75	2	6.205	6.204	7.005	7.004	8.606	8.605	1.875
36	0.625	0.875	5 D	3.5	2.5	7.756	7.755	8.756	8.755	10.757	10.757	2.25

COLORS: LEGEND, BORDER — BLACK  
BACKGROUND — ORANGE (RETROREFLECTIVE)

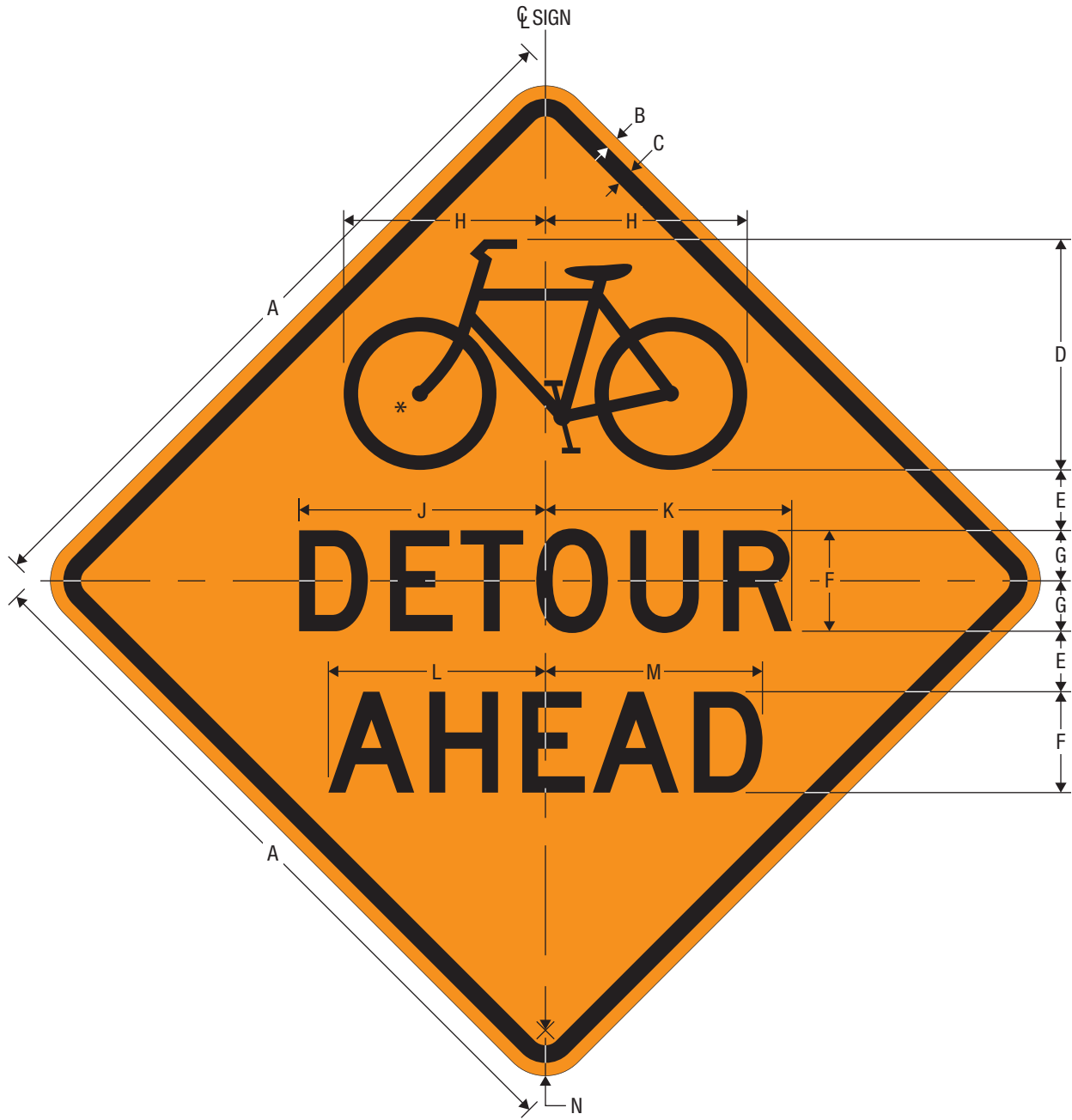

W20-2a  
BIKE DETOUR (WITH DISTANCE)

\* See page 8-4 for symbol design.

A	B	C	D	E	F	G	H	J	K	L	M	N
30	0.5	0.75	9.143	2.5	4 D	2	8	9.767	9.766	8.606	8.605	1.875
36	0.625	0.875	11.429	3	5 D	2.5	10	12.208	12.208	10.757	10.757	2.25

COLORS: LEGEND, BORDER — BLACK  
BACKGROUND — ORANGE (RETROREFLECTIVE)



W20-3a  
PATH CLOSED (WITH DISTANCE)

A	B	C	D	E	F	G	H	J	K	L	M	N	P
30	0.5	0.75	4 D	3	2.75	1.25	6.205	6.204	9.667	9.666	8.606	8.605	1.875
36	0.625	0.875	5 D	3.5	3.25	1.75	7.756	7.755	12.083	12.083	10.757	10.757	2.25

COLORS: LEGEND, BORDER — BLACK  
BACKGROUND — ORANGE (RETROREFLECTIVE)



W20-5b  
BIKE LANE CLOSED (WITH DISTANCE)

A	B	C	D	E	F	G	H	J	K	L	M	N
30	0.5	0.75	4 C	2.25	9.323	2.121	0.879	10.564	8.203	6.753	7.252	1.875
36	0.625	0.875	5 C	2.75	11.654	2.651	1.094	13.205	10.254	8.378	9.128	2.25

COLORS: LEGEND, BORDER — BLACK  
BACKGROUND — ORANGE (RETROREFLECTIVE)

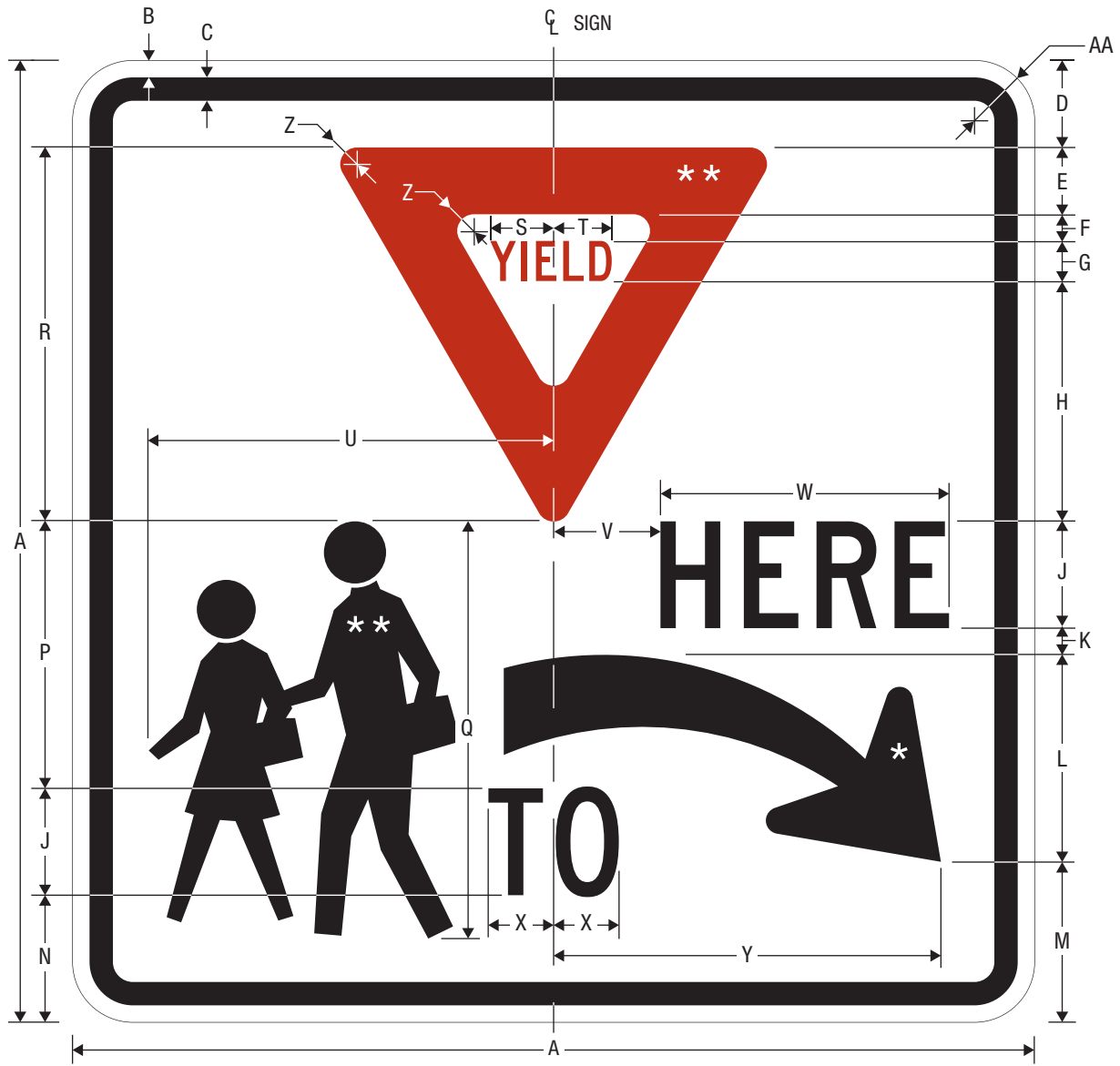

R1-5aR

YIELD HERE TO SCHOOL CROSSING



R1-5aL

\* See page 7-7 for detail.

\*\* See page 8-71 for symbol design.

A	B	C	D	E	F	G	H	J	K	L	M	N
36	0.625	0.875	3.25	2	1	1.5 C	9.5	4 C	1	7.75	6	4.75

P	Q	R	S	T	U	V	W	X	Y	Z	AA
10	15.625	14	2.372	2.175	15.160	4	10.804	2.441	14.5	0.625	2.25

COLORS: LEGEND, BORDER — BLACK  
 BACKGROUND, YIELD SIGN INNER BACKGROUND — WHITE (RETROREFLECTIVE)  
 YIELD SIGN LEGEND AND OUTER BACKGROUND — RED (RETROREFLECTIVE)



R1-5cR

STOP HERE FOR SCHOOL CROSSING



R1-5cL

\* See page 7-7 for detail.

\*\* See page 8-7 for symbol design.

A	B	C	D	E	F	G	H	J	K	L	M
36	0.625	0.875	3	4.25	4.5 C	1.25	4 C	1	7.75	6	4.75

N	P	Q	R	S	T	U	V	W	X	Y	Z
10	15.625	13	5.385	5.920	15.160	4	10.804	2.423	5.5	14.5	2.25

COLORS: LEGEND, BORDER — BLACK (RETROREFLECTIVE)  
 BACKGROUND, STOP SIGN LEGEND — WHITE (RETROREFLECTIVE)  
 STOP SIGN BACKGROUND — RED (RETROREFLECTIVE)

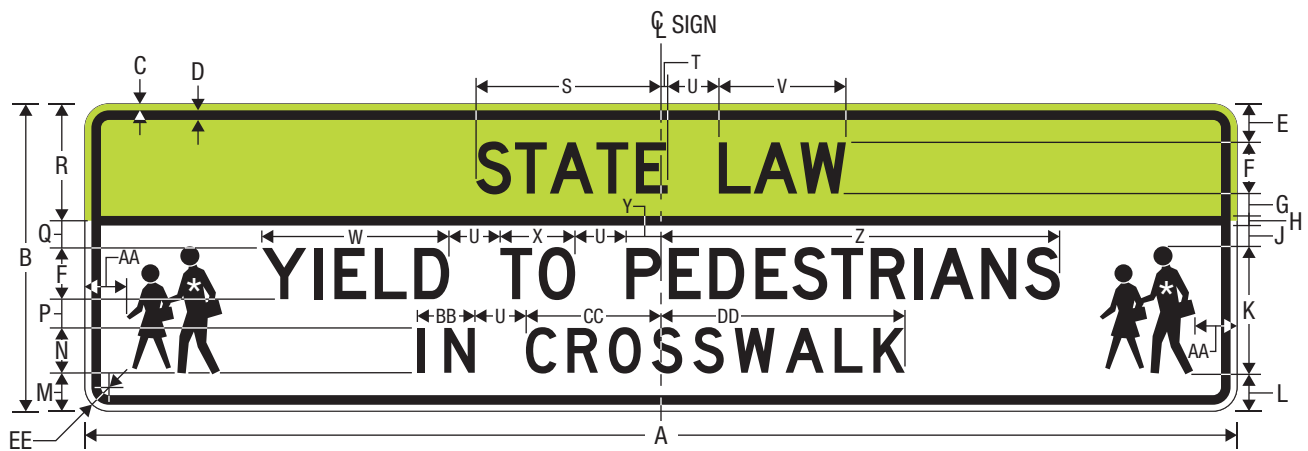

R1-9b  
OVERHEAD SCHOOL CROSSING - YIELD

\* See page 8-71 for symbol design.  
\*\* Increase Spacing 85%.

A	B	C	D	E	F	G	H	J	K
90	24	0.5	0.75	3	4 D	1.75	0.75	1.625	10

L	M	N	P	Q	R	S	T	U	V
2.875	3	3.5 D**	2.25	2.125	9.125	14.447	0.521	4	9.925

W	X	Y	Z	AA	BB	CC	DD	EE
14.607	5.843	2.707	31.156	3.25	4.497	10.550	19.047	1.875

COLORS: LEGEND, BORDER — BLACK  
 UPPER BACKGROUND — FLUORESCENT YELLOW-GREEN (RETROREFLECTIVE)  
 LOWER BACKGROUND — WHITE (RETROREFLECTIVE)

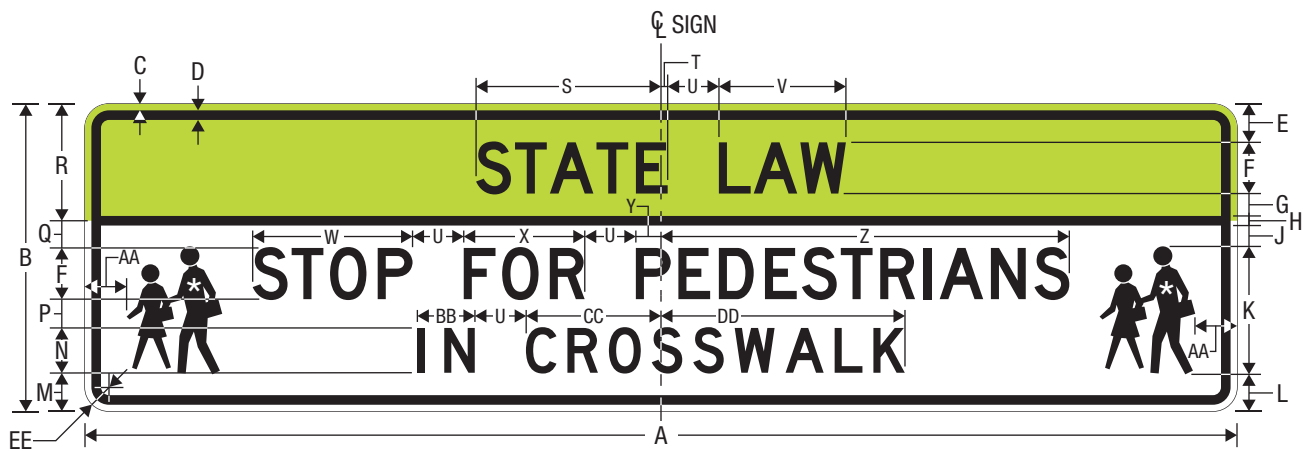

R1-9c  
OVERHEAD SCHOOL CROSSING - STOP

\* See page 8-71 for symbol design.

\*\* Increase Spacing 85%.

A	B	C	D	E	F	G	H	J	K
90	24	0.5	0.75	3	4 D	1.75	0.75	1.625	10

L	M	N	P	Q	R	S	T	U	V
2.875	3	3.5 D**	2.25	2.125	9.125	14.447	0.521	4	9.925

W	X	Y	Z	AA	BB	CC	DD	EE
12.489	9.446	1.964	31.899	3.25	4.497	10.550	19.047	1.875

COLORS: LEGEND, BORDER — BLACK  
 UPPER BACKGROUND — FLUORESCENT YELLOW-GREEN (RETROREFLECTIVE)  
 LOWER BACKGROUND — WHITE (RETROREFLECTIVE)



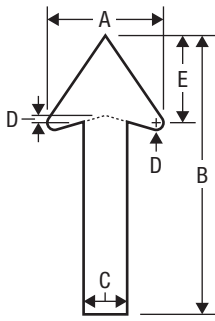

**THROUGH**

U.C. LETTER HEIGHT	A	B	C	D	E
8	8.75	21	3.281	0.547	6.563
10.67	10.625	25.5	3.984	0.664	7.969
13.33	13.333	32	5	0.833	10
16	16.25	39	6.094	1.016	12.188
20	20	48	7.5	1.25	15

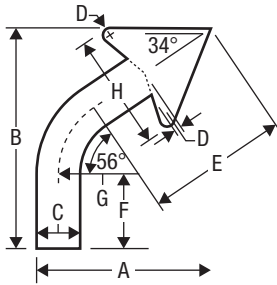

**RIGHT (LEFT) ONLY**

U.C. LETTER HEIGHT	A	B	C	D	E	F	G	H
8	13.125	16.625	3.281	0.547	10.654	5.629	6.016	8.75
10.67	15.938	20.188	3.984	0.664	12.937	6.836	7.305	10.625
13.33	20	25.333	5	0.833	16.235	8.578	9.167	13.333
16	24.375	30.875	6.094	1.016	19.786	10.454	11.172	16.25
20	30	38	7.5	1.25	24.352	12.867	13.75	20

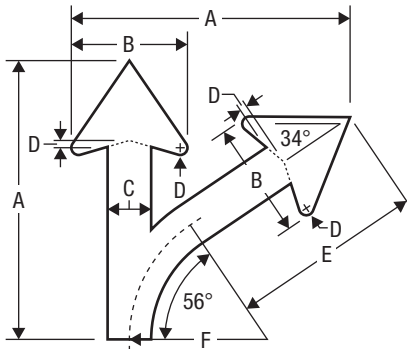

**OPTIONAL DIVERGE - THROUGH WITH RIGHT (LEFT)**

U.C. LETTER HEIGHT	A	B	C	D	E	F
8	21	8.75	3.281	0.547	14.529	10.391
10.67	25.5	10.625	3.984	0.664	17.642	12.617
13.33	32	13.333	5	0.833	22.139	15.833
16	39	16.25	6.094	1.016	26.981	19.297
20	48	20	7.5	1.25	33.208	23.75

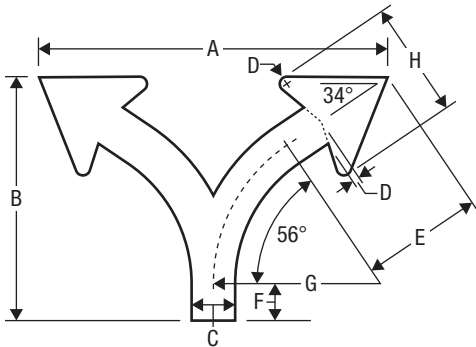

**OPTIONAL SPLIT**

U.C. LETTER HEIGHT	A	B	C	D	E	F	G	H
8	26.25	18.375	3.281	0.547	9.144	2.783	12.578	8.75
10.67	31.875	22.313	3.984	0.664	11.103	3.380	15.273	10.625
13.33	40	28	5	0.833	13.933	4.241	19.167	13.333
16	48.75	34.125	6.094	1.016	16.981	5.169	23.359	16.25
20	60	42	7.5	1.25	20.900	6.362	28.75	20

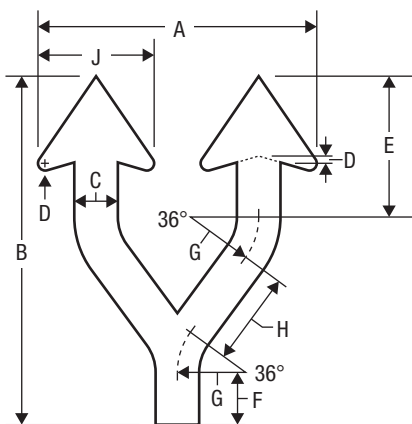

**OPTIONAL SPLIT (OPEN-ROAD ETC)**

U.C. LETTER HEIGHT	A	B	C	D	E	F	G	H	J
16	39	48.75	6.094	1.016	19.577	7.313	9.547	13.148	16.25
20	48	60	7.5	1.25	24.095	9	11.75	16.183	20