

R3-9g

ADVANCE REVERSIBLE LANE CONTROL TRANSITION

A	B	C	D	E	F	G	H	J
108 MIN	36	0.625	0.875	7.5	8 C	5	16.166	6
K	L	M	N	P	Q	R	S	T
21.246	16.288	21.128	VAR	7.263	VAR	VAR	6 C	3

COLORS: LEGEND, BORDER – BLACK  
BACKGROUND – WHITE (RETROREFLECTIVE)

2-80-1

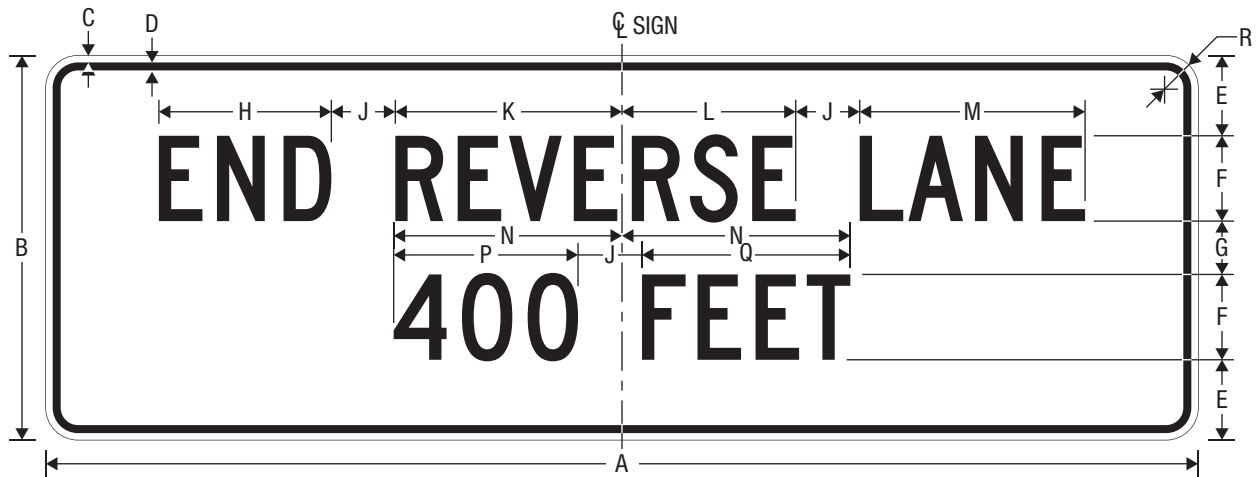

R3-9g

ADVANCE REVERSIBLE LANE CONTROL TRANSITION

A	B	C	D	E	F	G	H
108 MIN	36	0.625	0.875	7.5	8 C	5	16.166

J	K	L	M	N	P	Q	R
6	21.246	16.288	21.128	VAR	VAR	VAR	3

COLORS: LEGEND, BORDER — BLACK  
BACKGROUND — WHITE (RETROREFLECTIVE)

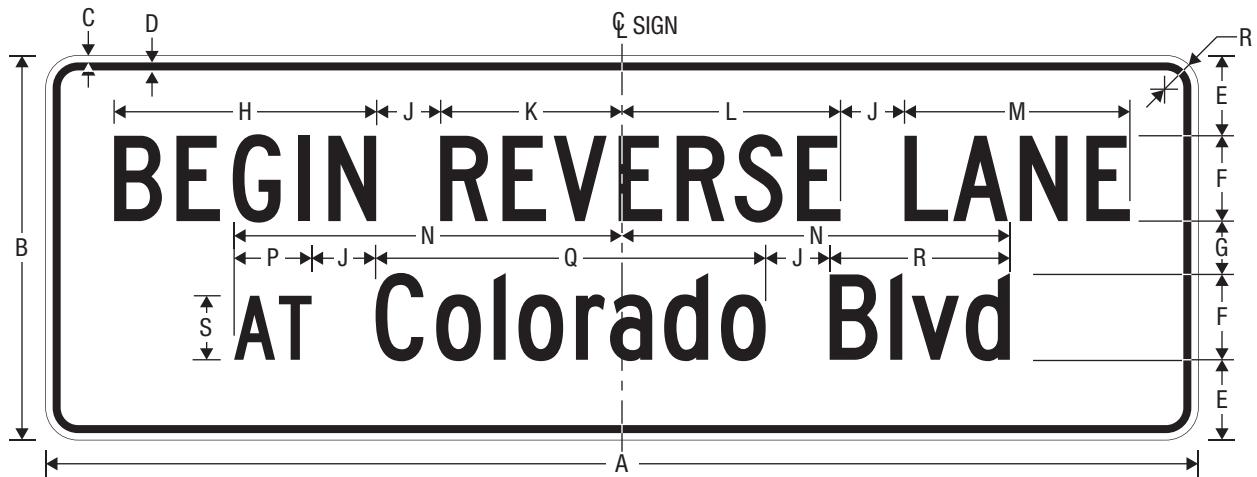

R3-9h

ADVANCE REVERSIBLE LANE CONTROL TRANSITION

A	B	C	D	E	F	G	H	J
108 MIN	36	0.625	0.875	7.5	8 C	5	24.568	6

K	L	M	N	P	Q	R	S	T
17.045	20.489	21.128	VAR	7.263	VAR	VAR	6 C	3

COLORS: LEGEND, BORDER – BLACK  
BACKGROUND – WHITE (RETROREFLECTIVE)

2-81-1

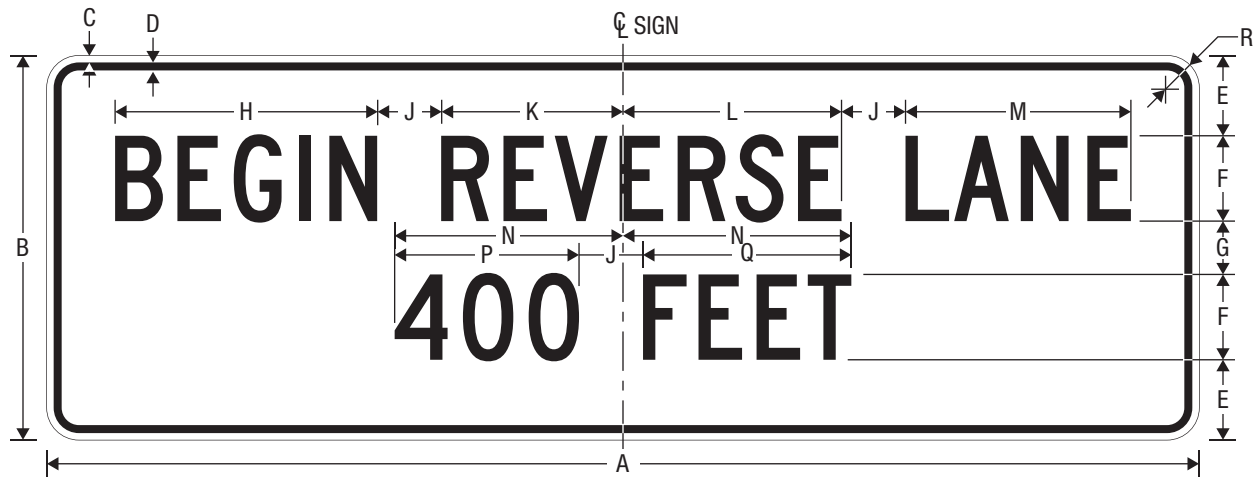

R3-9h

ADVANCE REVERSIBLE LANE CONTROL TRANSITION

A	B	C	D	E	F	G	H
108 MIN	36	0.625	0.875	7.5	8 C	5	24.568

J	K	L	M	N	P	Q	R
6	17.045	20.489	21.128	VAR	VAR	VAR	3

COLORS: LEGEND, BORDER — BLACK  
BACKGROUND — WHITE (RETROREFLECTIVE)



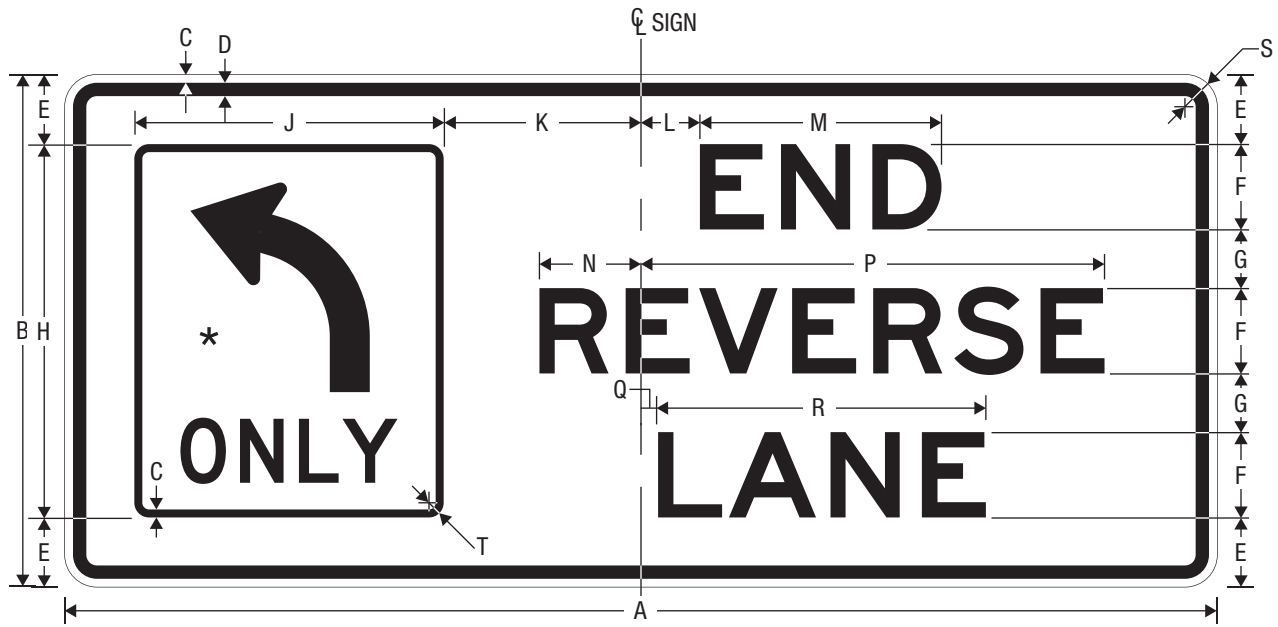

R3-9i  
END REVERSE LANE

\* See R3-5L for design details.

A	B	C	D	E	F	G	H	J
108	48	0.75	1.25	6.5	8 E	5.5	35	29

K	L	M	N	P	Q	R	S	T
18.5	5.524	22.648	9.521	43.455	1.603	30.730	3	1.875

COLORS: LEGEND, BORDER – BLACK  
BACKGROUND – WHITE (RETROREFLECTIVE)

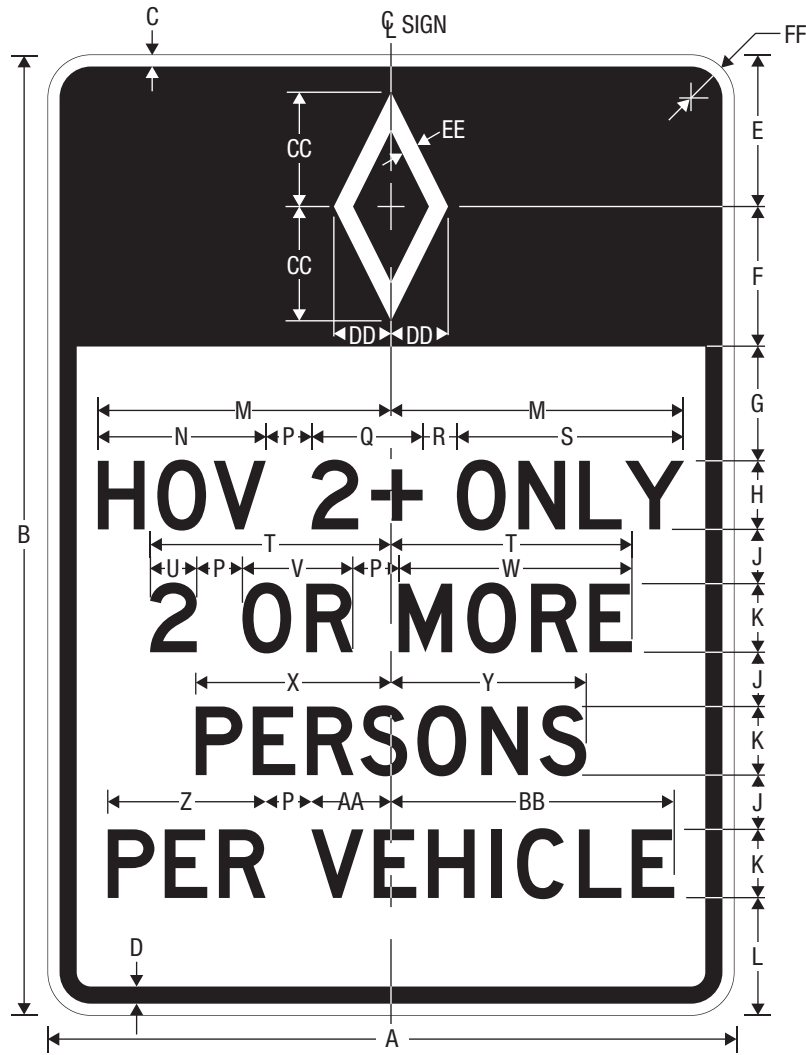

R3-10

PREFERENTIAL LANE VEHICLE OCCUPANCY DEFINITION (POST-MOUNTED)

\* Reduce Spacing 15%.

A	B	C	D	E	F	G	H	J	K
30	42	0.5	0.75	6.625	6.125	5	3 D*	2.375	3 D
36	60	0.625	0.875	9.125	8.5	8.75	3.5 D*	3.5	3.5 D
78	96	0.75	1.25	17	16.25	6.625	7.5 D*	6.5	7.5 D

L	M	N	P	Q	R	S	T	U	V
5.125	VAR	7.348	2	4.860	1.5	9.942	VAR	VAR	4.834
9.125	VAR	8.572	2.5	5.670	2	11.599	VAR	VAR	5.639
6.625	VAR	18.369	5	12.150	3.75	24.855	VAR	VAR	12.084

W	X	Y	Z	AA	BB	CC	DD	EE	FF
10.206	8.542	8.542	6.905	3.486	12.392	5	2.5	0.75	1.875
11.907	9.966	9.965	8.056	3.985	14.540	7	3.5	1.125	2.25
25.515	21.355	21.354	17.263	8.717	30.979	13	6.5	2	3

UPPER SECTION

COLORS: LEGEND — WHITE (RETROREFLECTIVE)  
BACKGROUND — BLACK

LOWER SECTION

COLORS: LEGEND, BORDER — BLACK  
BACKGROUND — WHITE (RETROREFLECTIVE)

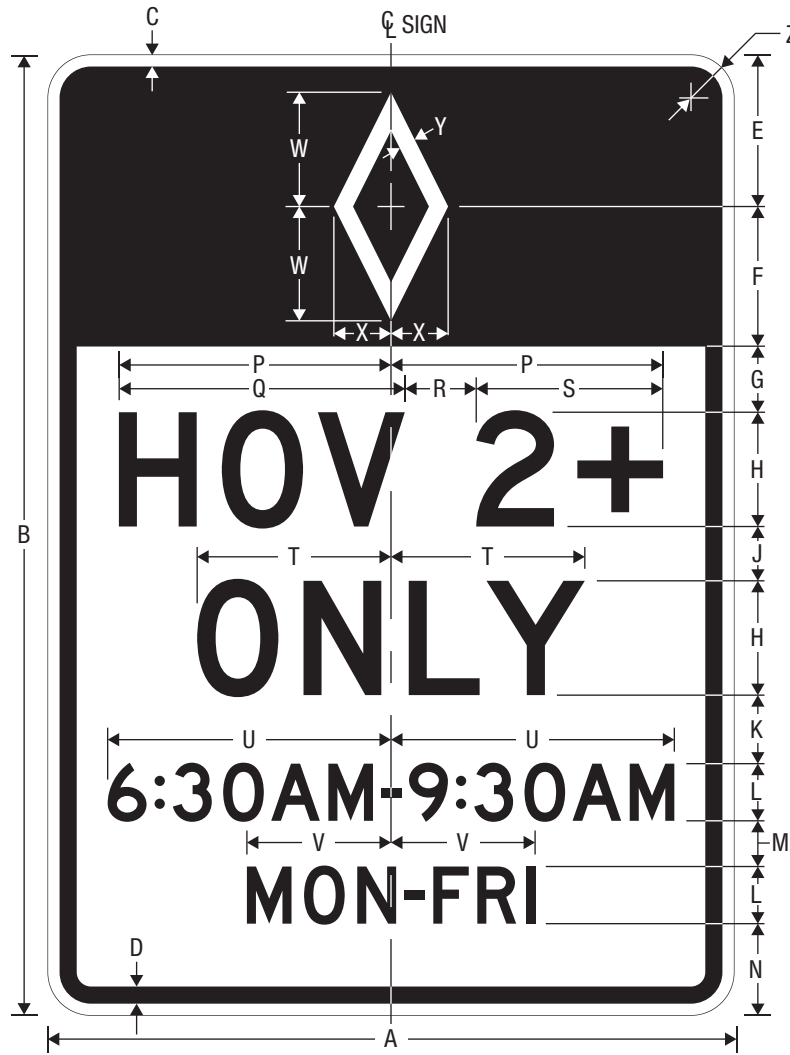

R3-11

PREFERENTIAL LANE OPERATION - HIGH-OCCUPANCY VEHICLES (POST-MOUNTED)

A	B	C	D	E	F	G	H	J	K	L	M
30	42	0.5	0.75	6.625	6.125	2.875	5 D	2.375	3	2.5 D	2
36	60	0.625	0.875	9.125	8.5	5.375	6 D	5	5.125	3 D	3.25
78	96	0.75	1.25	17	16.25	6.25	10 E	7	7.125	5 E	5

N	P	Q	R	S	T	U	V	W	X	Y	Z
4	VAR	11.904	3.125	VAR	8.480	VAR	VAR	5	2.5	0.75	1.875
5.625	VAR	14.286	3.75	VAR	10.176	VAR	VAR	7	3.5	1.125	2.25
7.375	VAR	26.558	6.25	VAR	19.959	VAR	VAR	13	6.5	2	3

UPPER SECTION

COLORS: LEGEND — WHITE (RETROREFLECTIVE)  
BACKGROUND — BLACK

LOWER SECTION

COLORS: LEGEND, BORDER — BLACK  
BACKGROUND — WHITE (RETROREFLECTIVE)



R3-11a

PREFERENTIAL LANE OPERATION - HIGH-OCCUPANCY VEHICLES (POST-MOUNTED)

A	B	C	D	E	F	G	H	J	K	L
30	42	0.5	0.75	2.625	3 D	2	2.125	2.875	5 D	2.375
36	60	0.625	0.875	3.625	4 D	3	3	5.375	6 D	5
78	96	0.75	1.25	6.25	8 E	5.5	5.5	6.25	10 E	7

M	N	P	Q	R	S	T	U	V	W	X
3	2.5 D	2	4	6.125	6.625	1.229	7.354	1.770	7.895	5
5.125	3 D	3.25	5.625	8.5	9.125	1.472	9.972	2.194	10.693	7
7.125	5 E	5	7.375	16.25	17	5.050	22.550	6.615	24.115	13

Y	Z	AA	BB	CC	DD	EE	FF	GG	HH	JJ
2.5	0.75	10.875	VAR	12.509	3.125	VAR	8.480	VAR	VAR	1.875
3.5	1.125	12.375	VAR	15.011	3.75	VAR	10.176	VAR	VAR	2.25
6.5	2	28	VAR	29.415	6.25	VAR	19.959	VAR	VAR	3

UPPER SECTION

COLORS: LEGEND — WHITE (RETROREFLECTIVE)  
BACKGROUND — BLACK

LOWER SECTION

COLORS: LEGEND, BORDER — BLACK  
BACKGROUND — WHITE (RETROREFLECTIVE)

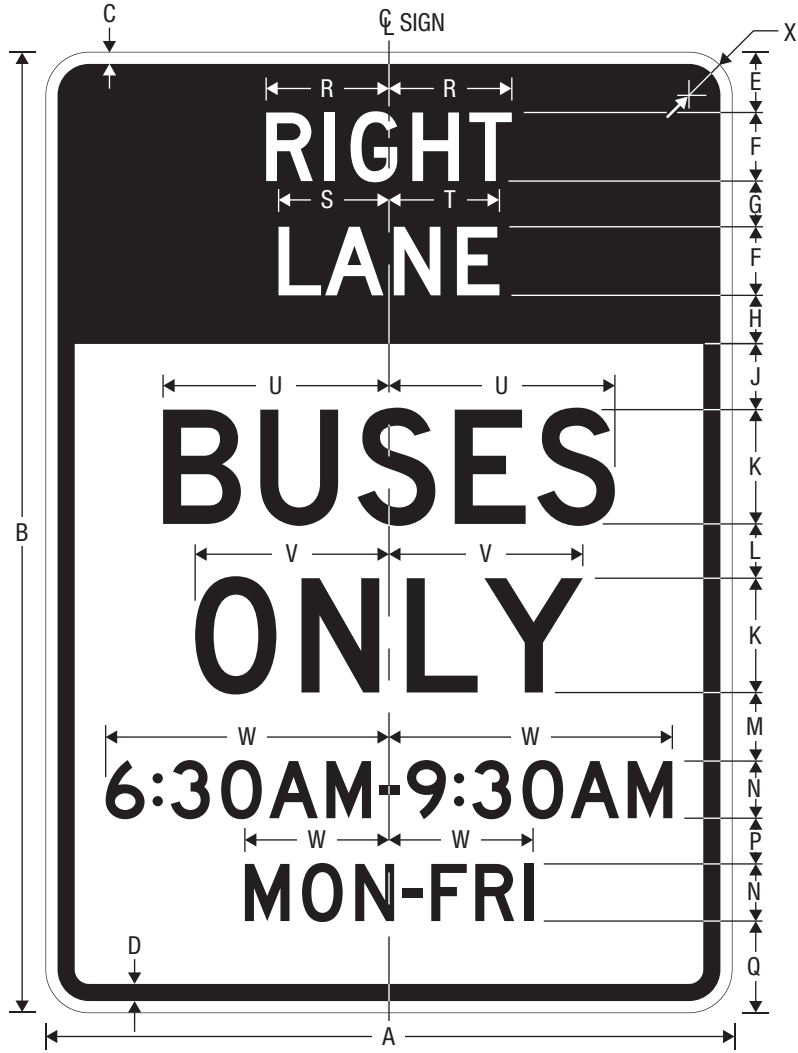

R3-11d

PREFERENTIAL LANE OPERATION (POST-MOUNTED)

A	B	C	D	E	F	G	H	J	K	L
30	42	0.5	0.75	2.625	3 D	2	2.125	2.875	5 D	2.375
36	60	0.625	0.875	3.625	4 D	3	3.125	5.25	6 D	5
78	96	0.75	1.25	6.25	8 E	5.5	5.5	6.25	10 E	7

M	N	P	Q	R	S	T	U	V	W	X
3	2.5 D	2	4	5.374	4.833	4.832	9.883	8.480	VAR	1.875
5.125	3 D	3.25	5.625	7.165	6.444	6.443	11.860	10.176	VAR	2.25
7.125	5 E	5	7.375	16.766	15.365	15.365	23.660	19.959	VAR	3

UPPER SECTION

COLORS: LEGEND — WHITE (RETROREFLECTIVE)  
BACKGROUND — BLACK

LOWER SECTION

COLORS: LEGEND, BORDER — BLACK  
BACKGROUND — WHITE (RETROREFLECTIVE)

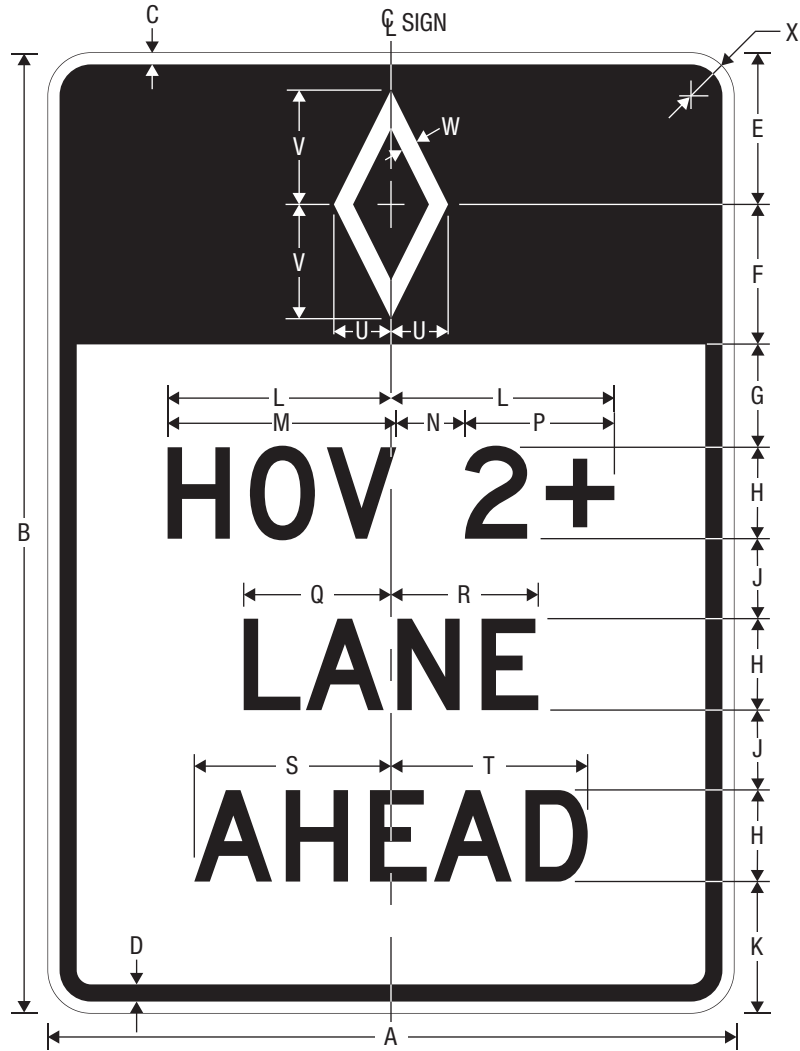

R3-12

PREFERENTIAL LANE AHEAD - HIGH-OCCUPANCY VEHICLES (POST-MOUNTED)

A	B	C	D	E	F	G	H	J	K	L
30	42	0.5	0.75	6.625	6.125	4.5	4 D	3.5	5.75	VAR
36	60	0.625	0.875	9.125	8.5	6.5	6 D	5	7.875	VAR
48	84	0.75	1.25	13.75	13	8.625	8 D	7	10.625	VAR

M	N	P	Q	R	S	T	U	V	W	X
10.007	3	5.925	6.444	6.443	8.606	8.605	2.5	5	0.75	1.875
15.011	4	8.888	9.666	9.665	12.909	12.908	3.5	7	1.125	2.25
20.014	6	11.850	12.887	12.887	17.211	17.211	5.5	11	1.75	3

UPPER SECTION

COLORS: LEGEND — WHITE (RETROREFLECTIVE)  
BACKGROUND — BLACK

LOWER SECTION

COLORS: LEGEND, BORDER — BLACK  
BACKGROUND — WHITE (RETROREFLECTIVE)

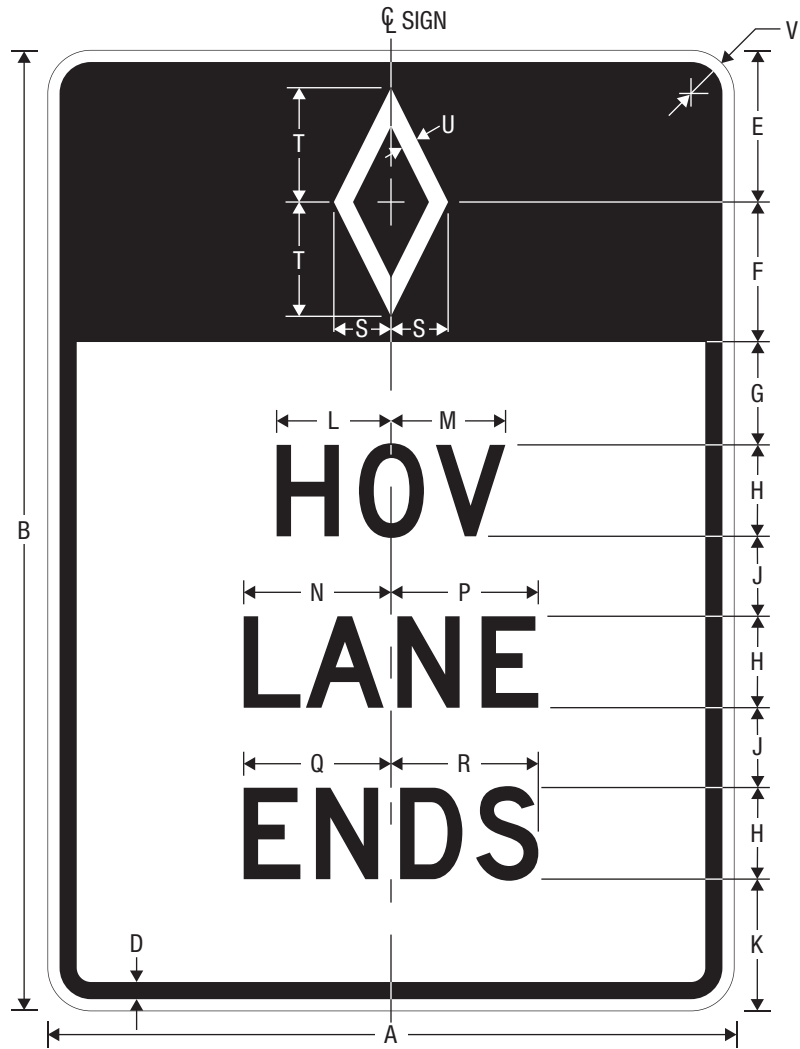

R3-12a

PREFERENTIAL LANE ENDS - HIGH-OCCUPANCY VEHICLES (POST-MOUNTED)

A	B	C	D	E	F	G	H	J	K
30	42	0.5	0.75	6.625	6.125	4.5	4 D	3.5	5.75
36	60	0.625	0.875	9.125	8.5	6.5	6 D	5	7.875
48	84	0.75	1.25	13.75	13	8.625	8 D	7	10.625

L	M	N	P	Q	R	S	T	U	V
5.004	5.003	6.444	6.443	6.445	6.445	2.5	5	0.75	1.875
7.506	7.505	9.666	9.665	9.668	9.667	3.5	7	1.125	2.25
10.007	10.007	12.887	12.887	12.890	12.890	5.5	11	1.75	3

UPPER SECTION

COLORS: LEGEND — WHITE (RETROREFLECTIVE)  
BACKGROUND — BLACK

LOWER SECTION

COLORS: LEGEND, BORDER — BLACK  
BACKGROUND — WHITE (RETROREFLECTIVE)

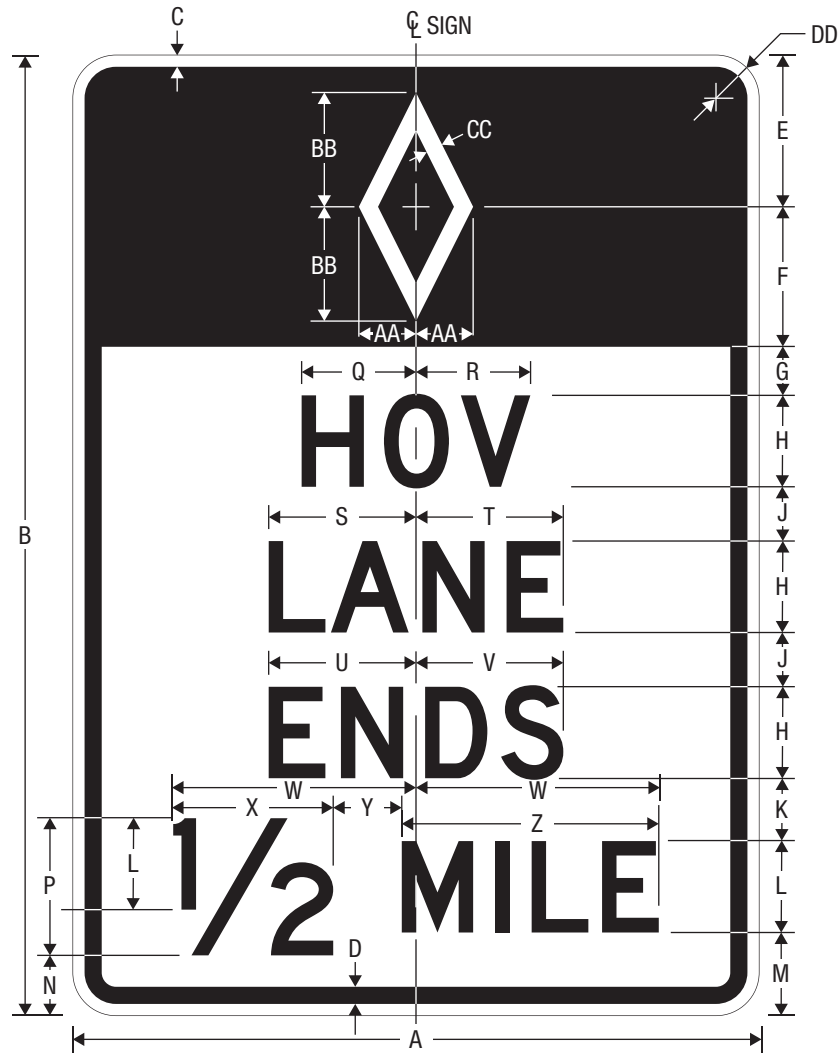

R3-12b

PREFERENTIAL LANE ENDS - HIGH-OCCUPANCY VEHICLES (POST-MOUNTED)

A	B	C	D	E	F	G	H	J	K
30	42	0.5	0.75	6.625	6.125	2.125	4 D	2.375	2.75
36	60	0.625	0.875	9.125	8.5	3.375	6 D	3.75	3.875
48	84	0.75	1.25	13.75	13	4.5	8 D	5	5.25

L	M	N	P	Q	R	S	T	U
4 D	3.625	2.625	6	5.004	5.003	6.444	6.443	6.445
5 D	4.625	3.375	7.5	7.506	7.505	9.666	9.665	9.668
7 D	6.5	4.75	10.5	10.007	10.007	12.887	12.887	12.890

V	W	X	Y	Z	AA	BB	CC	DD
6.445	VAR	VAR	3	11.244	2.5	5	0.75	1.875
9.667	VAR	VAR	3.75	14.055	3.5	7	1.125	2.25
12.890	VAR	VAR	5.25	19.677	5.5	11	1.75	3

UPPER SECTION

COLORS: LEGEND — WHITE (RETROREFLECTIVE)  
BACKGROUND — BLACK

LOWER SECTION

COLORS: LEGEND, BORDER — BLACK  
BACKGROUND — WHITE (RETROREFLECTIVE)



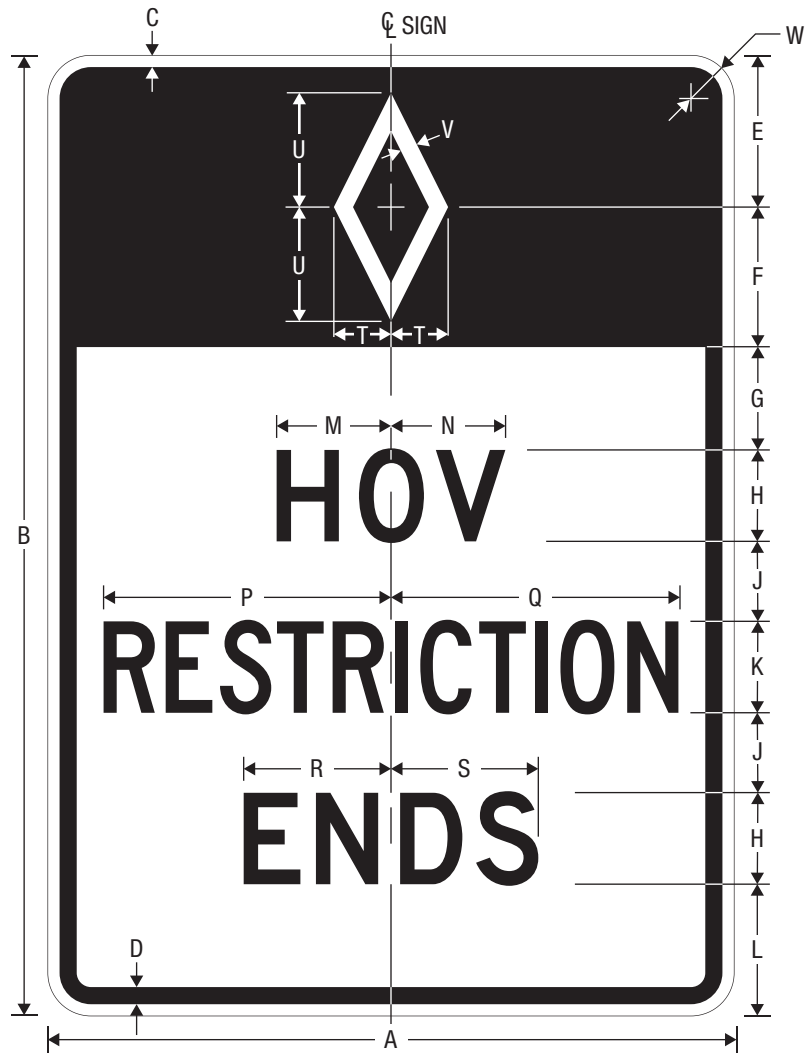

R3-12c

PREFERENTIAL LANE RESTRICTION ENDS - HIGH-OCCUPANCY VEHICLES (POST-MOUNTED)

\* Reduce Spacing 30%.

A	B	C	D	E	F	G	H	J	K	L
30	42	0.5	0.75	6.625	6.125	4.5	4 D	3.5	4 C*	5.75
36	60	0.625	0.875	9.125	8.5	6.5	6 D	5	6 B*	7.875
48	84	0.75	1.25	13.75	13	8.625	8 D	7	8 B*	10.625

M	N	P	Q	R	S	T	U	V	W
5.004	5.003	12.575	12.574	6.445	6.445	2.5	5	0.75	1.875
7.506	7.505	15.103	15.103	9.668	9.667	3.5	7	1.125	2.25
10.007	10.007	20.137	20.137	12.890	12.890	5.5	11	1.75	3

UPPER SECTION

COLORS: LEGEND — WHITE (RETROREFLECTIVE)  
BACKGROUND — BLACK

LOWER SECTION

COLORS: LEGEND, BORDER — BLACK  
BACKGROUND — WHITE (RETROREFLECTIVE)



R3-12d

PREFERENTIAL LANE RESTRICTION ENDS - HIGH-OCCUPANCY VEHICLES (POST-MOUNTED)

\* Reduce Spacing 30%.

A	B	C	D	E	F	G	H	J	K
30	42	0.5	0.75	6.625	6.125	2.125	4 D	2.375	4 C*
36	60	0.625	0.875	9.125	8.5	3.375	6 D	3.75	6 B*
48	84	0.75	1.25	13.75	13	4.5	8 D	5	8 B*

L	M	N	P	Q	R	S	T	U	V
2.75	4 D	3.625	2.625	6	5.004	5.003	12.575	12.574	6.445
3.875	5 D	4.625	3.375	7.5	7.506	7.505	15.103	15.103	9.668
5.25	7 D	6.5	4.75	10.5	10.007	10.007	20.137	20.137	12.890

W	X	Y	Z	AA	BB	CC	DD	EE
6.445	VAR	VAR	3	VAR	2.5	5	.75	1.875
9.667	VAR	VAR	3.75	VAR	3.5	7	1.125	2.25
12.890	VAR	VAR	5.25	VAR	5.5	11	1.75	3

UPPER SECTION

COLORS: LEGEND — WHITE (RETROREFLECTIVE)  
BACKGROUND — BLACK

LOWER SECTION

COLORS: LEGEND, BORDER — BLACK  
BACKGROUND — WHITE (RETROREFLECTIVE)

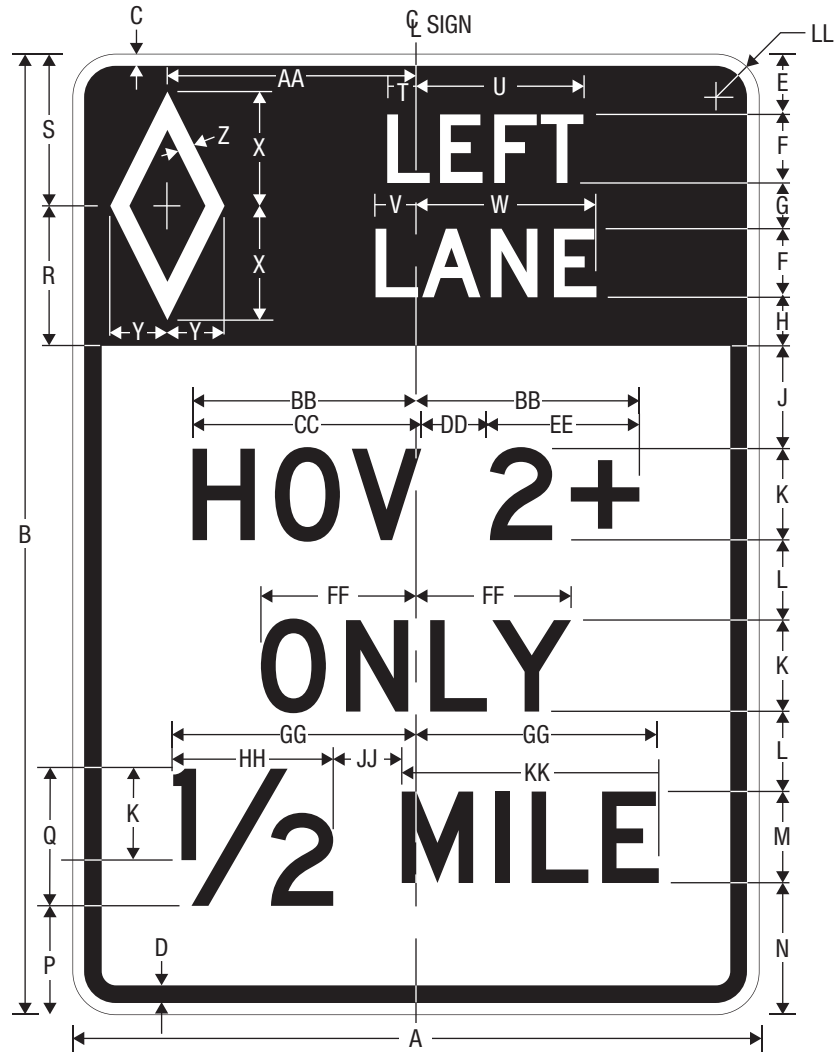

R3-12e

PREFERENTIAL LANE AHEAD- HIGH-OCCUPANCY VEHICLES (POST-MOUNTED)

A	B	C	D	E	F	G	H	J	K	L	M
30	42	0.5	0.75	2.625	3 D	2	2.125	4.5	4 D	3.5	4 D
36	60	0.625	0.875	3.625	4 D	3	3	6	6 D	6	5 D
48	84	0.75	1.25	5.5	6 D	4.5	4.75	7.5	8 D	8	7 D

N	P	Q	R	S	T	U	V	W	X	Y	Z
5.75	4.75	6	6.125	6.625	1.259	7.324	1.770	7.895	5	2.5	0.75
7.375	6.125	7.5	8.5	9.125	1.472	9.972	2.194	10.693	7	3.5	1.125
10.5	8.75	10.5	13	13.75	1.583	15.583	2.666	16.665	11	5.5	1.75

AA	BB	CC	DD	EE	FF	GG	HH	JJ	KK	LL
10.875	VAR	9.466	3	5.925	6.784	VAR	VAR	3	VAR	1.875
12.375	VAR	13.949	4	8.888	10.176	VAR	VAR	3.75	VAR	2.25
14.75	VAR	18.932	6	11.850	13.568	VAR	VAR	5.25	VAR	3

UPPER SECTION

COLORS: LEGEND — WHITE (RETROREFLECTIVE)  
BACKGROUND — BLACK

LOWER SECTION

COLORS: LEGEND, BORDER — BLACK  
BACKGROUND — WHITE (RETROREFLECTIVE)

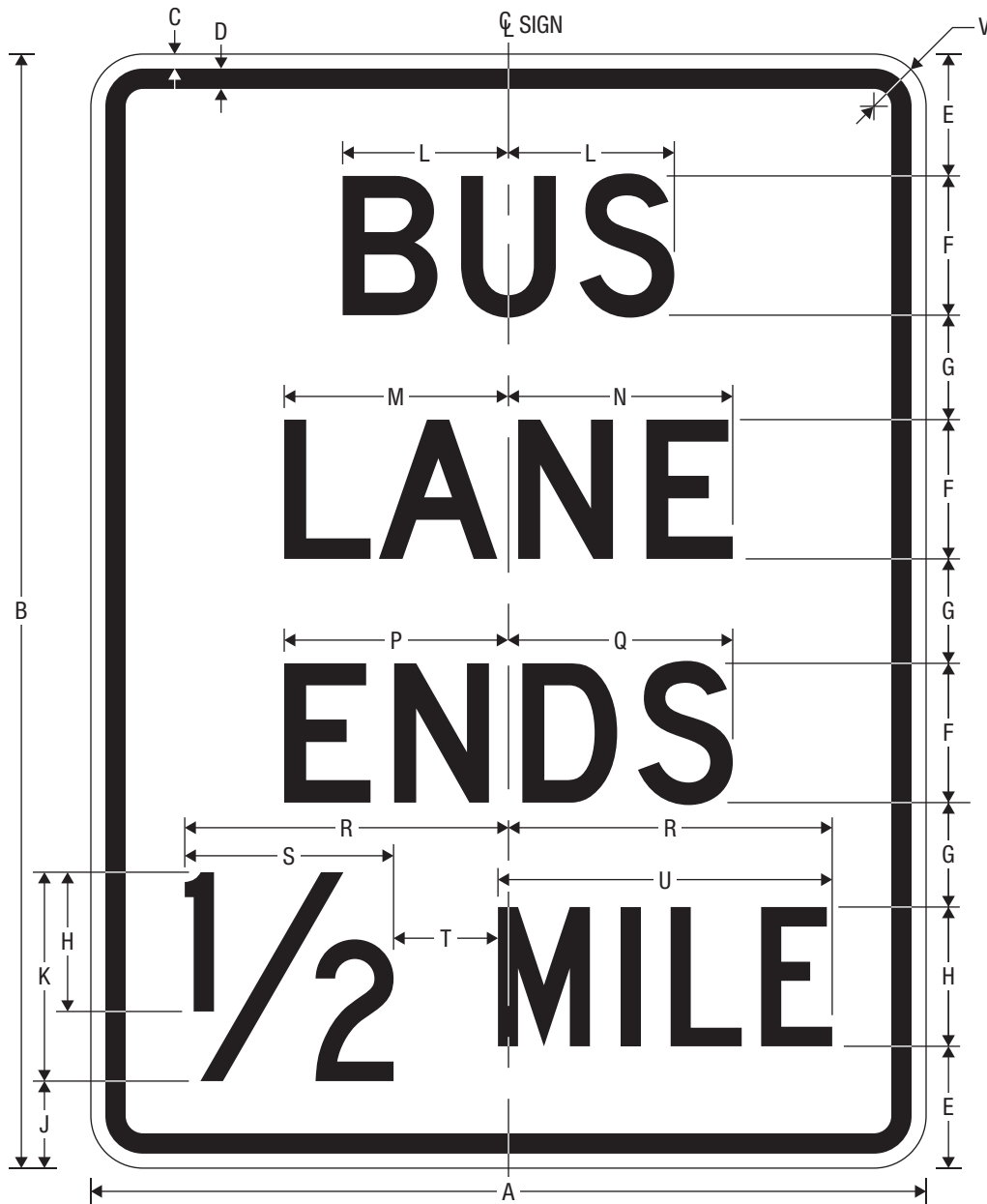

R3-12h  
PREFERENTIAL LANE ENDS (POST-MOUNTED)

A	B	C	D	E	F	G	H	J	K
36	48	0.625	0.875	5.25	6 D	4.5	6 C	3.75	9
48	66	0.75	1.25	8	8 D	6	8 C	6	12
60	84	0.75	1.25	10	10 D	8	10 C	7.5	15

L	M	N	P	Q	R	S	T	U	V
7.147	9.666	9.665	9.668	9.667	VAR	VAR	4.5	VAR	2.25
9.529	12.887	12.887	12.890	12.890	VAR	VAR	6	VAR	3
11.911	16.109	16.109	16.113	16.112	VAR	VAR	8	VAR	3

COLORS: LEGEND, BORDER – BLACK  
BACKGROUND – WHITE (RETROREFLECTIVE)

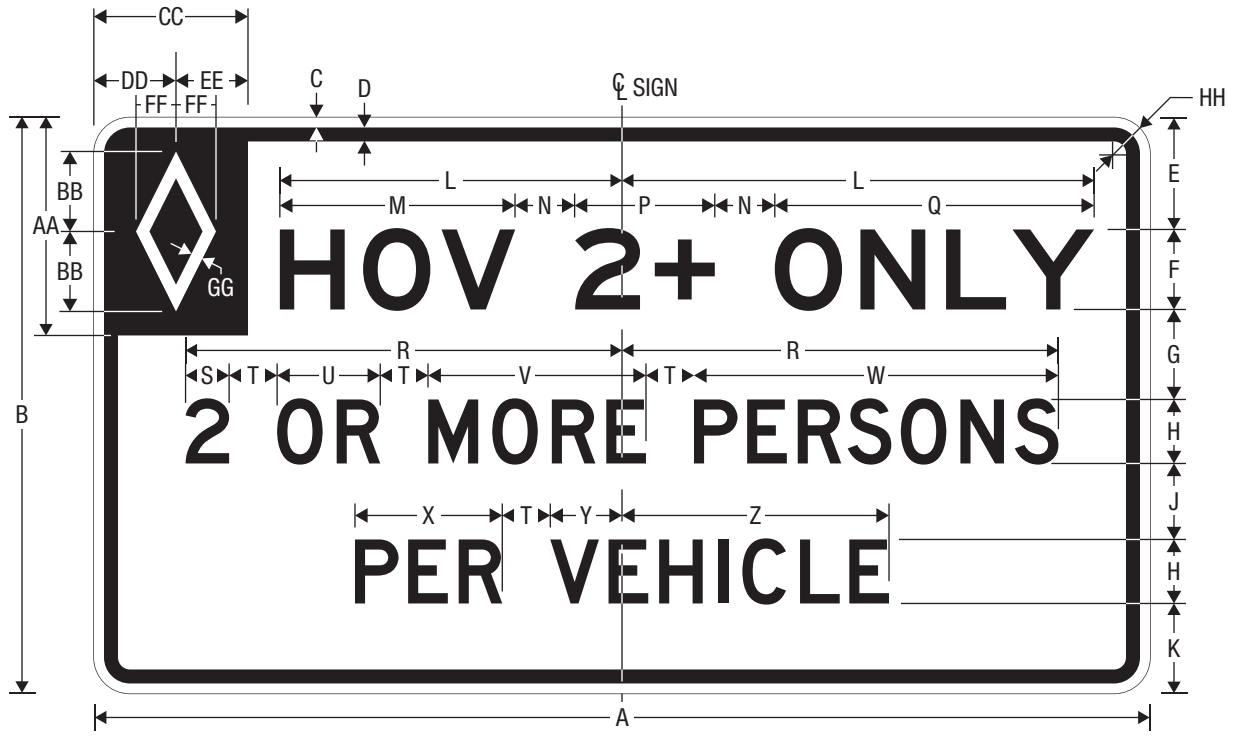

R3-13

PREFERENTIAL LANE VEHICLE OCCUPANCY DEFINITION (OVERHEAD)

A	B	C	D	E	F	G	H	J	K	L
66	36	0.625	0.875	7	5 E	5.625	4 D	4.75	5.625	VAR
84	48	0.75	1.25	9.25	6 E	9	5 D	5.75	8	VAR
144	78	1.125	1.875	13.5	10 E	13	9 D	11.5	12	VAR

M	N	P	Q	R	S	T	U	V	W	X
14.708	3.75	VAR	19.959	VAR	VAR	3	6.445	13.608	22.778	9.207
17.649	4.5	VAR	23.951	VAR	VAR	3.75	8.056	17.010	28.473	11.509
29.415	7.5	VAR	39.918	VAR	VAR	6.75	14.501	30.618	51.251	20.716

Y	Z	AA	BB	CC	DD	EE	FF	GG	HH
4.482	16.689	13.625	5	9.625	5.125	4.5	2.5	.75	2.25
5.603	20.861	18.75	7	12.5	6.608	5.892	3.5	1	3
10.085	37.550	27.875	11	21.5	11.5	10	5.5	1.75	4

COLORS: LEGEND – BLACK  
 BACKGROUND – WHITE (RETROREFLECTIVE)  
 SYMBOL – WHITE (RETROREFLECTIVE) ON BLACK

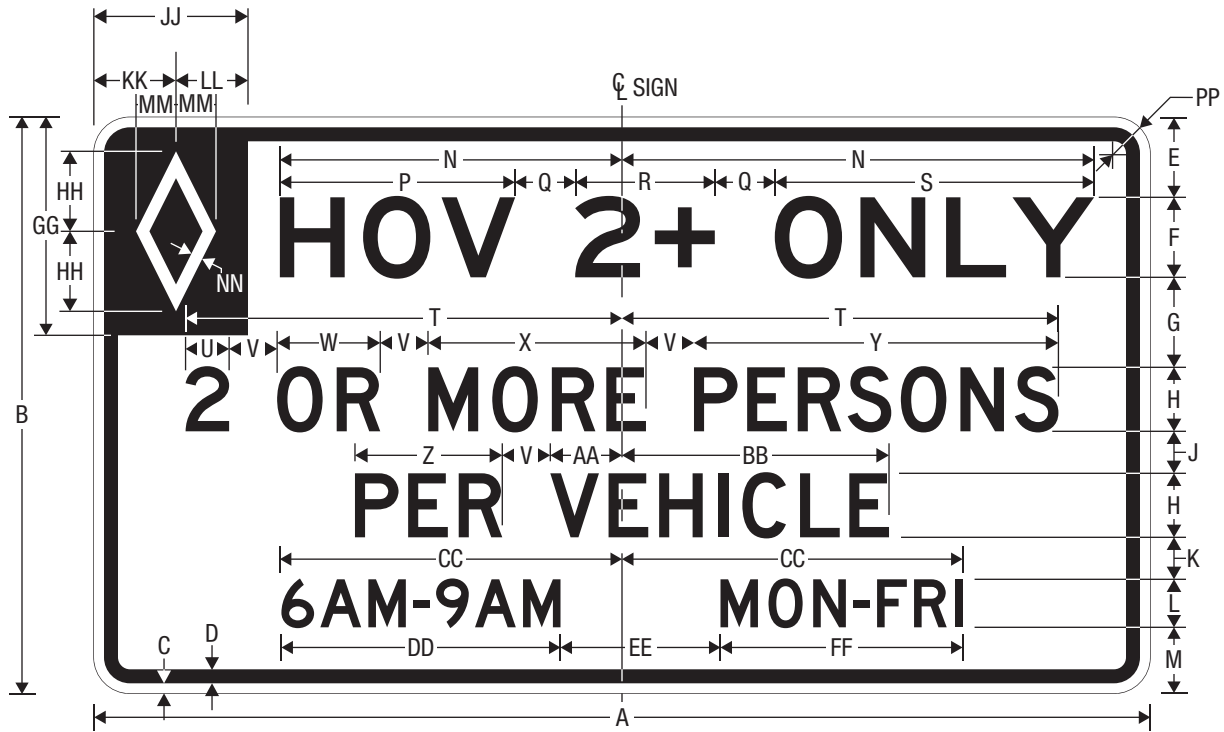

R3-13a

PREFERENTIAL LANE VEHICLE OCCUPANCY DEFINITION (OVERHEAD)

A	B	C	D	E	F	G	H	J	K	L	M	N
66	36	0.625	0.875	5	5 E	5.625	4 D	2.625	2.625	3 D	4.125	VAR
84	48	0.75	1.25	7.25	6 E	9	5 D	4	3.5	4 D	4.25	VAR
144	78	1.125	1.875	11.5	10 E	10	9 D	7	7	7 D	7.5	VAR

P	Q	R	S	T	U	V	W	X	Y	Z	AA	BB
14.708	3.75	VAR	19.959	VAR	VAR	3	6.445	13.608	22.778	9.207	4.482	16.689
17.649	4.5	VAR	23.951	VAR	VAR	3.75	8.056	17.010	28.473	11.509	5.603	20.861
29.415	7.5	VAR	39.918	VAR	VAR	6.75	14.501	30.618	51.251	20.716	10.085	37.550

CC	DD	EE	FF	GG	HH	JJ	KK	LL	MM	NN	PP
VAR	VAR	10	VAR	13.625	5	9.625	5.125	4.5	2.5	.75	2.25
VAR	VAR	12	VAR	18.75	7	12.5	6.608	5.892	3.5	1	3
VAR	VAR	21	VAR	27.875	11	21.5	11.5	10	5.5	1.75	4

COLORS: LEGEND – BLACK  
 BACKGROUND – WHITE (RETROREFLECTIVE)  
 SYMBOL – WHITE (RETROREFLECTIVE) ON BLACK

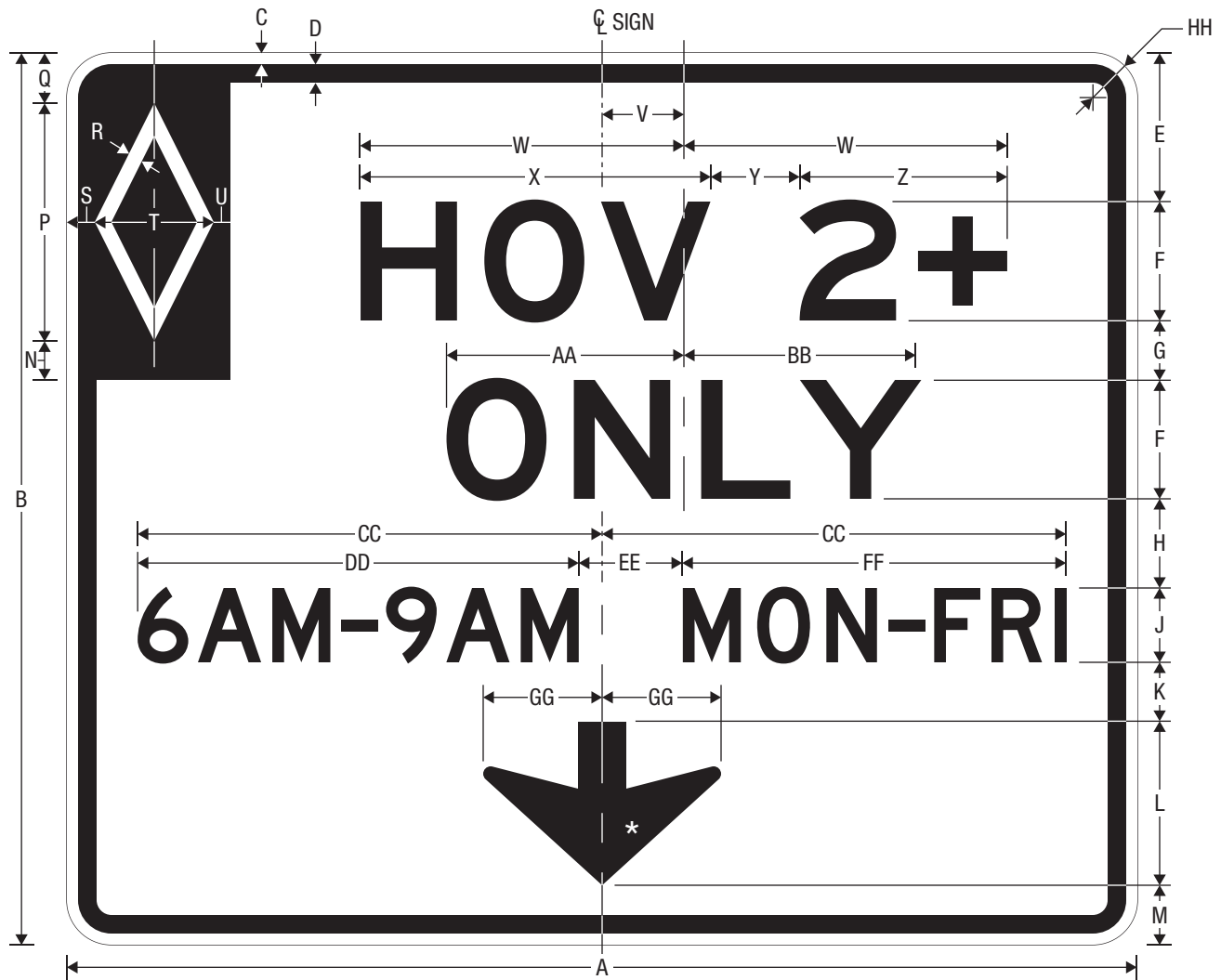

R3-14

HOV LANE OPERATION (OVERHEAD)

\* See page 7-5 for arrow design.

A	B	C	D	E	F	G	H	J	K	L
72	60	0.75	1.25	10	8 E	4	6	5 D	4	11
96	72	1.125	1.875	12	9 E	6	6	7 D	7	11
144	108	1.125	1.875	14	14 E	10	9.5	9 D	9.5	22

M	N	P	Q	R	S	T	U	V	W	X
4	2.625	16	3.375	1	1.875	8	1.125	5.5	VAR	23.532
5	4.5	20	5.625	1.5	3.063	10	1.938	5.5	VAR	26.474
6	5	30	6.125	2	4.063	15	2.938	5.5	VAR	41.181

Y	Z	AA	BB	CC	DD	EE	FF	GG	HH
6	VAR	15.967	15.967	VAR	VAR	7	VAR	8	3
6.75	VAR	17.963	17.963	VAR	VAR	8	VAR	8	6
12	VAR	27.943	27.942	VAR	VAR	16	VAR	16	9

UPPER LEFT SECTION

COLORS: LEGEND — WHITE (RETROREFLECTIVE)  
BACKGROUND — BLACK

REMAINDER OF SIGN

COLORS: LEGEND, BORDER — BLACK  
BACKGROUND — WHITE (RETROREFLECTIVE)

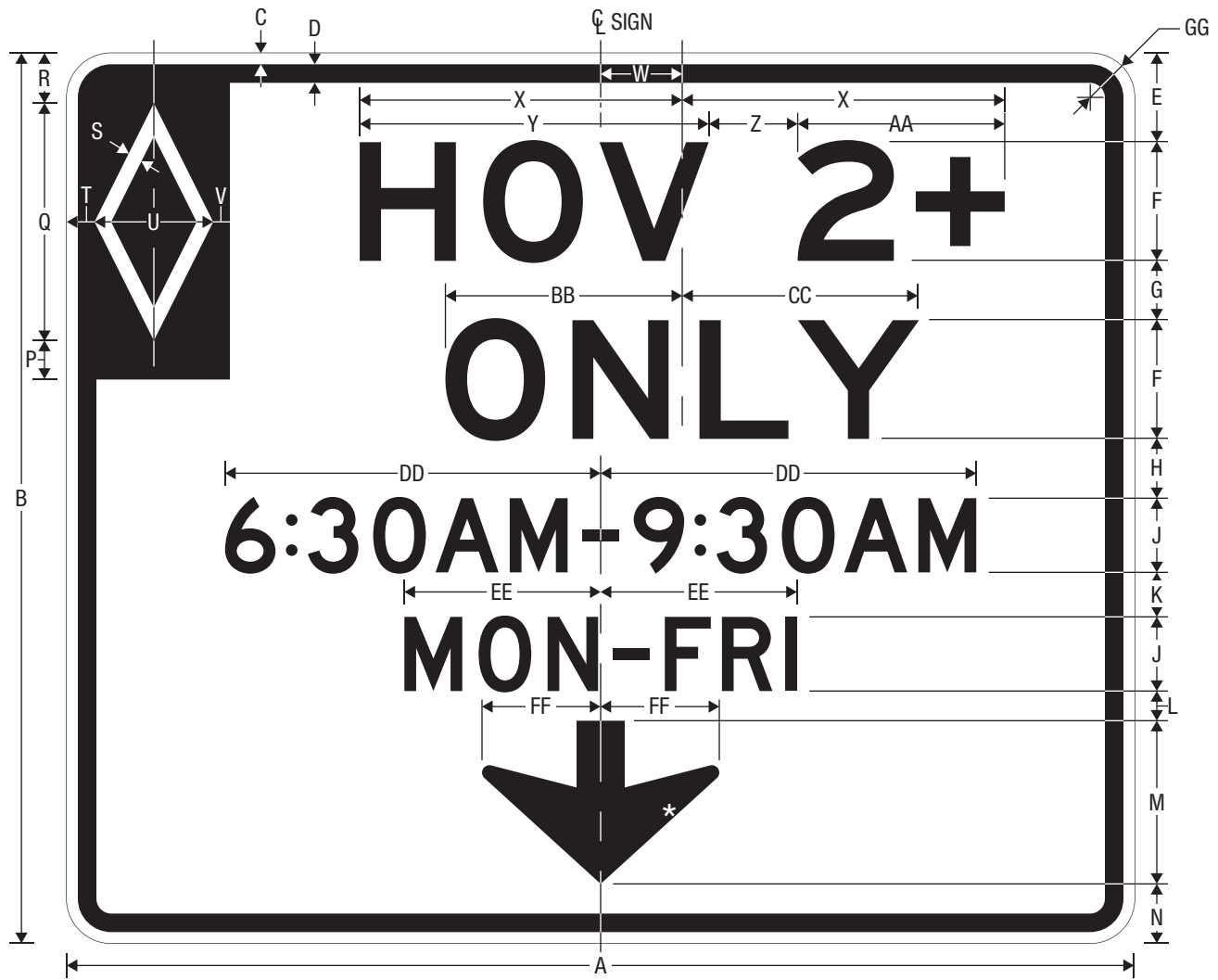

R3-14a

HOV LANE OPERATION (OVERHEAD)

\* See page 7-5 for arrow design.

A	B	C	D	E	F	G	H	J	K	L
72	60	0.75	1.25	6	8 E	4	4	5 D	3	2
96	72	0.75	1.25	7	9 E	5	5	7 D	4	3
144	108	0.75	1.25	9	14 E	8	7	9 D	6	4

M	N	P	Q	R	S	T	U	V	W
11	4	2.625	16	3.375	1	1.875	8	1.125	5.5
11	5	4.5	20	5.625	1.5	3.063	10	1.938	5.5
22	6	5	30	6.125	2	4.063	15	2.938	5.5

X	Y	Z	AA	BB	CC	DD	EE	FF	GG
VAR	23.532	6	VAR	15.967	15.967	VAR	VAR	8	3
VAR	26.474	6.75	VAR	17.963	17.963	VAR	VAR	8	6
VAR	41.181	12	VAR	27.943	27.942	VAR	VAR	16	9

UPPER LEFT SECTION

COLORS: LEGEND — WHITE (RETROREFLECTIVE)  
BACKGROUND — BLACK

REMAINDER OF SIGN

COLORS: LEGEND, BORDER — BLACK  
BACKGROUND — WHITE (RETROREFLECTIVE)



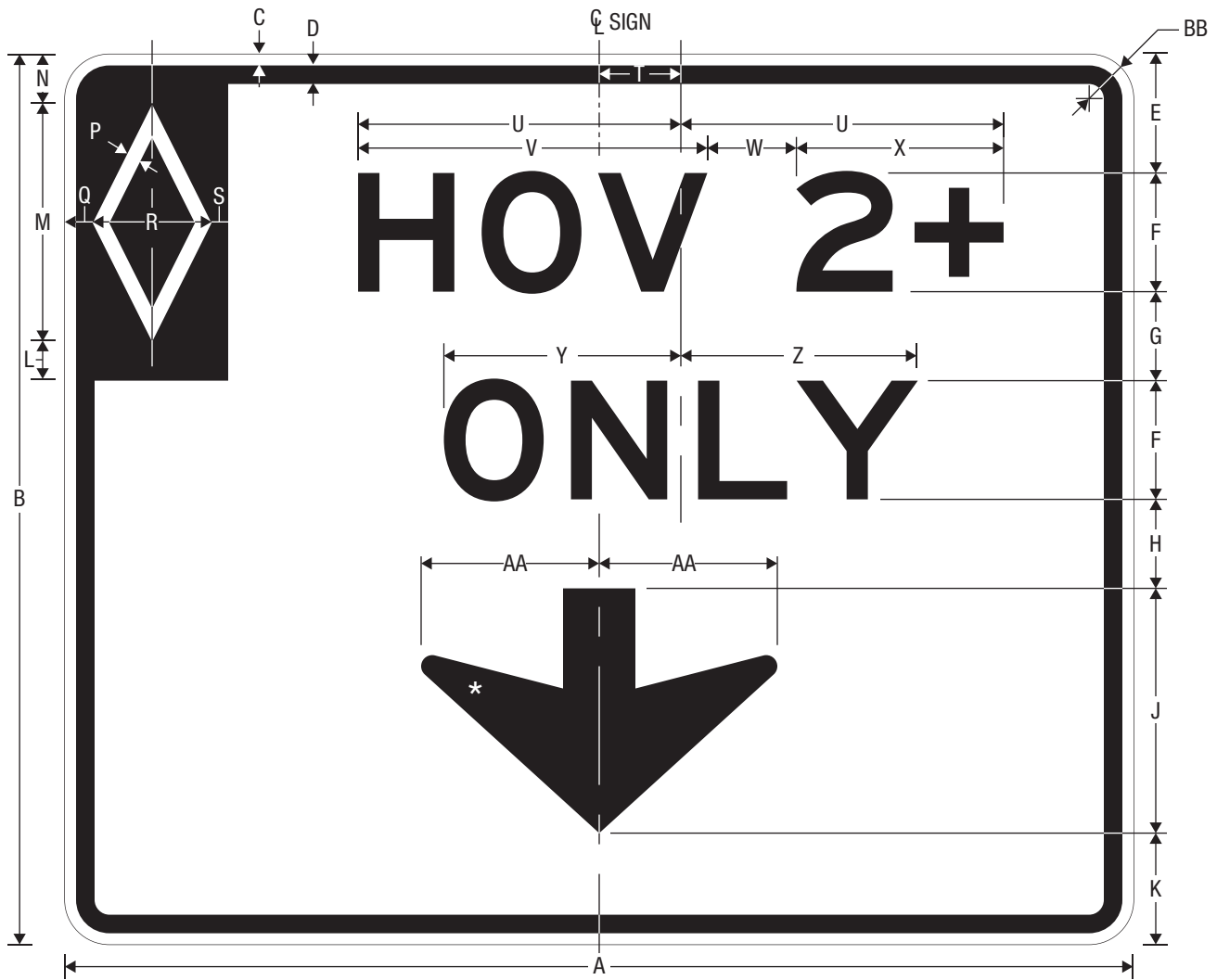

R3-14b  
HOV LANE OPERATION (OVERHEAD)

\* See page 7-5 for arrow design.

A	B	C	D	E	F	G	H	J	K	L	M	N
72	60	0.75	1.25	8	8 E	6	6	16.5	7.5	2.625	16	3.375
96	72	0.75	1.25	10	10 E	7	9	16.5	9.5	4.125	27	4.875
120	96	0.75	1.25	12	12 E	10	15	22	13	5.625	36	6.375

P	Q	R	S	T	U	V	W	X	Y	Z	AA	BB
1	1.875	8	1.125	5.5	VAR	23.532	6	VAR	15.967	15.967	12	3
1.875	4.25	13.5	3.25	10.5	VAR	29.415	8	VAR	19.959	19.959	12	6
2.5	6.375	18	5.625	15	VAR	35.298	12	VAR	23.951	23.950	16	9

UPPER LEFT SECTION  
 COLORS: LEGEND — WHITE (RETROREFLECTIVE)  
 BACKGROUND — BLACK

REMAINDER OF SIGN  
 COLORS: LEGEND, BORDER — BLACK  
 BACKGROUND — WHITE (RETROREFLECTIVE)

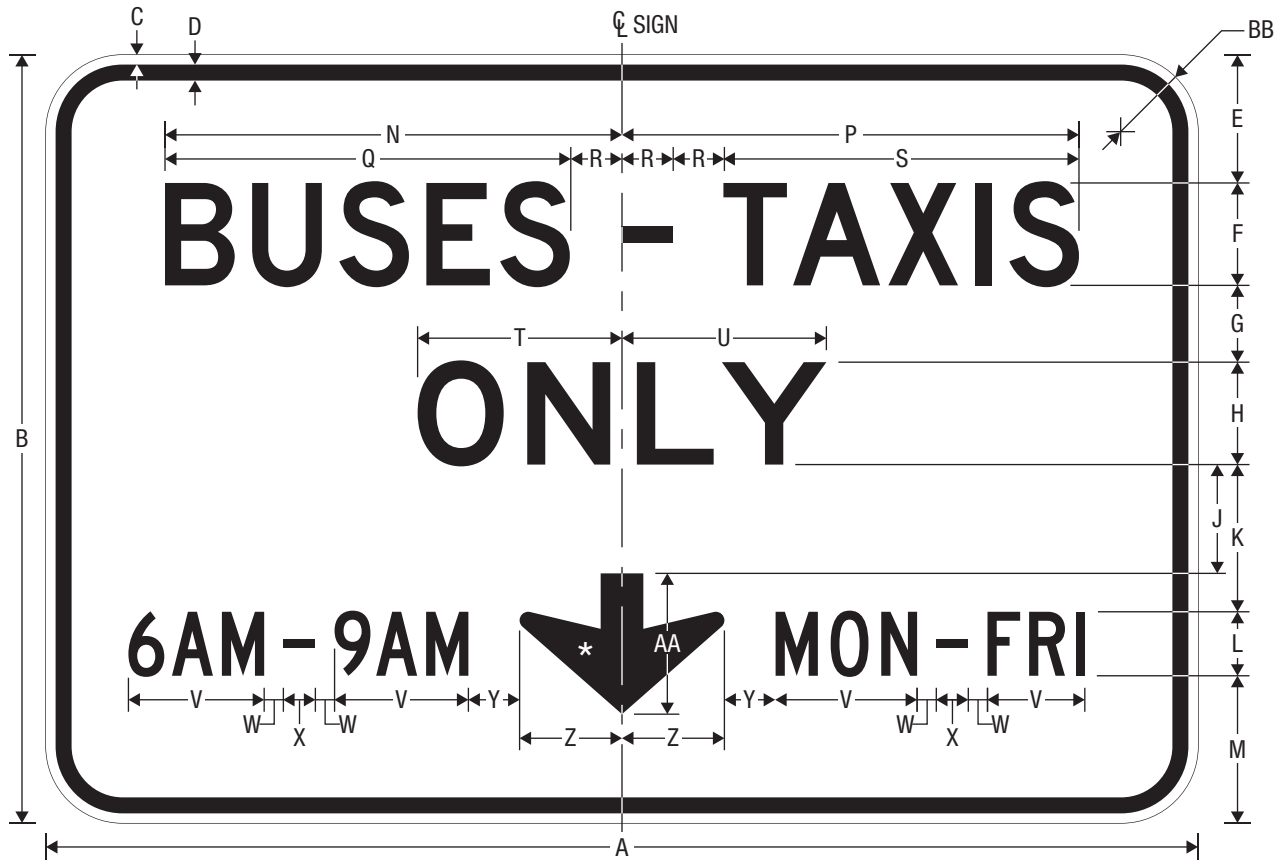

R3-14c

PREFERENTIAL LANE OPERATION (OVERHEAD)

\* See page 7-5 for arrow design.

A	B	C	D	E	F	G	H	J	K	L	M	N
90	60	0.75	1.25	10	8 D	6	8 E	8.5	11.5	5 C	11.5	35.702
108	72	0.75	1.25	10	10 D	7.5	10 E	10	15.25	6 C	13.25	44.628
156	102	0.75	1.25	16	12 E	10	12 E	17	23	8 D	21	62.723

P	Q	R	S	T	U	V	W	X	Y	Z	AA	BB
35.702	31.626	4	27.778	15.967	15.967	VAR	1.5	2.5	4	8	11	6
44.628	39.533	5	34.723	19.959	19.959	VAR	2	3	4.5	12	16.5	6
62.722	56.784	6	50.661	23.951	23.950	VAR	2.5	4	6	16	22	9

COLORS: LEGEND, BORDER – BLACK  
BACKGROUND – WHITE (RETROREFLECTIVE)

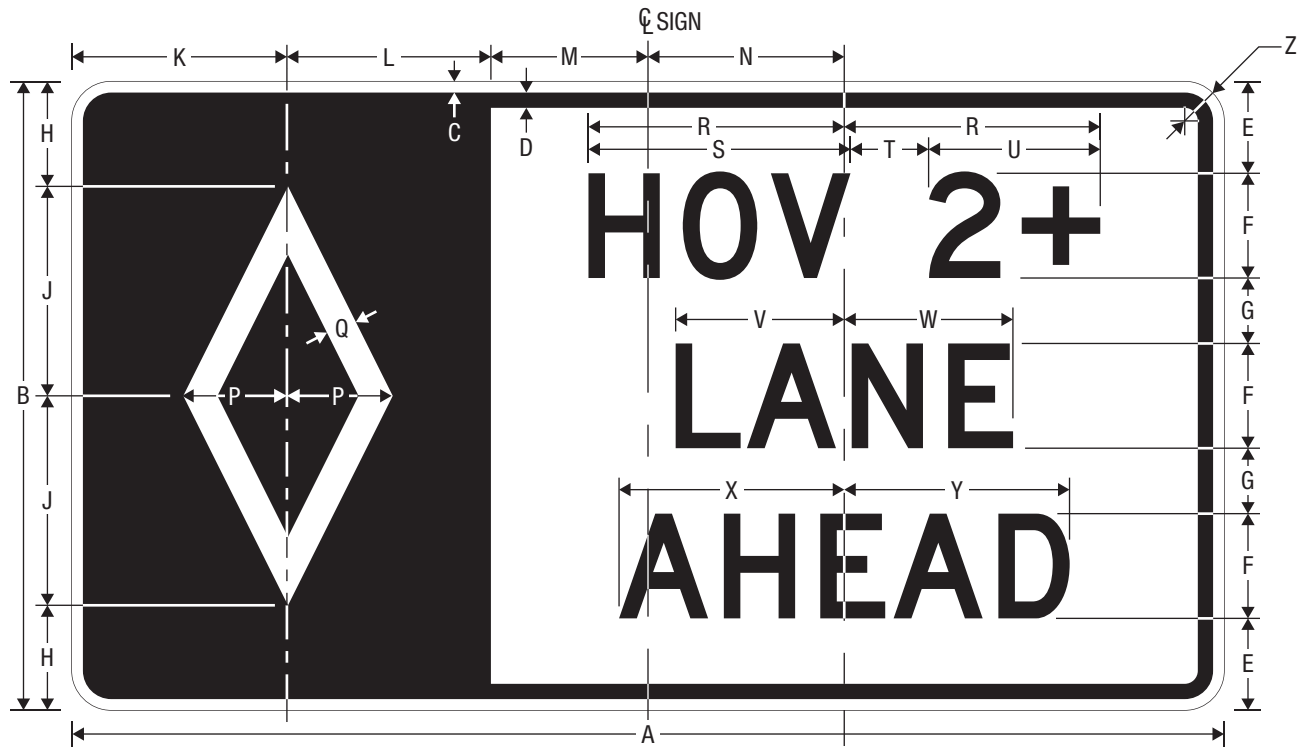

R3-15  
HOV LANE AHEAD (OVERHEAD)

A	B	C	D	E	F	G	H	J	K	L	M
66	36	0.625	0.875	5.25	6 D	3.75	6	12	12.313	11.687	9
84	48	0.75	1.25	7	8 D	5	8	16	15.375	14.625	12
102	60	0.75	1.25	8.625	10 D	6.375	10	20	18.375	17.625	15

N	P	Q	R	S	T	U	V	W	X	Y	Z
11.25	6	1.75	VAR	15.011	4.5	8.888	9.666	9.665	12.909	12.908	2.25
14	8	2.25	VAR	20.014	6	11.85	12.887	12.887	17.211	17.211	3
16.75	10	3	VAR	25.018	7.5	14.813	16.109	16.109	21.514	21.514	3

LEFT SECTION

COLORS: LEGEND — WHITE (RETROREFLECTIVE)  
BACKGROUND — BLACK

RIGHT SECTION

COLORS: LEGEND, BORDER — BLACK  
BACKGROUND — WHITE (RETROREFLECTIVE)

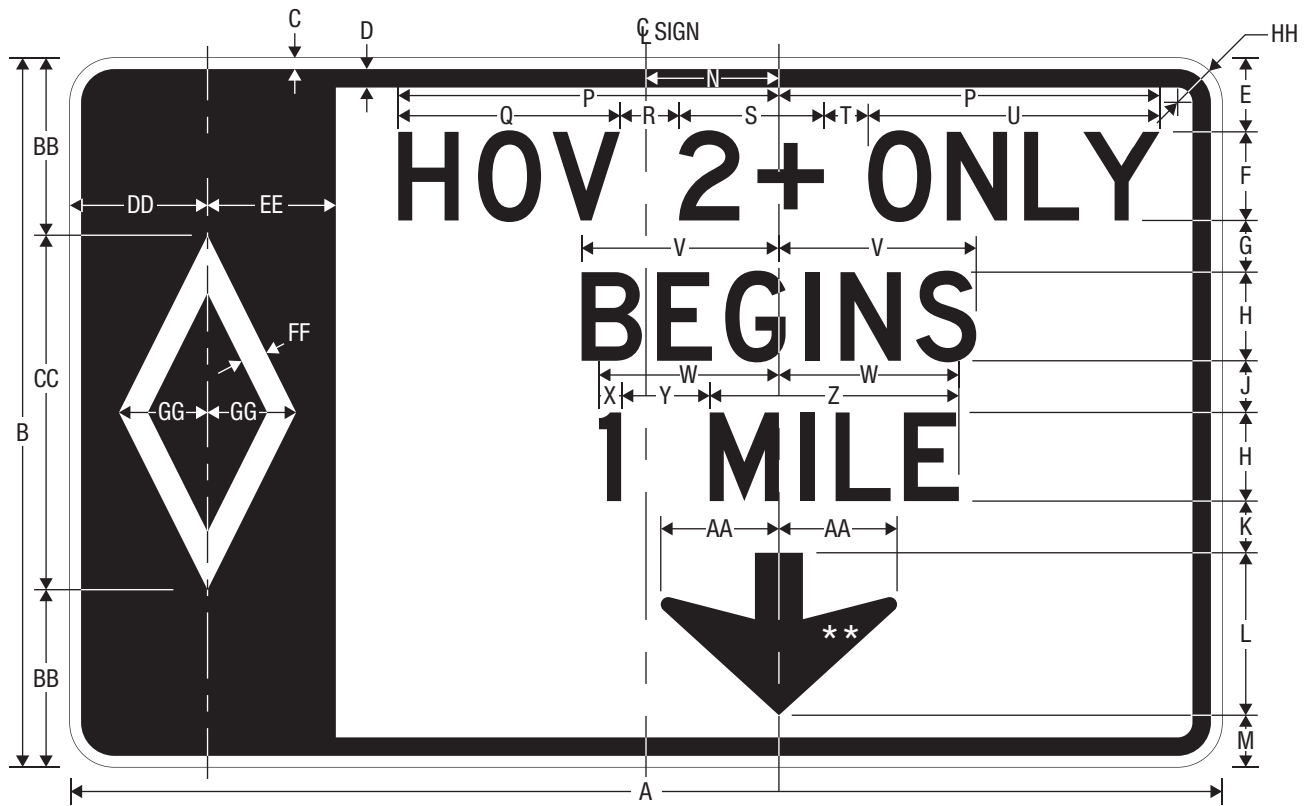

R3-15a

HOV LANE BEGINS XX MILES (OVERHEAD)

\* Reduce Spacing 20%.

\*\* See page 7-5 for arrow design.

A	B	C	D	E	F	G	H	J	K	L
78	48	0.75	1.25	5	6 D	3.5	6 D	3.5	3.5	16
114	72	0.75	1.25	8	8 D	6	8 E	6	5.5	16.5
144	84	0.75	1.25	8	10 D	8	10 E	8	7.5	16.5
150	108	0.75	1.25	12	12 D	10	12 E	10.5	9.5	22

M	N	P	Q	R	S	T	U	V	W	X
3.5	9	VAR	15.011	4	VAR	3	19.728*	13.360	VAR	VAR
6	15	VAR	20.014	6	VAR	6	26.304*	20.928	VAR	VAR
6	18	VAR	25.018	8	VAR	8	32.880*	26.160	VAR	VAR
8	18.133	VAR	30.021	9	VAR	8	39.456*	31.392	VAR	VAR

Y	Z	AA	BB	CC	DD	EE	FF	GG	HH
6	VAR	8	12	24	9.313	8.687	1.75	6	3
10	VAR	12	20	32	15.375	14.625	2.25	8	9
12	VAR	12	22	40	18.375	17.625	2.75	10	9
15	VAR	16	32	44	18.375	17.625	3.5	11	12

LEFT SECTION

COLORS: LEGEND — WHITE (RETROREFLECTIVE)  
BACKGROUND — BLACK

RIGHT SECTION

COLORS: LEGEND, BORDER — BLACK  
BACKGROUND — WHITE (RETROREFLECTIVE)

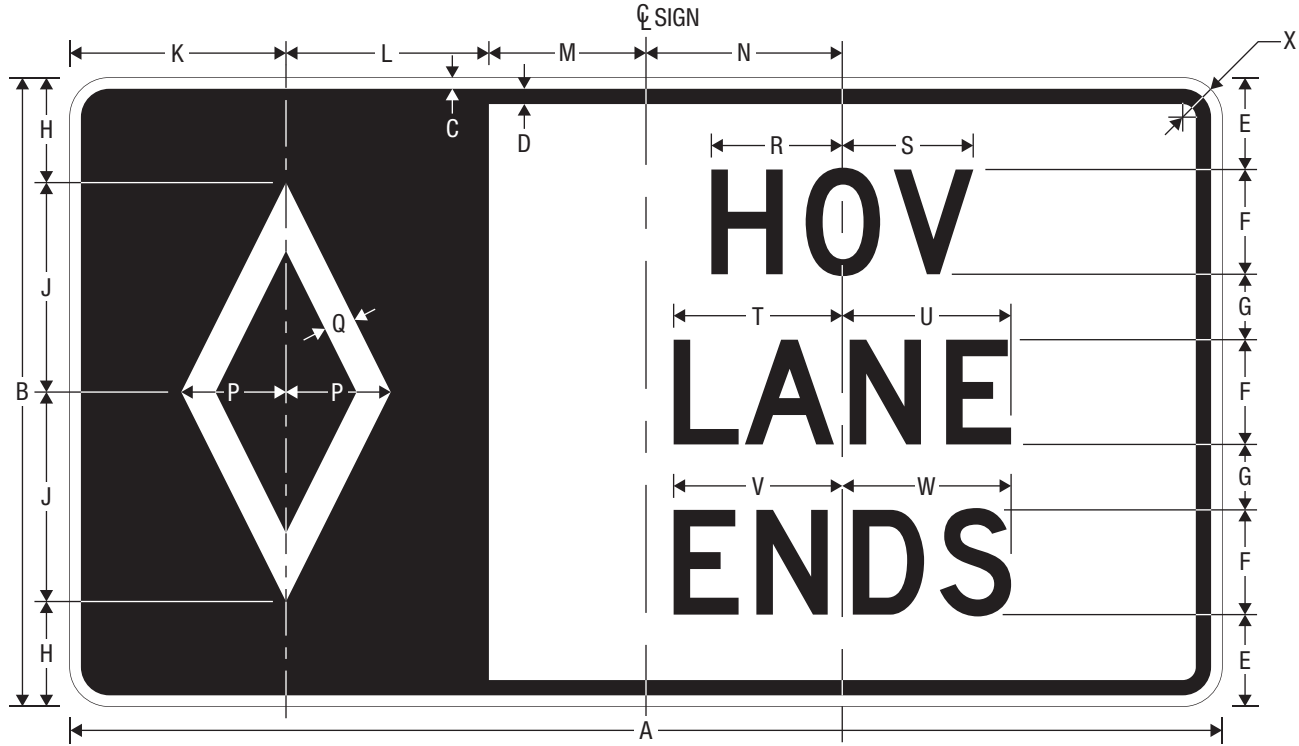

R3-15b  
HOV LANE ENDS (OVERHEAD)

A	B	C	D	E	F	G	H	J	K	L
66	36	0.625	0.875	5.25	6 D	3.75	6	12	12.375	11.625
84	48	0.75	1.25	7	8 D	5	8	16	15.375	14.625
102	60	0.75	1.25	8.625	10 D	6.375	10	20	18.375	17.625

M	N	P	Q	R	S	T	U	V	W	X
9	11.25	6	1.75	7.506	7.505	9.666	9.665	9.668	9.667	2.25
12	14	8	2.25	10.007	10.007	12.887	12.887	12.890	12.890	3
15	16.75	10	3	12.509	12.509	16.109	16.109	16.113	16.112	3

LEFT SECTION

COLORS: LEGEND — WHITE (RETROREFLECTIVE)  
BACKGROUND — BLACK

RIGHT SECTION

COLORS: LEGEND, BORDER — BLACK  
BACKGROUND — WHITE (RETROREFLECTIVE)

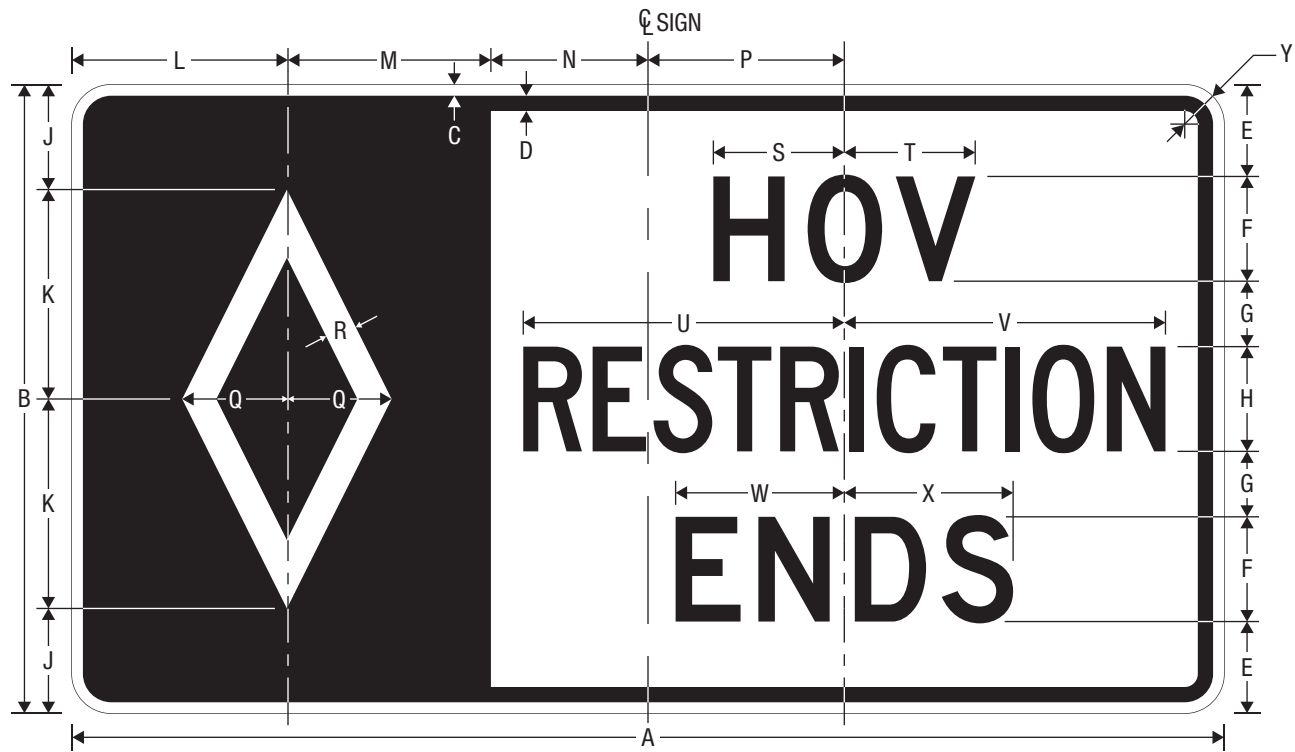

R3-15c  
HOV LANE ENDS (OVERHEAD)

\* Reduce Spacing 40%.  
\*\* Reduce Spacing 50%.

A	B	C	D	E	F	G	H	J	K	L	M
66	36	0.625	0.875	5.25	6 D	3.75	6 C*	6	12	12.313	11.687
84	48	0.75	1.25	7	8 D	5	8 C**	8	16	15.375	14.625
102	60	0.75	1.25	8.625	10 D	6.375	10 C**	10	20	18.375	17.625

N	P	Q	R	S	T	U	V	W	X	Y
9	11.25	6	1.75	7.506	7.505	18.397	18.397	9.668	9.667	2.25
12	14	8	2.25	10.007	10.007	23.909	23.909	12.890	12.890	3
14.875	17.063	10	3	12.509	12.509	29.887	29.886	16.113	16.112	3

LEFT SECTION

COLORS: LEGEND — WHITE (RETROREFLECTIVE)  
BACKGROUND — BLACK

RIGHT SECTION

COLORS: LEGEND, BORDER — BLACK  
BACKGROUND — WHITE (RETROREFLECTIVE)

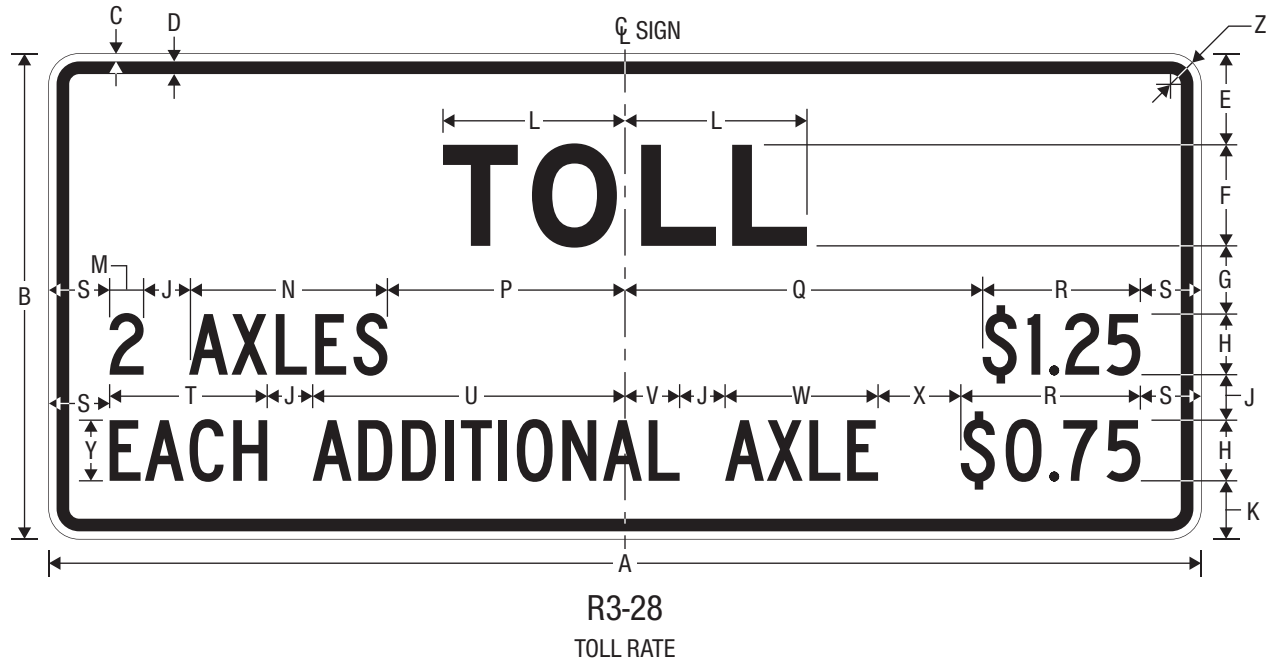

\* Reduce Spacing 20%.

A	B	C	D	E	F	G	H	J	K	L	M
114	48	0.75	1.25	9	10 E(m)	6.75	6 C	4.5	5.75	18.010	3.362

N	P	Q	R	S	T	U	V	W	X	Y	Z
19.628	23.511	VAR	VAR	6	15.594	30.906	5.406	15.138	6 MIN	6 C*	3

COLORS: LEGEND, BORDER – BLACK  
BACKGROUND – WHITE (RETROREFLECTIVE)

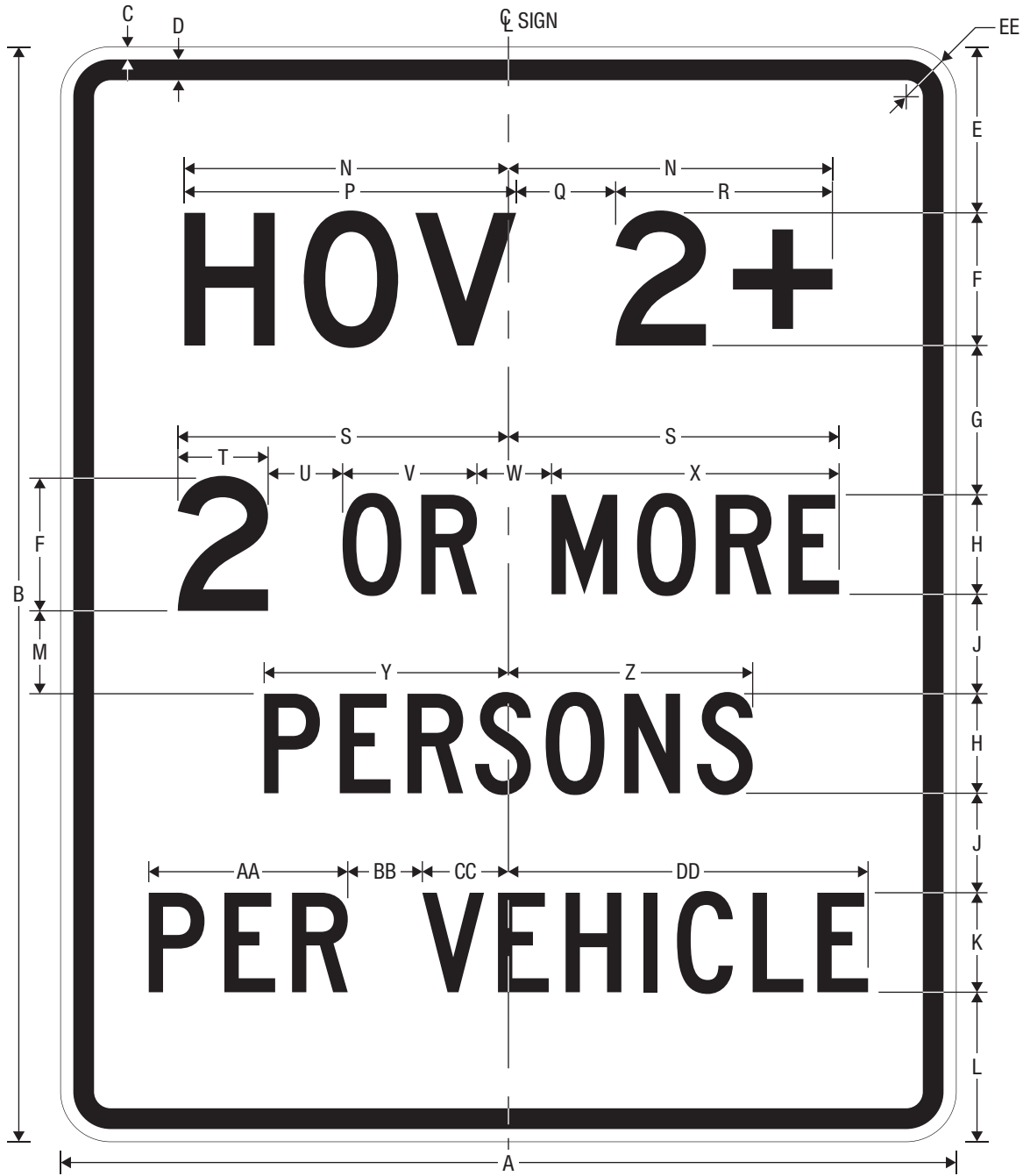

R3-40

PRICED MANAGED LANE VEHICLE OCCUPANCY DEFINITION (POST-MOUNTED)

\* Reduce Spacing 20%.

A	B	C	D	E	F	G	H	J	K	L	M	N	P	Q
54	66	0.75	1.25	10	8 D	9	6 C	6	6 C	9	5	VAR	20.014	6
66	78	0.75	1.25	10	10 D	11	8 C	7.5	8 C*	8	6.5	VAR	25.018	7.5

R	S	T	U	V	W	X	Y	Z	AA	BB	CC	DD	EE
VAR	VAR	VAR	4.5	8.103	4.5	17.348	14.736	14.735	12.005	4.5	5.192	21.697	3
VAR	VAR	VAR	5.5	10.804	6	23.130	19.647	19.647	15.414	4	7.363	26.777	3

COLORS: LEGEND, BORDER – BLACK  
BACKGROUND – WHITE (RETROREFLECTIVE)



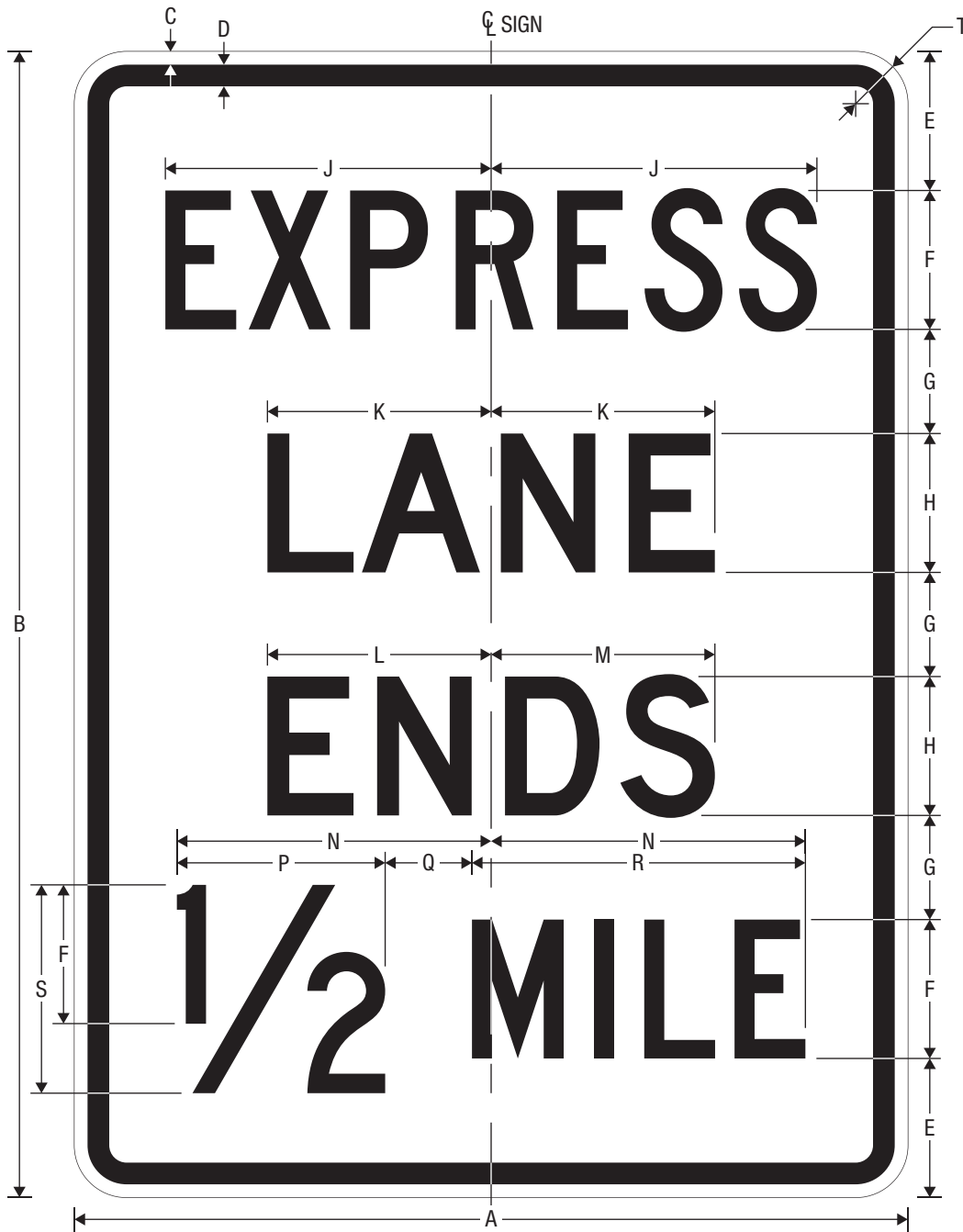

R3-42a

PRICED MANAGED LANE ENDS ADVANCE (POST-MOUNTED)

A	B	C	D	E	F	G	H	J
48	66	0.75	1.25	8	8 C	6	8 D	18.767
60	84	0.75	1.25	10	10 C	8	10 D	23.459

K	L	M	N	P	Q	R	S	T
12.887	12.890	12.890	VAR	VAR	5	VAR	12	3
16.109	16.113	16.112	VAR	VAR	6.25	VAR	15	3

COLORS: LEGEND, BORDER – BLACK  
BACKGROUND – WHITE (RETROREFLECTIVE)

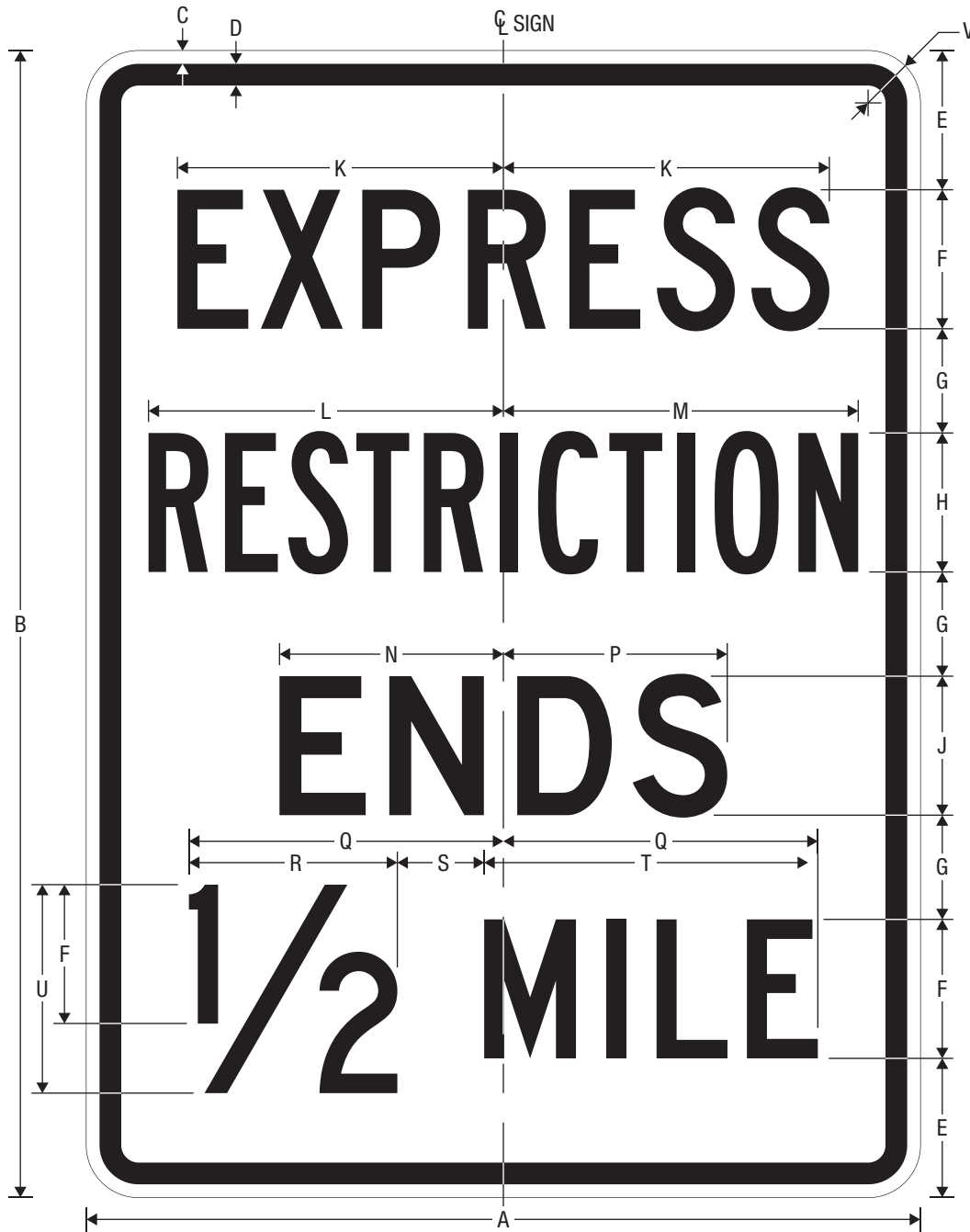

R3-42c

PRICED MANAGED LANE RESTRICTION ENDS ADVANCE (POST-MOUNTED)

\* Reduce Spacing 25%.

A	B	C	D	E	F	G	H	J	K
48	66	0.75	1.25	8	8 C	6	8 B*	8 D	18.767
60	84	0.75	1.25	10	10 C	8	10 B*	10 D	23.459

L	M	N	P	Q	R	S	T	U	V
20.429	20.429	12.890	12.890	VAR	VAR	5	19.208	12	3
25.537	25.536	16.113	16.112	VAR	VAR	6.25	24.010	15	3

COLORS: LEGEND, BORDER – BLACK  
BACKGROUND – WHITE (RETROREFLECTIVE)

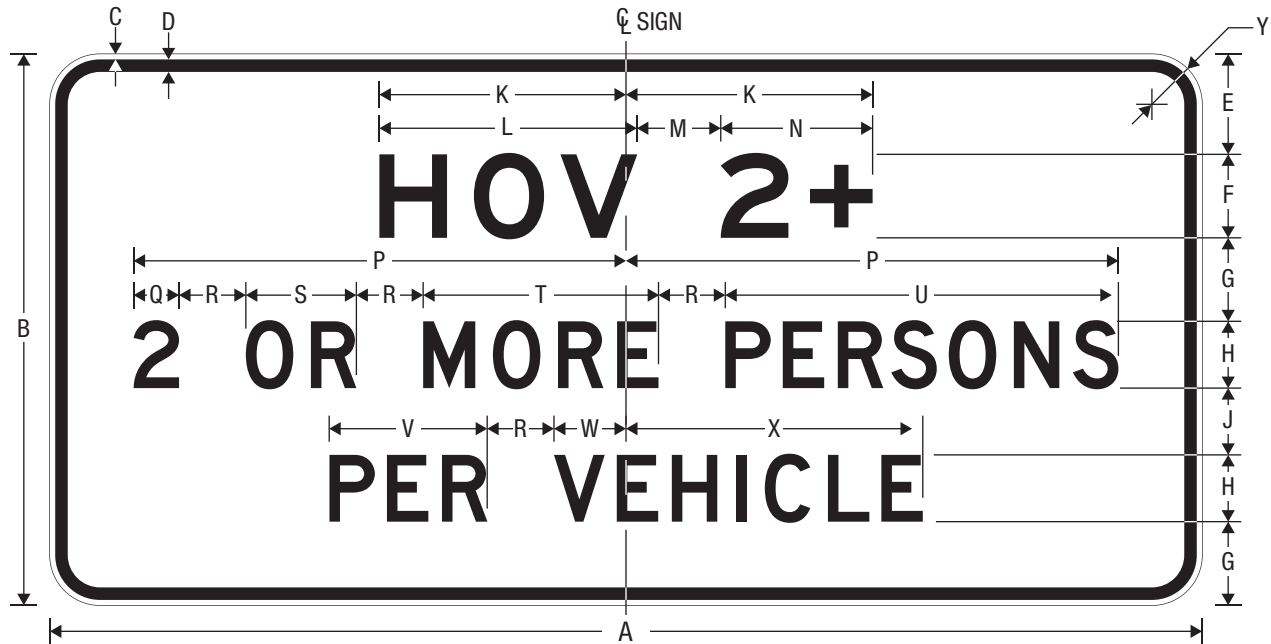

R3-43

PRICED MANAGED LANE VEHICLE OCCUPANCY DEFINITION

\* Increase Spacing 40%.

\*\* Increase Spacing 20%.

A	B	C	D	E	F	G	H	J	K	L	M
138	66	0.625	1.5	12	10 E*	10	8 D**	8	VAR	30.895	10

N	P	Q	R	S	T	U	V	W	X	Y
VAR	VAR	VAR	8	13.242	28.192	47.092	18.926	8.628	35.554	6

COLORS: LEGEND, BORDER – BLACK  
BACKGROUND – WHITE (RETROREFLECTIVE)



R3-44

PRICED MANAGED LANE OPERATION (OVERHEAD)

\* Pictograph shown is an example.

\*\* See page 7-5 for arrow design.

A	B	C	D	E	F	G	H
90	84	0.75	1.5	10	24 MIN	8	10 E

J	K	L	M	N	P
16.5	7.5	VAR	19.959	12	9

COLORS: LEGEND, BORDER – BLACK  
 PICTOGRAPH – VARIES (RETROREFLECTIVE)  
 BACKGROUND – WHITE (RETROREFLECTIVE)

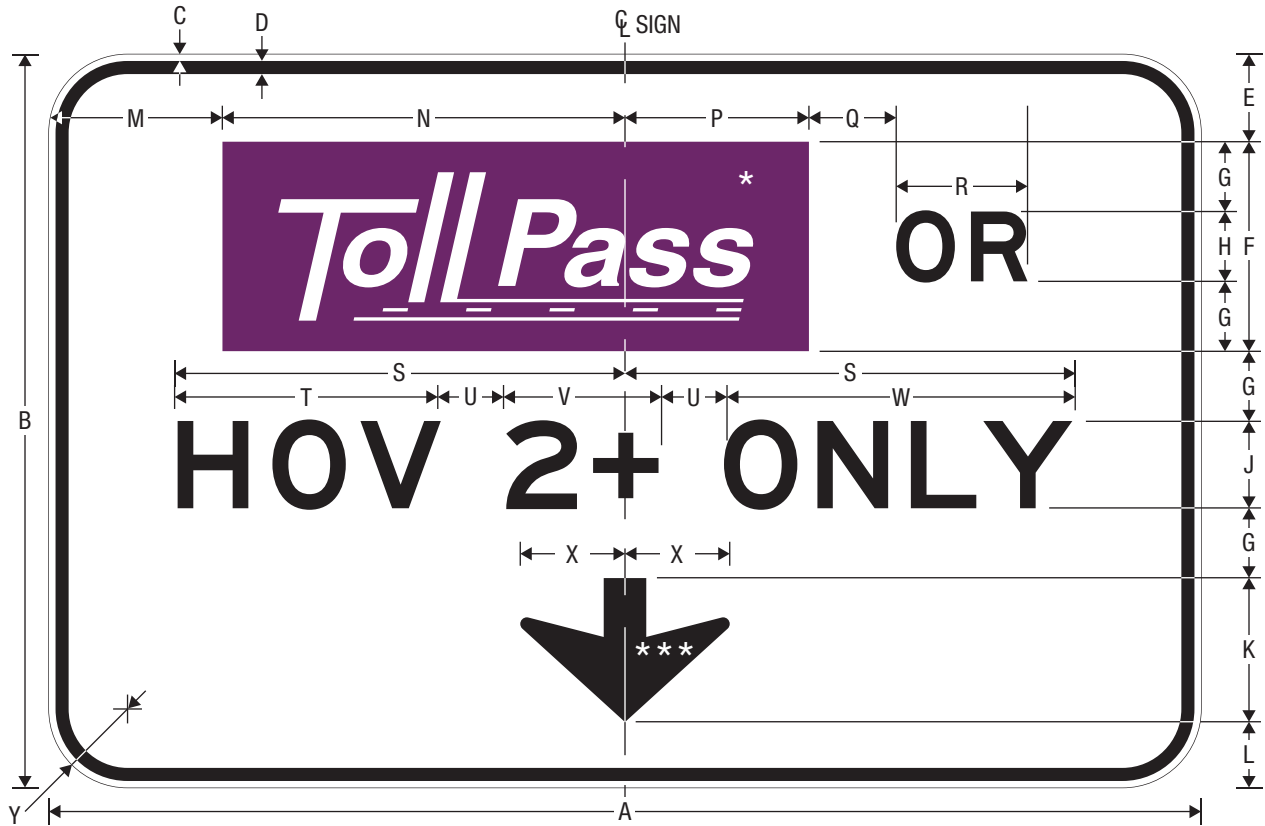

R3-44a

PRICED MANAGED LANE OPERATION (OVERHEAD)

\* Pictograph shown is an example.

\*\* Increase Spacing 20%.

\*\*\* See page 7-5 for arrow design.

A	B	C	D	E	F	G	H	J	K	L	M
132	84	0.75	1.5	10	24 MIN	8	8 E	10 E	16.5	7.5	12 MIN

N	P	Q	R	S	T	U	V	W	X	Y
VAR	VAR	10	15.048	VAR	30.155**	7.5	VAR	39.918	12	9

COLORS: LEGEND, BORDER – BLACK  
 PICTOGRAPH – VARIES (RETROREFLECTIVE)  
 BACKGROUND – WHITE (RETROREFLECTIVE)



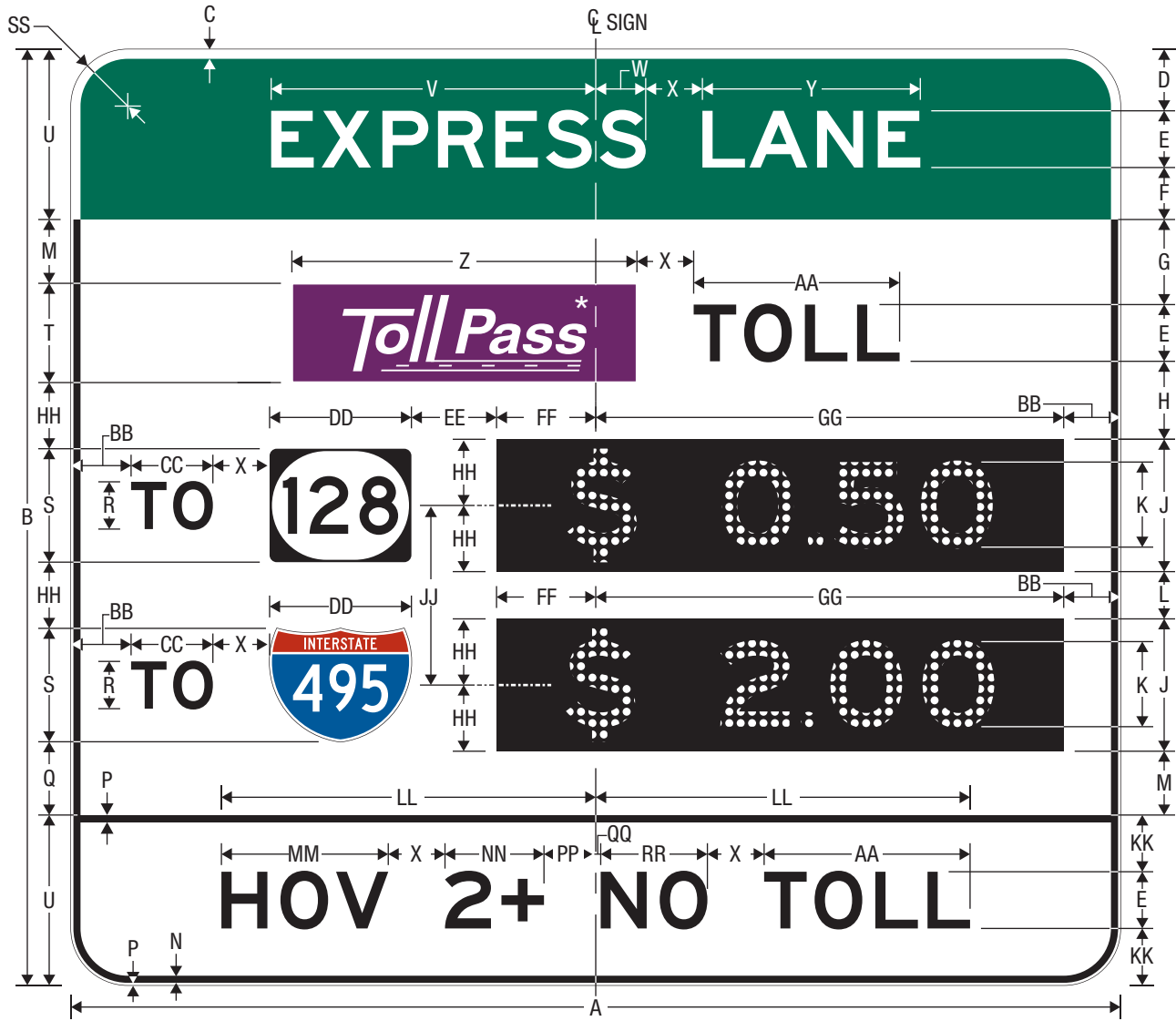

R3-48a

PRICED MANAGED LANE TOLL RATE

\* Pictograph shown is an example.

\*\* Changeable legend display. Dimensions may vary.

A	B	C	D	E	F	G	H	J	K	L	M	N	P
VAR	VAR	2	13	12 E	11	18	16.5	28	18 E	10	13.5	1.5	0.5
Q	R	S	T	U	V	W	X	Y	Z	AA	BB	CC	DD
15.5	10 E	24	21 MIN	36	68.663	10.567	12	46.095	VAR	43.566	12 MIN	17.305	VAR
EE	FF	GG	HH	JJ	KK	LL	MM	NN	PP	QQ	RR	SS	
18	21**	99**	14	38	12	VAR	35.298	VAR	10.655	1.345	22.572	12	

UPPER SECTION

COLORS: LEGEND, BORDER – WHITE (RETROREFLECTIVE)  
BACKGROUND – GREEN (RETROREFLECTIVE)

LOWER SECTION

COLORS: LEGEND, BORDER – BLACK  
BACKGROUND – WHITE (RETROREFLECTIVE)  
PICTOGRAPH – VARIES (RETROREFLECTIVE)

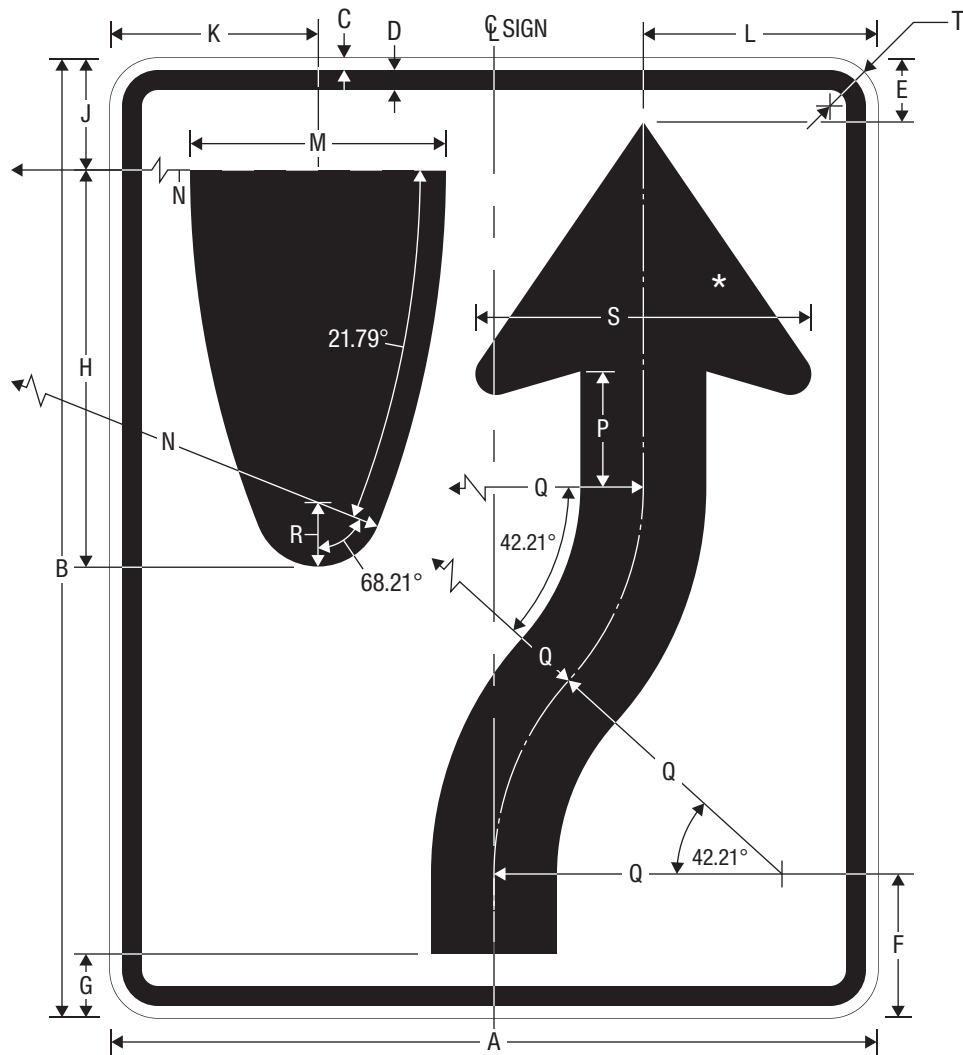

R4-7  
KEEP RIGHT

\* See page 7-3 for arrow design.

A	B	C	D	E	F	G	H	J
12	18	0.375	0.375	2.5	3.75	2.5	6.196	3.25
18	24	0.375	0.625	2.25	4.125	2.25	9.294	3.375
24	30	0.375	0.625	2	4.5	2	12.392	3.5
36	48	0.625	0.875	4.5	8.25	4.5	18.588	6.75
48	60	0.75	1.25	4	9	4	24.785	7

K	L	M	N	P	Q	R	S	T
3.25	3.667	4	15	1.807	4.5	1	5.25	1.5
4.875	5.5	6	22.5	2.711	6.75	1.5	7.875	1.5
6.5	7.333	8	30	3.615	9	2	10.5	1.5
9.75	11	12	45	5.422	13.5	3	15.75	2.25
13	14.667	16	60	7.230	18	4	21	3

COLORS: SYMBOL, BORDER — BLACK  
BACKGROUND — WHITE (RETROREFLECTIVE)





R4-7a  
KEEP RIGHT

\* See page 7-3 for arrow design.

A	B	C	D	E	F	G	H	J	K	L	M	N	P	Q
18	24	0.375	0.625	3.75	4 D	1.25	6	6.264	6.263	6	6	7.165	7.165	1.5
24	30	0.375	0.625	4.687	5 D	1.563	7.5	7.830	7.829	7.5	7.5	8.957	8.956	1.5
36	48	0.625	0.875	7.5	8 D	2.5	12	12.527	12.527	12	12	14.330	14.330	2.25
48	60	0.75	1.25	9.375	10 D	3.125	15	15.659	15.659	15	15	17.913	17.912	3

COLORS: LEGEND, BORDER — BLACK  
BACKGROUND — WHITE (RETROREFLECTIVE)

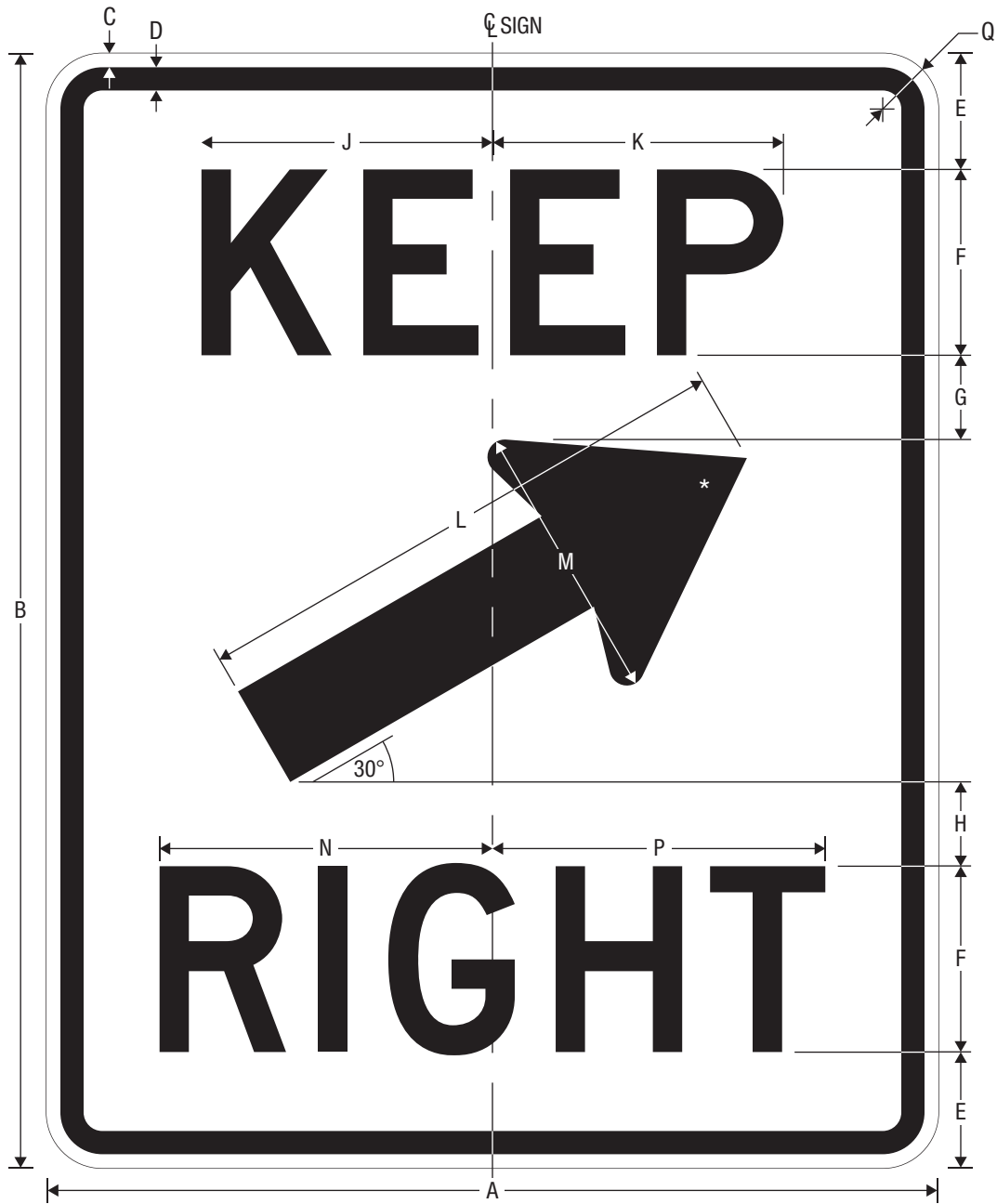

R4-7b  
KEEP RIGHT

\* See page 7-3 for arrow design.

A	B	C	D	E	F	G	H	J	K	L	M	N	P	Q
18	24	0.375	0.625	2.5	4 D	1.814	1.814	6.264	6.263	12	6	7.165	7.165	1.5
24	30	0.375	0.625	3.125	5 D	2.268	2.268	7.830	7.829	15	7.5	8.957	8.956	1.5
36	48	0.625	0.875	5	8 D	3.629	3.628	12.527	12.527	24	12	14.330	14.330	2.25
48	60	0.75	1.25	6.25	10 D	4.536	4.536	15.659	15.659	30	15	17.913	17.913	3

COLORS: LEGEND, BORDER — BLACK  
BACKGROUND — WHITE (RETROREFLECTIVE)

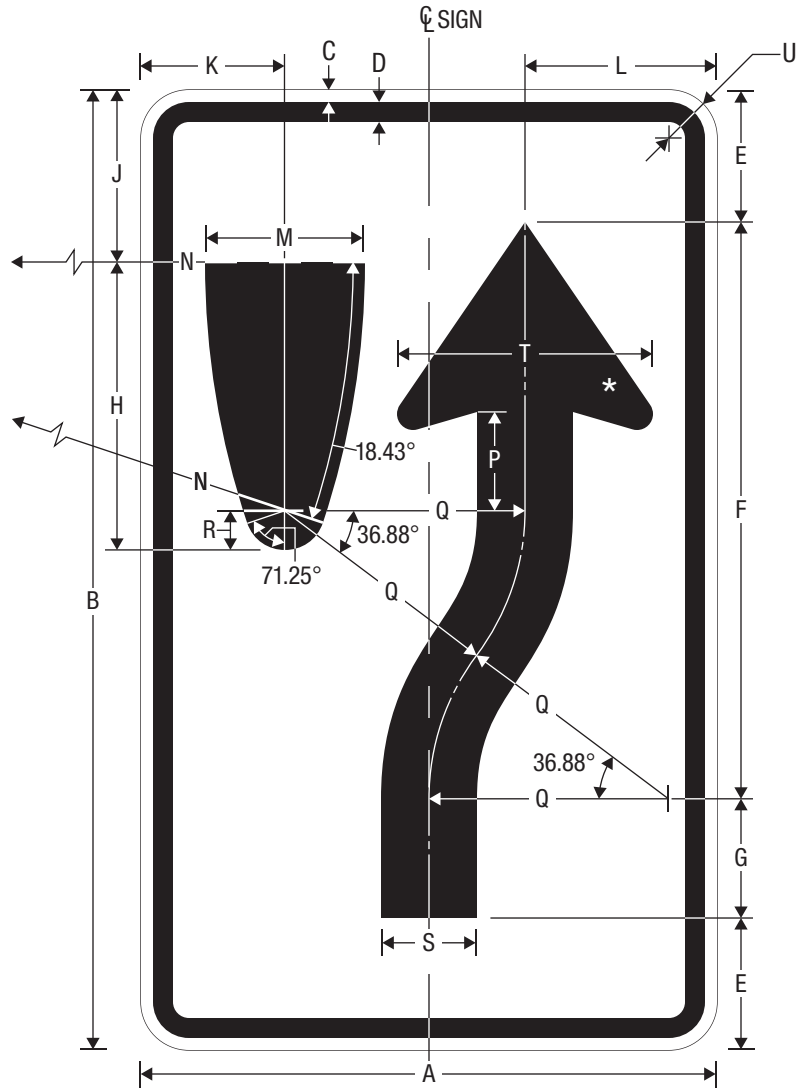

R4-7c  
NARROW KEEP RIGHT

\* See page 7-3 for arrow design.

A	B	C	D	E	F	G	H	J	K
18	30	0.375	0.625	4.125	18	3.75	9	5.375	4.5

L	M	N	P	Q	R	S	T	U
6	5	25.75	3.087	7.5	1.25	3	8	1.5

COLORS: LEGEND, BORDER — BLACK  
BACKGROUND — WHITE (RETROREFLECTIVE)

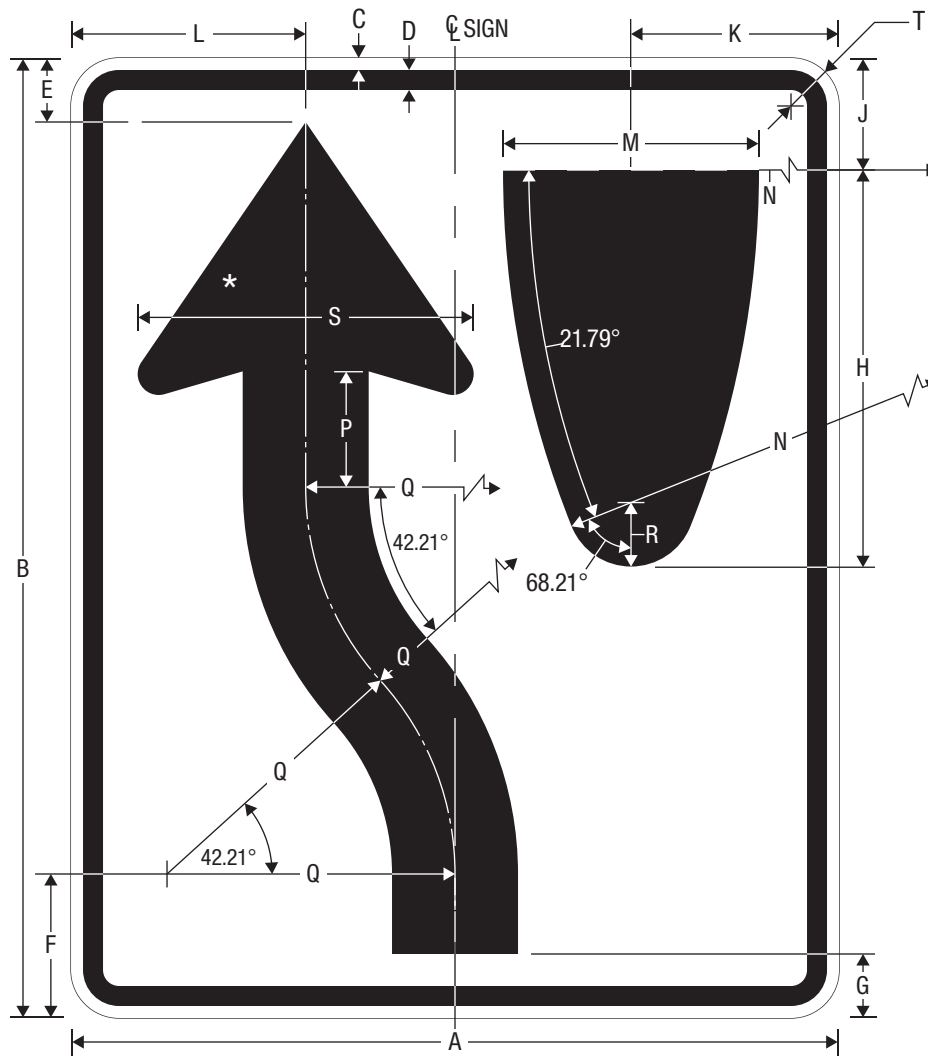

R4-8  
KEEP LEFT

\* See page 7-3 for arrow design.

A	B	C	D	E	F	G	H	J
18	24	0.375	0.625	2.25	4.125	2.25	9.294	3.375
24	30	0.375	0.625	2	4.5	2	12.392	3.5
36	48	0.625	0.875	4.5	8.25	4.5	18.588	6.75
48	60	0.75	1.25	4	9	4	24.785	7

K	L	M	N	P	Q	R	S	T
4.875	5.5	6	22.5	2.711	6.75	1.5	7.875	1.5
6.5	7.333	8	30	3.615	9	2	10.5	1.5
9.75	11	12	45	5.422	13.5	3	15.75	2.25
13	14.667	16	60	7.230	18	4	21	3

COLORS: SYMBOL, BORDER — BLACK  
BACKGROUND — WHITE (RETROREFLECTIVE)

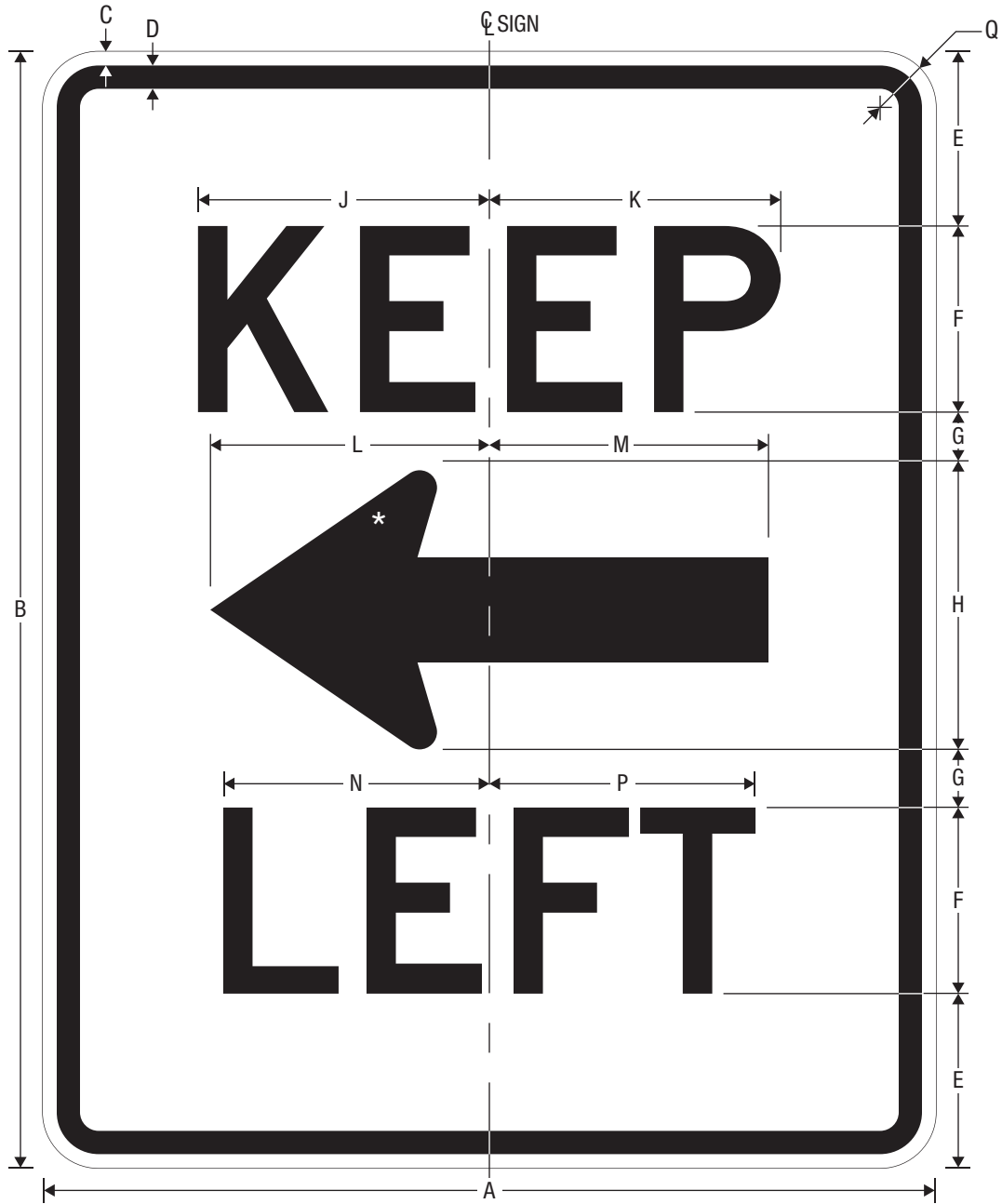

R4-8a  
KEEP LEFT

\* See page 7-3 for arrow design.

A	B	C	D	E	F	G	H	J	K	L	M	N	P	Q
18	24	0.375	0.625	3.75	4 D	1.25	6	6.264	6.263	6	6	5.722	5.722	1.5
24	30	0.375	0.625	4.687	5 D	1.563	7.5	7.830	7.829	7.5	7.5	7.153	7.152	1.5
36	48	0.625	0.875	7.5	8 D	2.5	12	12.527	12.527	12	12	11.444	11.444	2.25
48	60	0.75	1.25	9.375	10 D	3.125	15	15.659	15.659	15	15	14.305	14.305	3

COLORS: LEGEND, BORDER — BLACK  
BACKGROUND — WHITE (RETROREFLECTIVE)

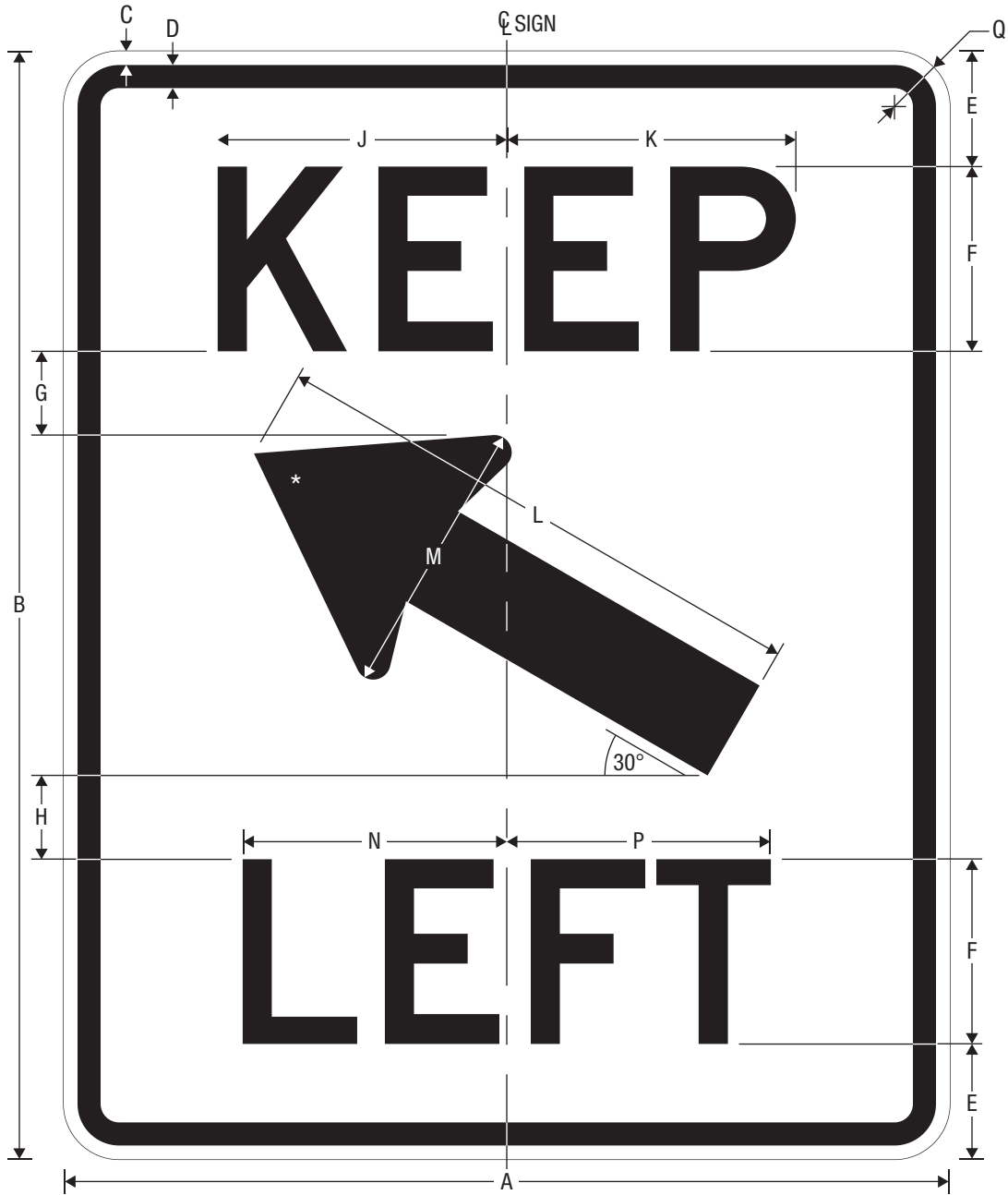

R4-8b  
KEEP LEFT

\* See page 7-3 for arrow design.

A	B	C	D	E	F	G	H	J	K	L	M	N	P	Q
18	24	0.375	0.625	2.5	4 D	1.814	1.814	6.264	6.263	12	6	5.722	5.722	1.5
24	30	0.375	0.625	3.125	5 D	2.268	2.268	7.830	7.829	15	7.5	7.153	7.152	1.5
36	48	0.625	0.875	5	8 D	3.629	3.628	12.527	12.527	24	12	11.444	11.444	2.25
48	60	0.75	1.25	6.25	10 D	4.536	4.536	15.659	15.659	30	15	14.305	14.305	3

COLORS: LEGEND, BORDER — BLACK  
BACKGROUND — WHITE (RETROREFLECTIVE)

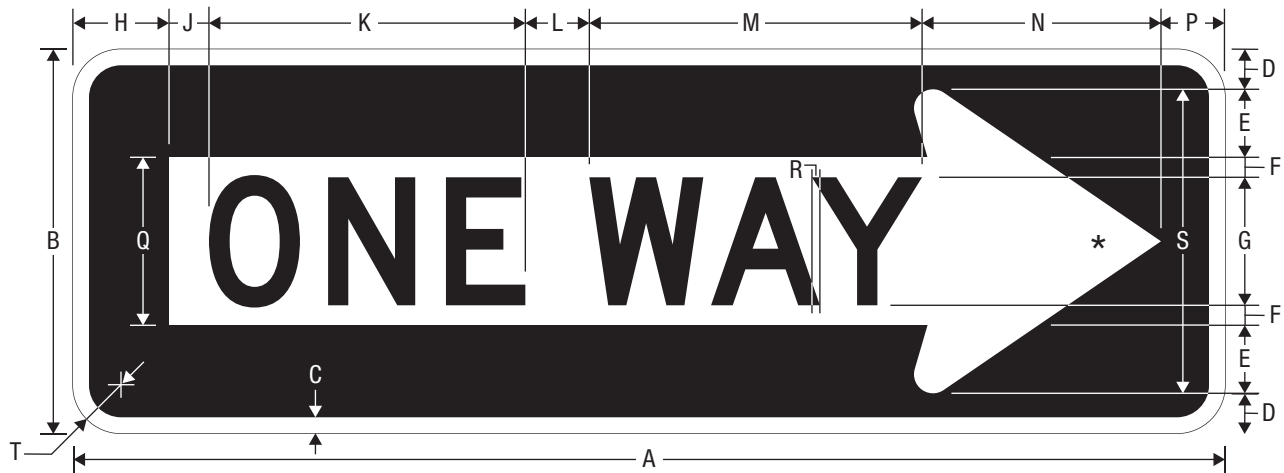

R6-1R  
ONE WAY

\* See page 7-3 for arrow design.

A	B	C	D	E	F	G	H	J
36	12	0.5	1.25	2.125	0.625	4 D	3	1.25
48	18	0.75	1.875	3.625	1	5 D	3.5	2.5
72	24	1	2.5	4.25	1.25	8 D	6	2.5

K	L	M	N	P	Q	R	S	T
9.886	2	10.398	7.466	2	5.25	0.248	9.5	1.5
12.358	3	12.997	11.144	2.5	7	0.311	14.25	1.875
19.772	4	20.796	14.932	4	10.5	0.496	19	3

COLORS: LEGEND, BACKGROUND — BLACK  
ARROW, BORDER — WHITE (RETROREFLECTIVE)

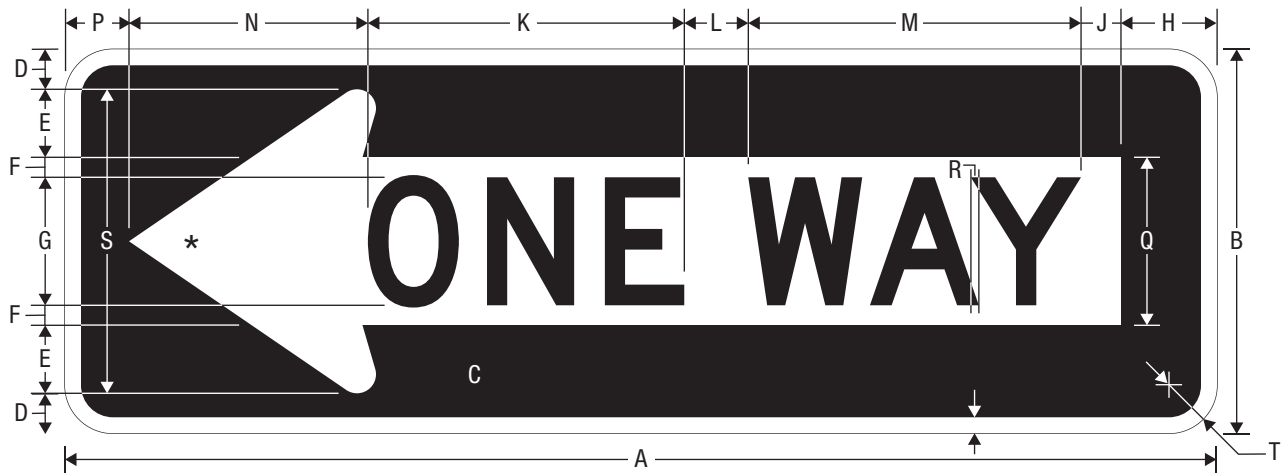

R6-1L  
ONE WAY

\* See page 7-3 for arrow design.

A	B	C	D	E	F	G	H	J
36	12	0.5	1.25	2.125	0.625	4 D	3	1.25
48	18	0.75	1.875	3.625	1	5 D	3.5	2.5
72	24	1	2.5	4.25	1.25	8 D	6	2.5

K	L	M	N	P	Q	R	S	T
9.886	2	10.398	7.466	2	5.25	0.248	9.5	1.5
12.358	3	12.997	11.144	2.5	7	0.311	14.25	1.875
19.772	4	20.796	14.932	4	10.5	0.496	19	3

COLORS: LEGEND, BACKGROUND — BLACK  
ARROW, BORDER — WHITE (RETROREFLECTIVE)



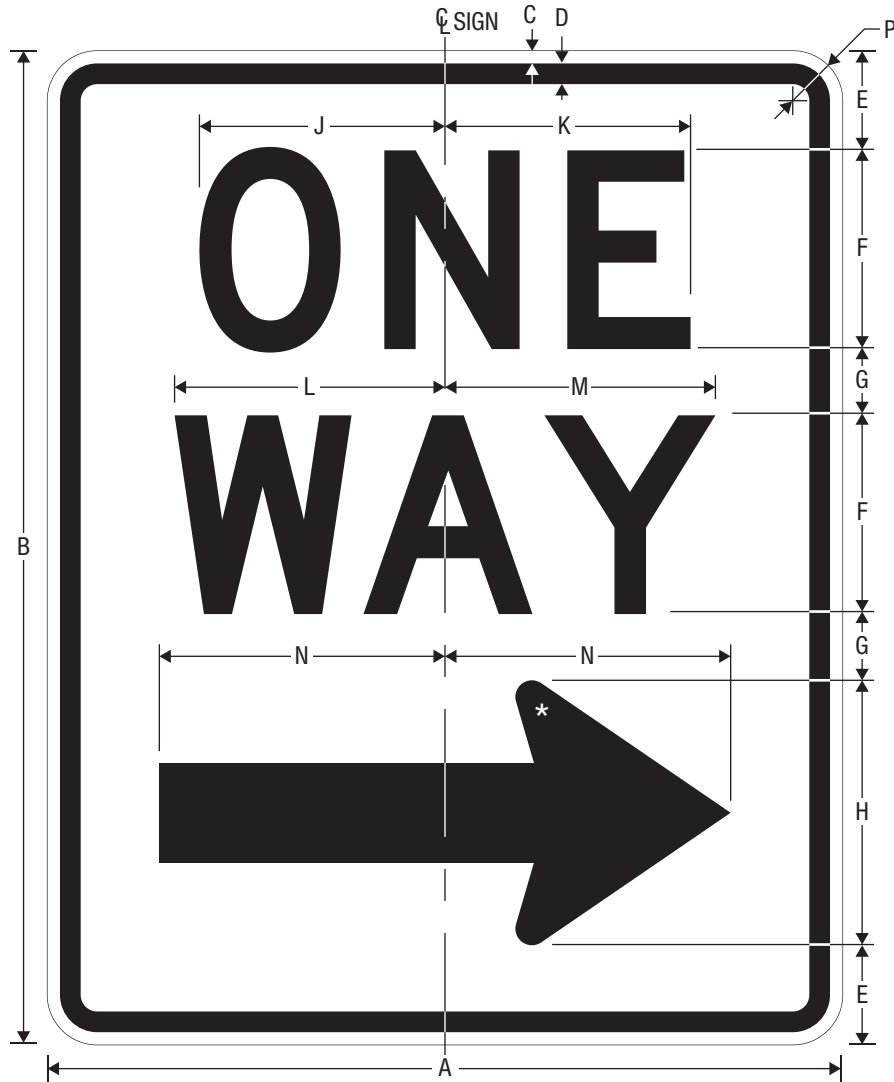

R6-2R  
ONE WAY



R6-2L  
ONE WAY

\* See page 7-3 for arrow design.

A	B	C	D	E	F	G	H	J	K	L	M	N	P
18	24	0.375	0.625	2.5	5 D	1.5	6	6.179	6.179	6.804	6.804	6.5	1.5
24	30	0.375	0.625	3	6 D	2	8	7.415	7.414	8.165	8.164	8.625	1.5
30	36	0.5	0.75	3.75	7 D	2.625	9.25	8.651	8.650	9.526	9.525	10	1.875
36	48	0.625	0.875	4.75	10 D	3	12.5	12.358	12.357	13.608	13.607	13.75	2.25
48	60	0.75	1.25	6	12 D	4	16	14.829	14.829	16.329	16.329	17.25	3

COLORS: LEGEND, BORDER — BLACK  
BACKGROUND — WHITE (RETROREFLECTIVE)

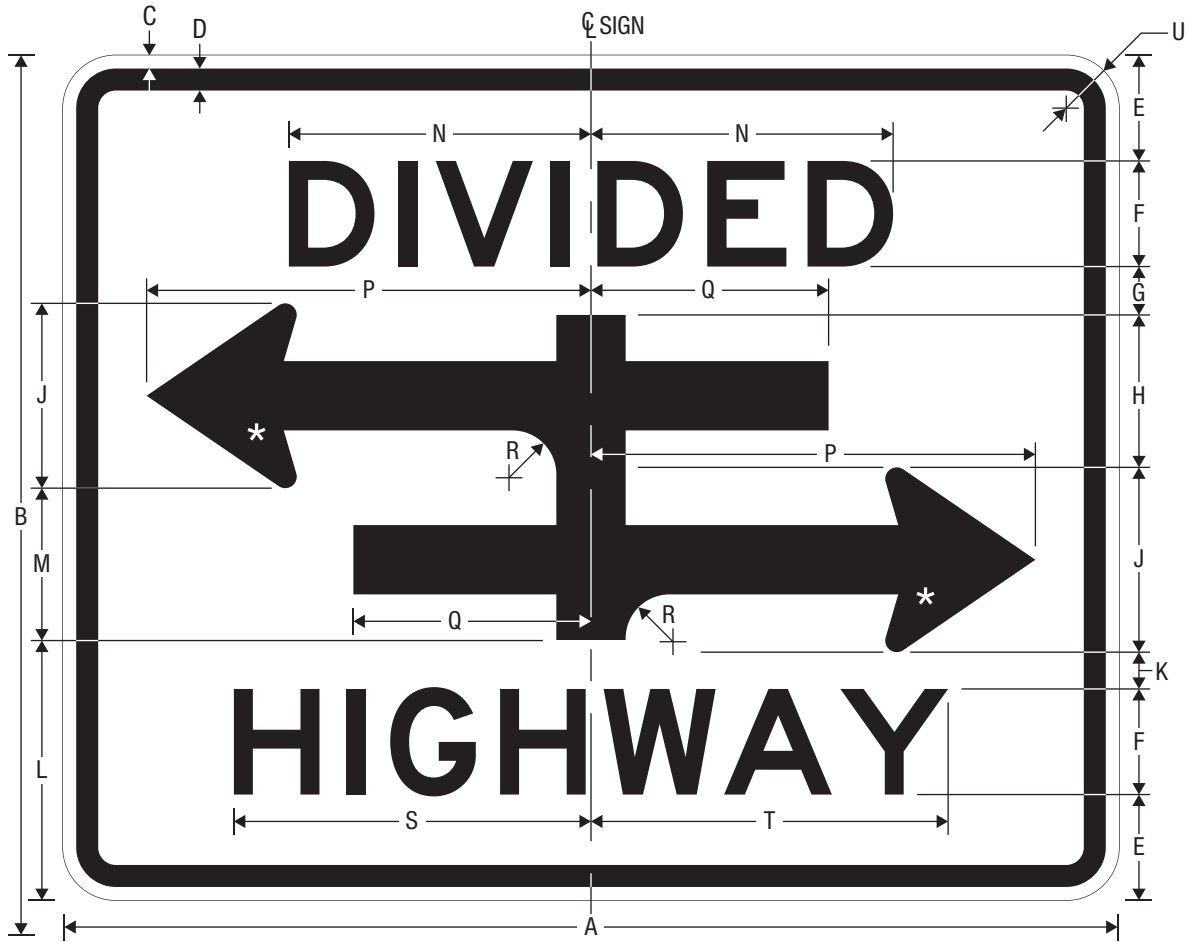

R6-3  
DIVIDED HIGHWAY CROSSING

\* See page 7-3 for arrow design.

A	B	C	D	E	F	G	H	J	K
30	24	0.375	0.625	3	3 E	1.375	4.330	5.25	1.045
36	30	0.5	0.75	3.5	4 E	1.75	5.385	6.5	1.366

L	M	N	P	Q	R	S	T	U
7.375	4.329	8.583	12.625	6.75	1.25	10.146	10.145	1.5
9.25	5.384	11.444	15.375	8.25	1.5	13.528	13.527	1.875

COLORS: LEGEND, BORDER — BLACK  
BACKGROUND — WHITE (RETROREFLECTIVE)

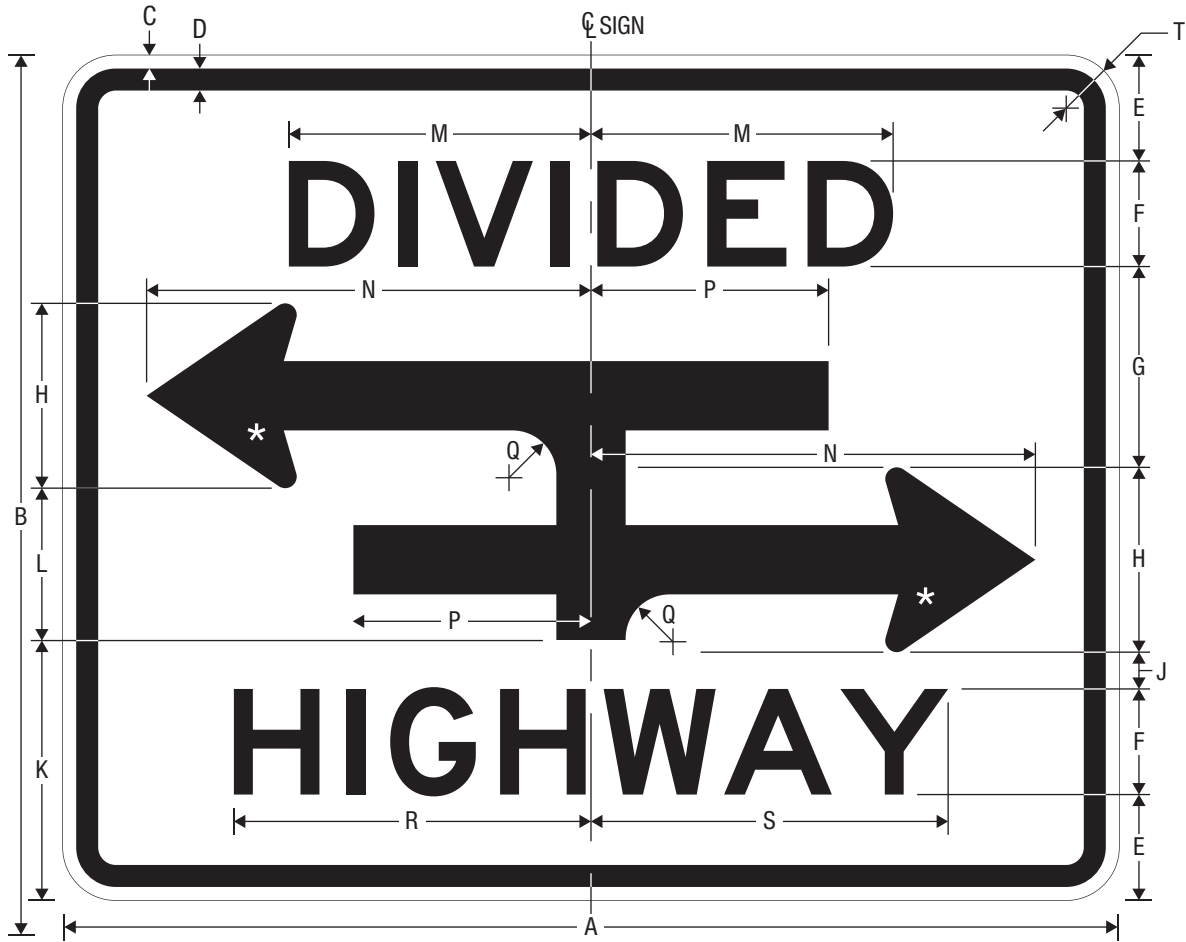

R6-3a  
DIVIDED HIGHWAY CROSSING

\* See page 7-3 for arrow design.

A	B	C	D	E	F	G	H	J
30	24	0.375	0.625	3	3 E	5.705	5.25	1.045
36	30	0.5	0.75	3.5	4 E	7.135	6.5	1.366

K	L	M	N	P	Q	R	S	T
7.375	4.329	8.583	12.625	6.75	1.25	10.146	10.145	1.5
9.25	5.384	11.444	15.375	8.25	1.5	13.528	13.527	1.875

COLORS: LEGEND, BORDER — BLACK  
BACKGROUND — WHITE (RETROREFLECTIVE)

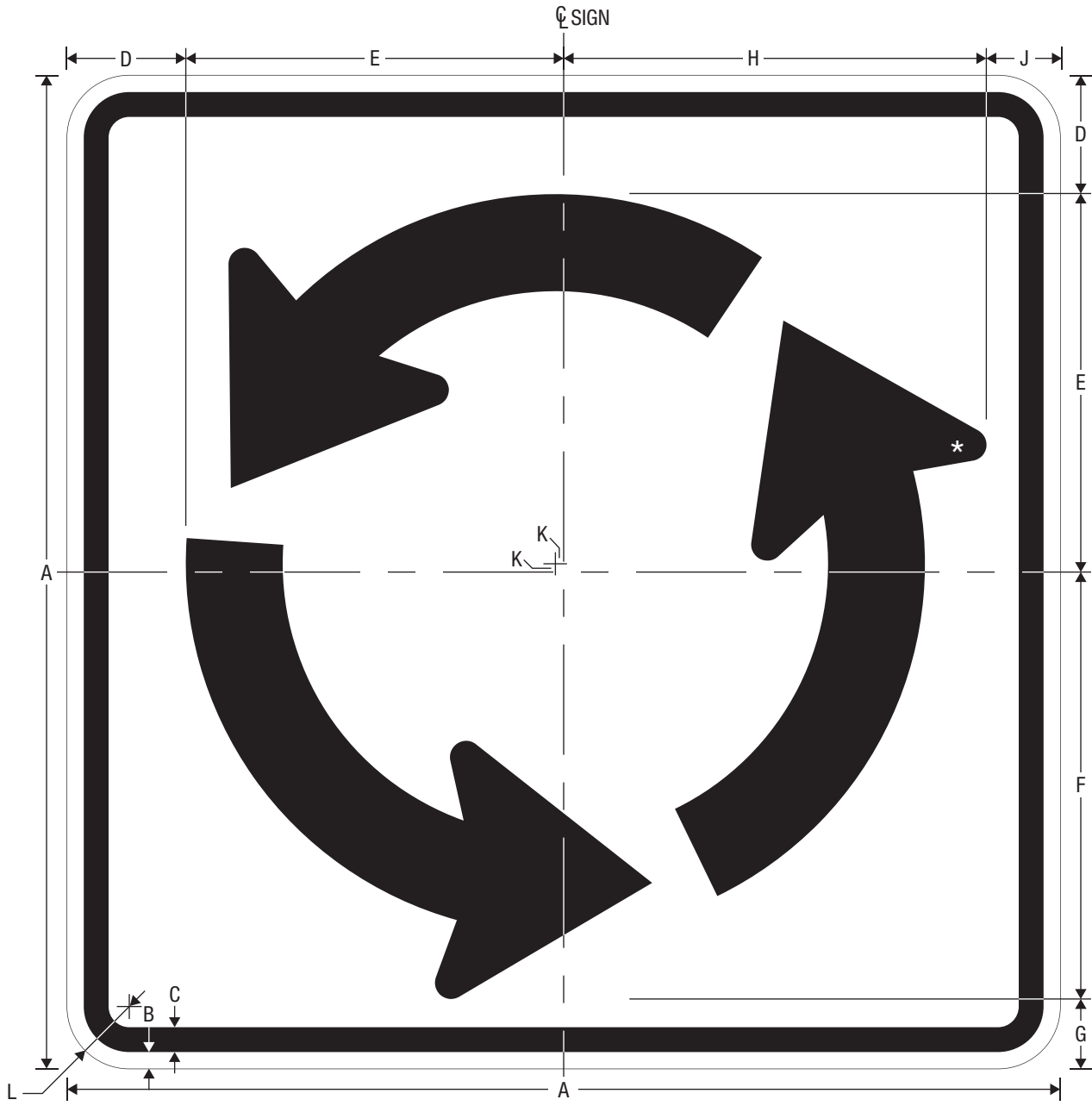

**R6-5P**  
ROUNDABOUT CIRCULATION (PLAQUE)

\* See page 8-50 for symbol design.

A	B	C	D	E	F	G	H	J	K	L
30	0.5	0.75	3.583	11.417	12.897	2.103	12.776	2.224	0.25	1.875

COLORS: LEGEND, BORDER – BLACK  
BACKGROUND – WHITE (RETROREFLECTIVE)



R8-10aL

STOP HERE WHEN FLASHING



R8-10aR

STOP HERE WHEN FLASHING

\* See 7-7 for arrow design.

\*\* Reduce Spacing 30%.

A	B	C	D	E	F	G	H	J	K	L
24	30	0.375	0.625	3	5 D	1.5	3 D	6.5	2	3 D**
36	42	0.625	0.875	4	7 D	2.5	4 D	10	2.5	4 D**

M	N	P	Q	R	S	T	U	V	W	X
8.75	7.75	7.806	7.805	4.773	9.375	6.992	1.627	8.670	8.679	1.5
11.375	11.625	10.928	10.928	6.364	14	10.550	2.169	11.560	11.572	2.25

COLORS: LEGEND, BORDER — BLACK  
BACKGROUND — WHITE (RETROREFLECTIVE)

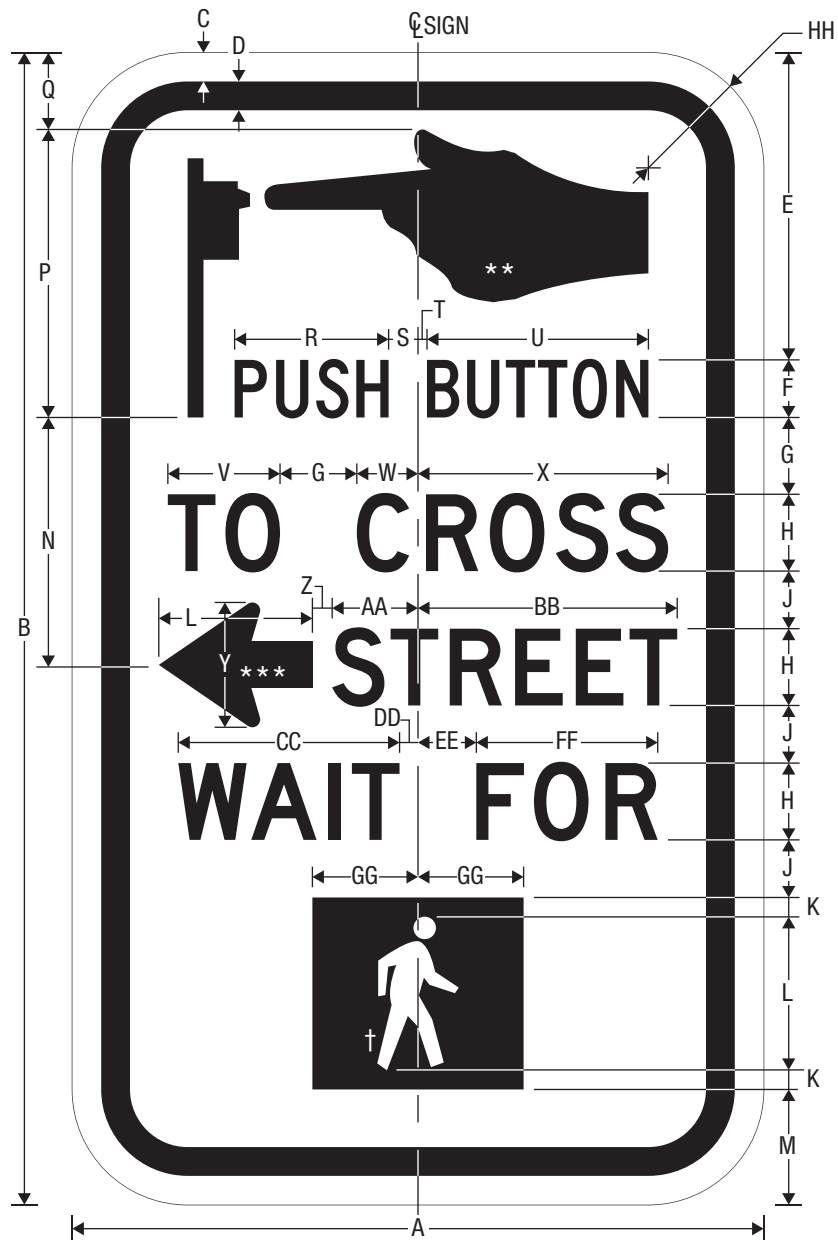

R10-3a

PUSH BUTTON TO CROSS STREET - WAIT FOR WALK SIGNAL

\* Reduce Spacing 20%.

\*\*\* See page 7-3 for arrow design.

\*\* See page 8-63 for symbol design.

† See page 8-7 for symbol design.

A	B	C	D	E	F	G	H	J	K	L
9	15	0.375	0.375	4	0.75 C*	1	1 D	0.75	0.25	2

M	N	P	Q	R	S	T	U	V	W	X
1.5	3.25	3.75	1	2.005	0.383	0.117	2.883	1.461	0.797	3.257

Y	Z	AA	BB	CC	DD	EE	FF	GG	HH
1.625	0.258	1.118	3.375	2.881	0.240	0.760	2.362	1.375	1.5

COLORS: LEGEND, BORDER – BLACK      PED SYMBOL – WHITE (RETROREFLECTIVE) ON BLACK  
 BACKGROUND – WHITE (RETROREFLECTIVE)

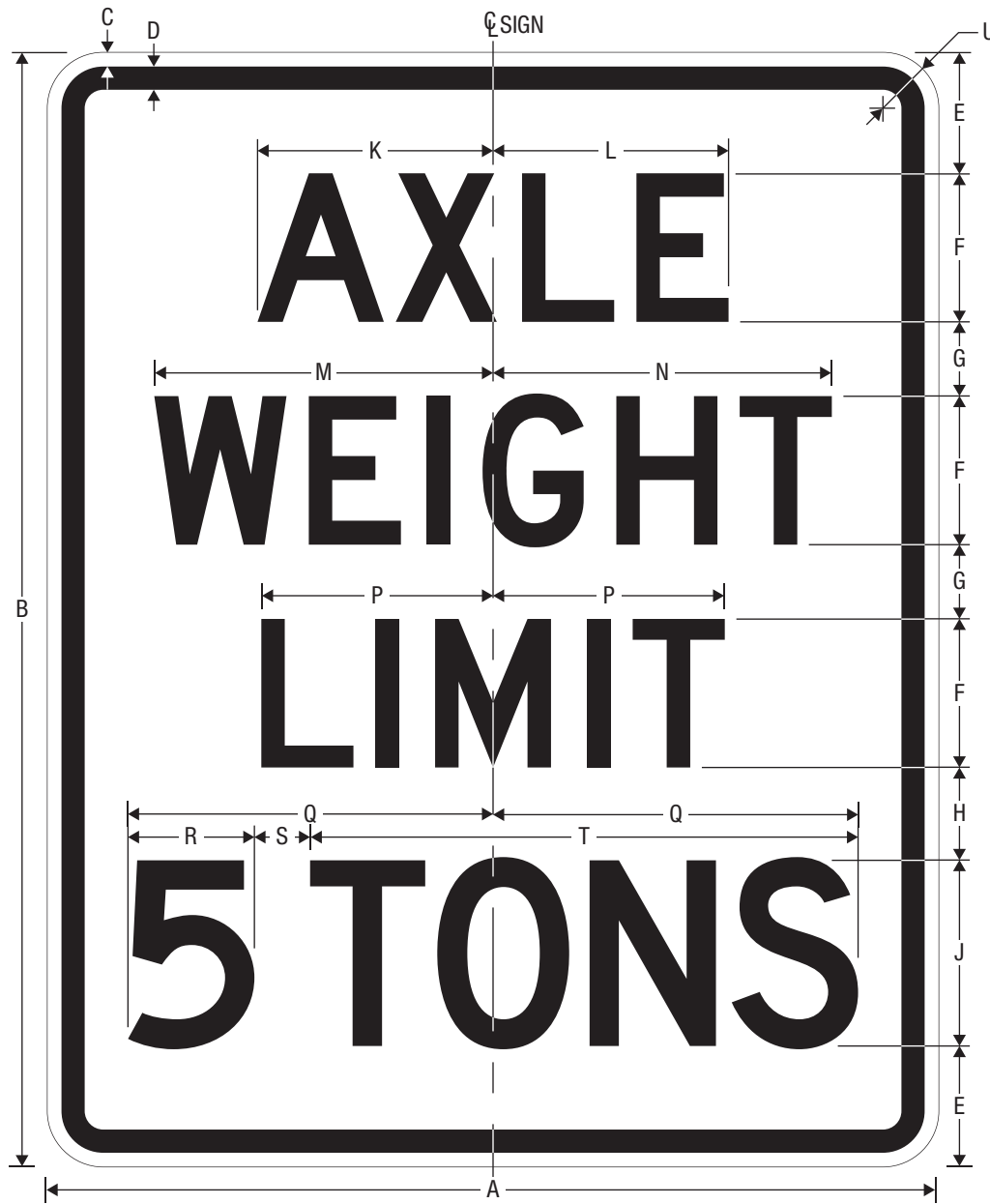

R12-2  
WEIGHT LIMIT

\* Reduce Spacing 50%.

A	B	C	D	E	F	G	H	J	K
24	30	0.375	0.625	3.25	4 D	2	2.5	5 D*	6.344
36	48	0.625	0.875	5.25	6 D	3.5	4.5	8 D*	9.516

L	M	N	P	Q	R	S	T	U
6.343	9.125	9.125	6.242	VAR	VAR	1.5	14.761	1.5
9.515	13.688	13.687	9.363	VAR	VAR	2.25	23.618	2.25

COLORS: LEGEND, BORDER — BLACK  
BACKGROUND — WHITE (RETROREFLECTIVE)

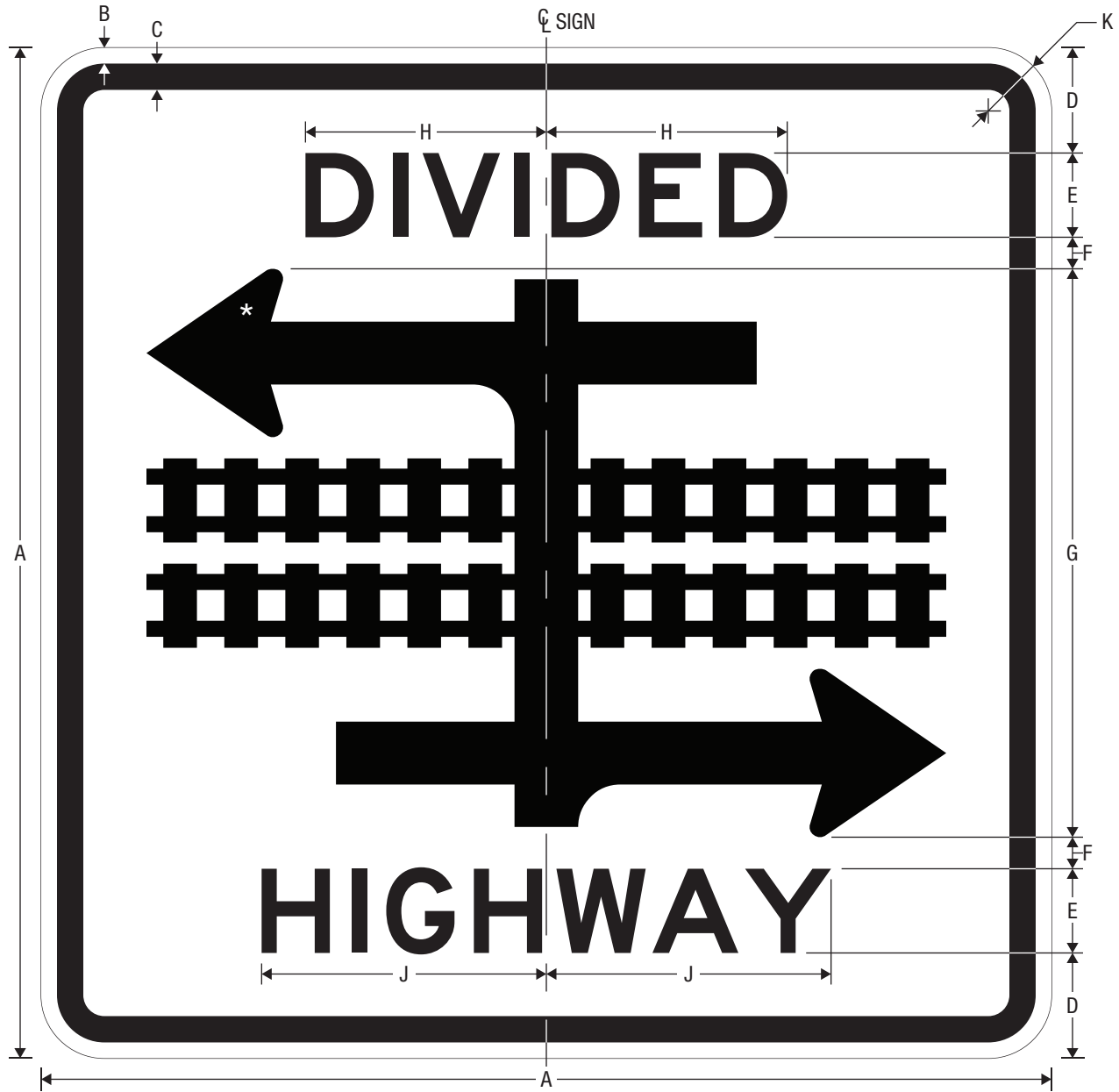

R15-7

LIGHT RAIL DIVIDED HIGHWAY SYMBOL

\* See page 8-26 for symbol design.

A	B	C	D	E	F	G	H	J	K
24	0.375	0.625	2.5	2 E	0.75	13.5	5.722	6.764	1.5

COLORS: LEGEND, BORDER — BLACK  
BACKGROUND — WHITE (RETROREFLECTIVE)

2-398



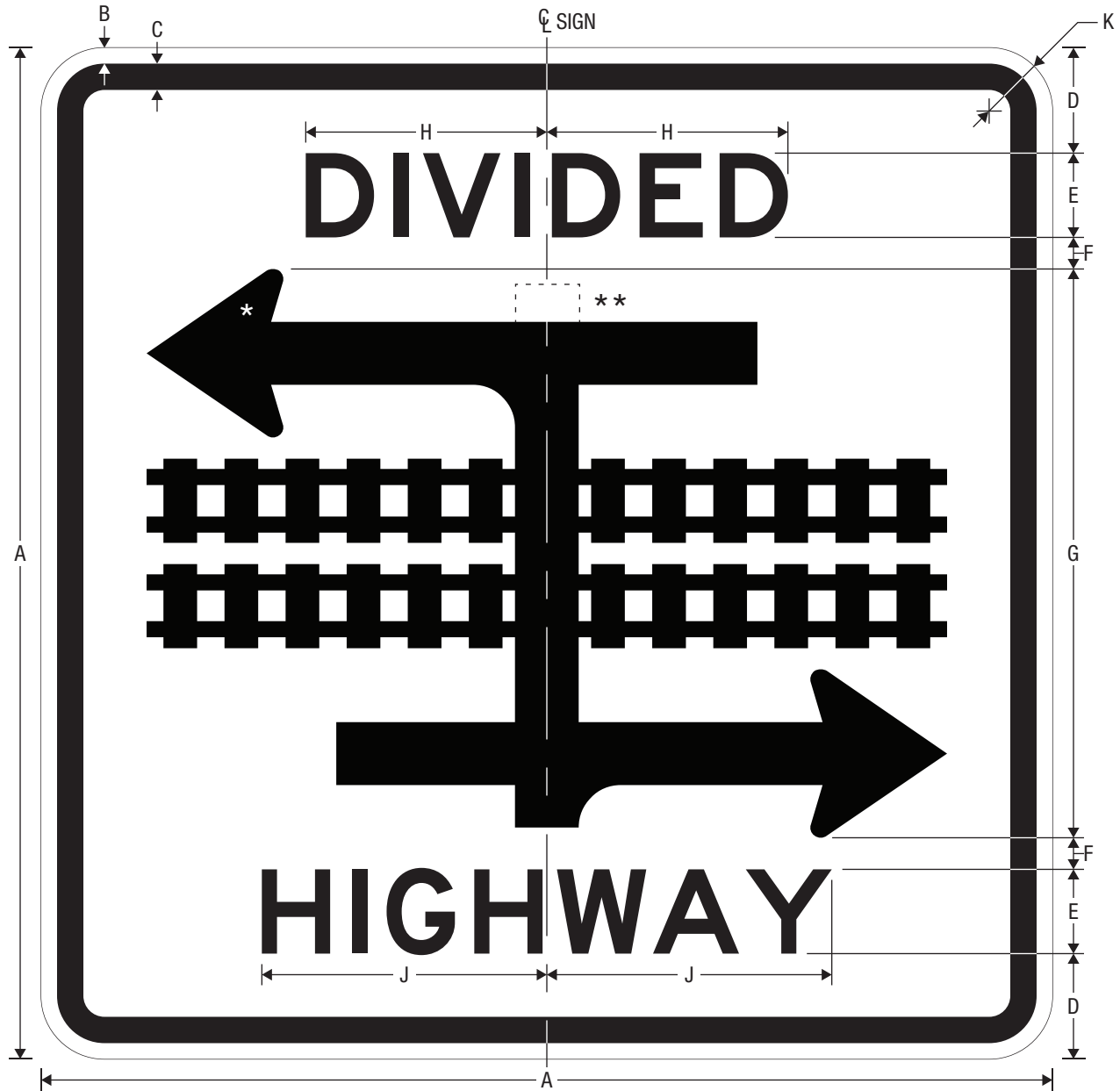

R15-7a

LIGHT RAIL DIVIDED HIGHWAY SYMBOL (T-INTERSECTION)

\* See page 8-26 for symbol design.

\*\* Modified symbol to show T-intersection.

A	B	C	D	E	F	G	H	J	K
24	0.375	0.625	2.5	2 E	0.75	13.5	5.722	6.764	1.5

COLORS: LEGEND, BORDER — BLACK  
BACKGROUND — WHITE (RETROREFLECTIVE)

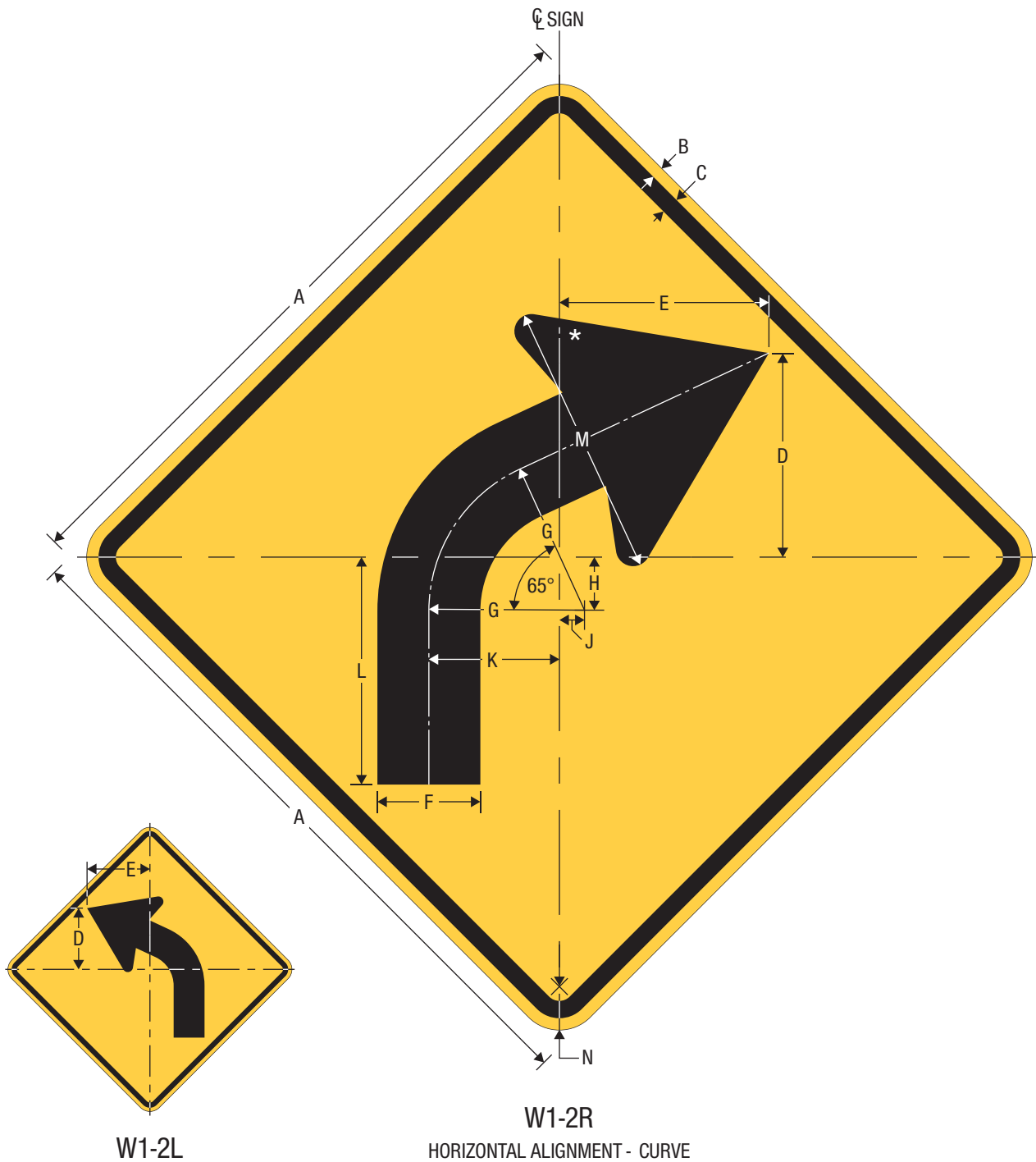

\* See page 7-3 for arrow design.

A	B	C	D	E	F	G	H	J	K	L	M	N
18	0.375	0.625	5.294	5.437	2.672	4.050	1.402	0.662	3.388	5.875	7.125	1.5
30	0.5	0.75	8.823	9.062	4.453	6.75	2.337	1.103	5.647	9.792	11.875	1.875
36	0.625	0.875	10.587	10.875	5.344	8.100	2.804	1.324	6.776	11.75	14.25	2.25
48	0.75	1.25	14.116	14.5	7.125	10.800	3.739	1.765	9.035	15.667	19	3

WARNING SIGN  
 COLORS: LEGEND, BORDER – BLACK  
 BACKGROUND – YELLOW (RETROREFLECTIVE)

TTC SIGN  
 COLORS: LEGEND, BORDER – BLACK  
 BACKGROUND – ORANGE (RETROREFLECTIVE)

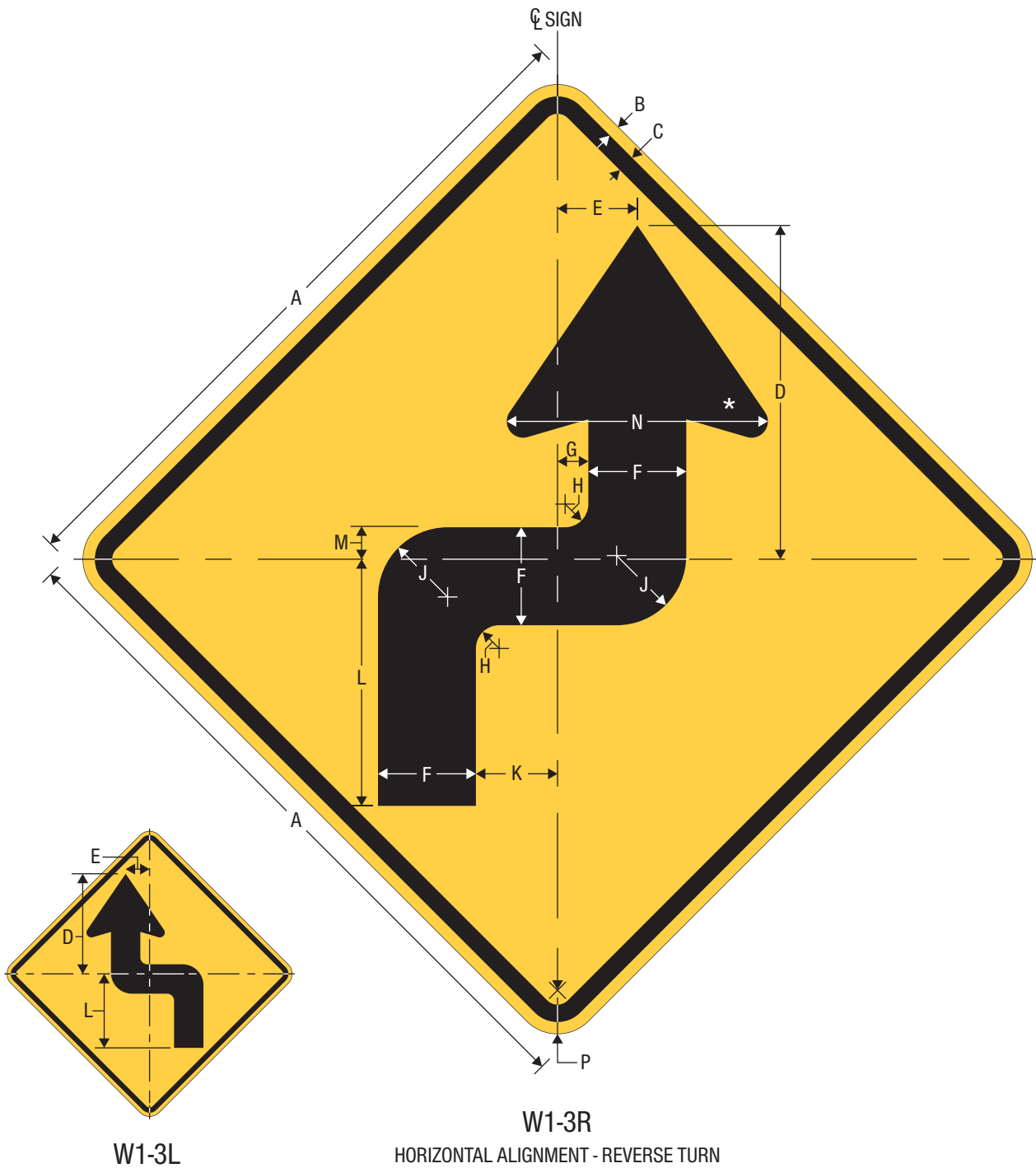

\* See page 7-3 for arrow design.

A	B	C	D	E	F	G	H	J	K	L	M	N	P
18	0.375	0.625	8.625	2.063	2.531	0.797	0.600	1.800	2.109	6.375	0.825	6.75	1.5
30	0.5	0.75	14.375	3.438	4.219	1.328	1	3	3.516	10.625	1.375	11.25	1.875
36	0.625	0.875	17.25	4.125	5.063	1.594	1.200	3.600	4.219	12.75	1.650	13.5	2.25
48	0.75	1.25	23	5.5	6.75	2.125	1.600	4.800	5.625	17	2.200	18	3

WARNING SIGN  
 COLORS: LEGEND, BORDER – BLACK  
 BACKGROUND – YELLOW (RETROREFLECTIVE)

TTC SIGN  
 COLORS: LEGEND, BORDER – BLACK  
 BACKGROUND – ORANGE (RETROREFLECTIVE)

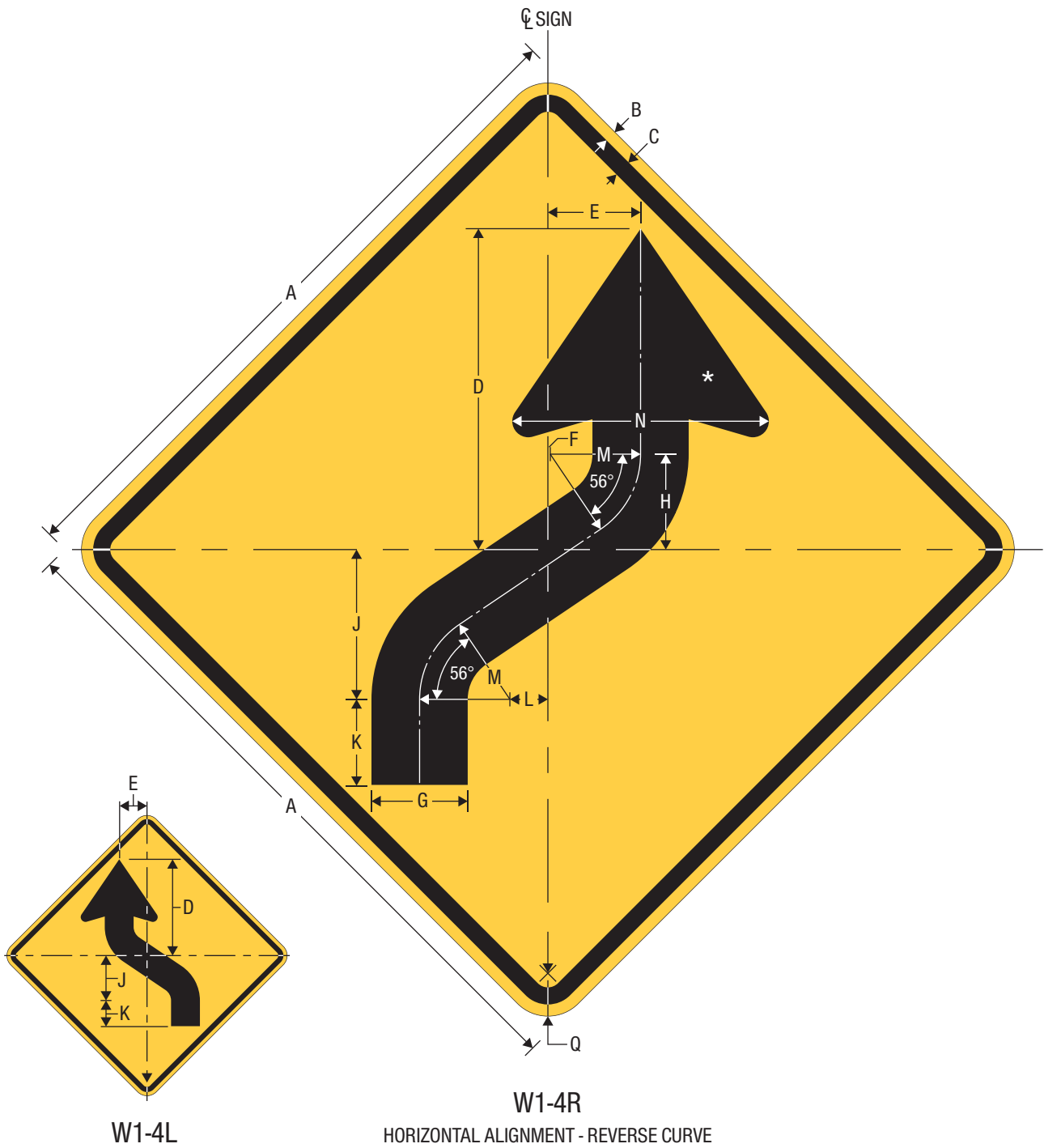

\* See page 7-3 for arrow design.

A	B	C	D	E	F	G	H	J	K	L	M	N	P
18	0.375	0.625	8.438	2.438	0.063	2.531	2.509	3.938	2.25	1	2.375	6.75	1.5
30	0.5	0.75	14.062	4.063	0.104	4.219	4.181	6.562	3.75	1.667	3.958	11.25	1.875
36	0.625	0.875	16.875	4.875	0.125	5.063	5.017	7.875	4.5	2	4.75	13.5	2.25
48	0.75	1.25	22.5	6.5	0.167	6.75	6.690	10.5	6	2.667	6.333	18	3

WARNING SIGN  
COLORS: LEGEND, BORDER – BLACK  
BACKGROUND – YELLOW (RETROREFLECTIVE)

TTC SIGN  
COLORS: LEGEND, BORDER – BLACK  
BACKGROUND – ORANGE (RETROREFLECTIVE)

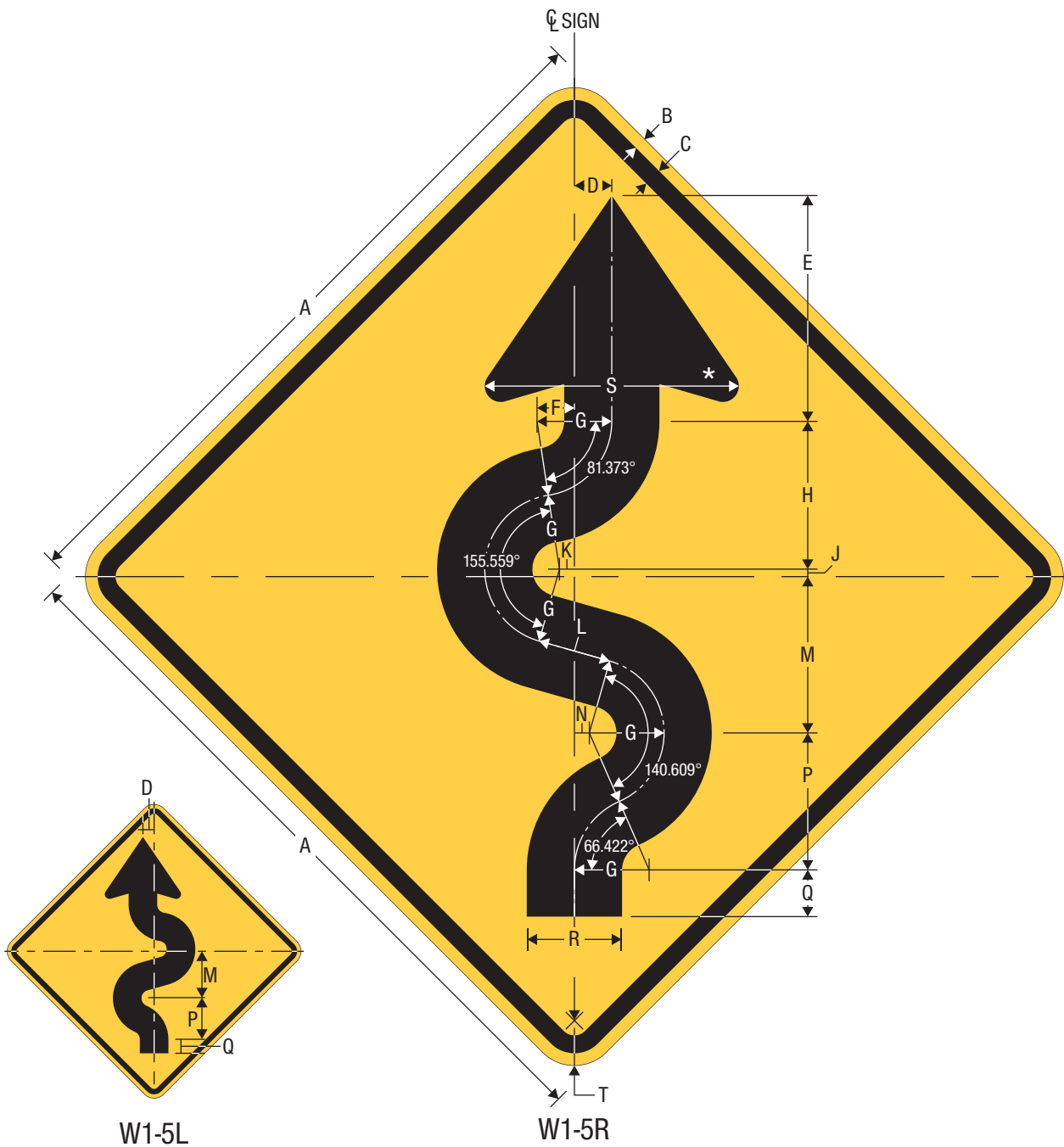

W1-5L

W1-5R

HORIZONTAL ALIGNMENT - WINDING ROAD

\* See page 7-3 for arrow design.

A	B	C	D	E	F	G	H	J
18	0.375	0.625	0.938	5.667	0.937	1.875	3.708	0.188
30	0.5	0.75	1.562	9.446	1.562	3.125	6.179	0.313
36	0.625	0.875	1.875	11.335	1.875	3.75	7.145	0.375
48	0.75	1.25	2.5	15.113	2.5	5	9.887	0.5

K	L	M	N	P	Q	R	S	T
0.375	1.842	3.922	0.375	3.437	1.172	2.391	6.375	1.5
0.625	3.069	6.537	0.625	5.728	1.953	3.984	10.625	1.875
0.75	3.683	7.845	0.75	6.874	2.344	4.781	12.75	2.25
1	4.911	10.460	1	9.165	3.125	6.375	17	3

WARNING SIGN

COLORS: LEGEND, BORDER — BLACK  
BACKGROUND — YELLOW (RETROREFLECTIVE)

TTC SIGN

COLORS: LEGEND, BORDER — BLACK  
BACKGROUND — ORANGE (RETROREFLECTIVE)

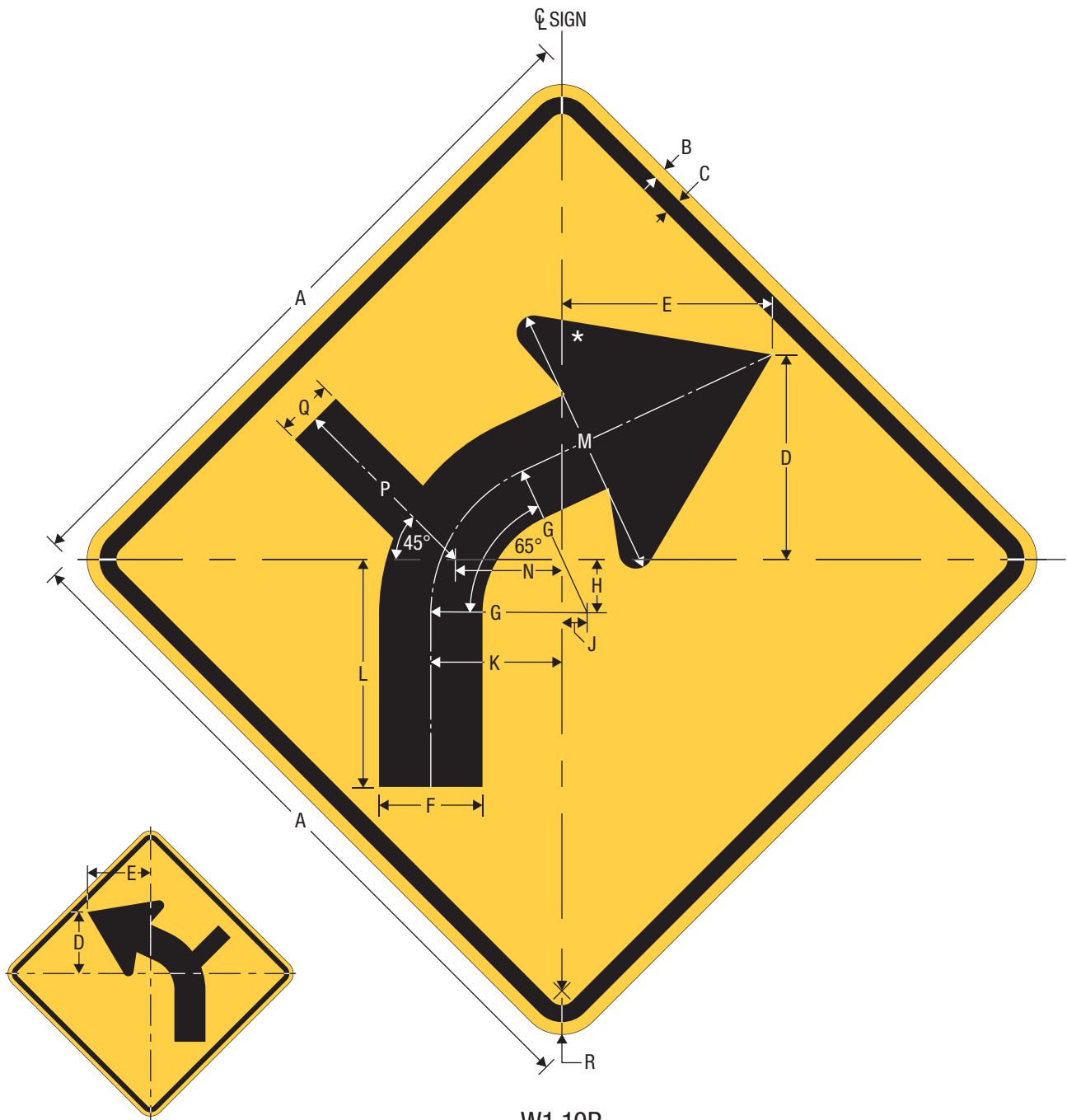

W1-10L

W1-10R

COMBINATION HORIZONTAL ALIGNMENT/INTERSECTION

\* See page 7-3 for arrow design.

A	B	C	D	E	F	G	H
36	0.625	0.875	10.587	10.875	5.344	8.100	2.804
48	0.75	1.25	14.116	14.5	7.125	10.800	3.739

J	K	L	M	N	P	Q	R
1.324	6.776	11.75	14.25	5.5	10.25	3	2.25
1.765	9.035	15.667	19	7.333	13.667	4	3

WARNING SIGN

COLORS: LEGEND, BORDER – BLACK  
BACKGROUND – YELLOW (RETROREFLECTIVE)

TTC SIGN

COLORS: LEGEND, BORDER – BLACK  
BACKGROUND – ORANGE (RETROREFLECTIVE)

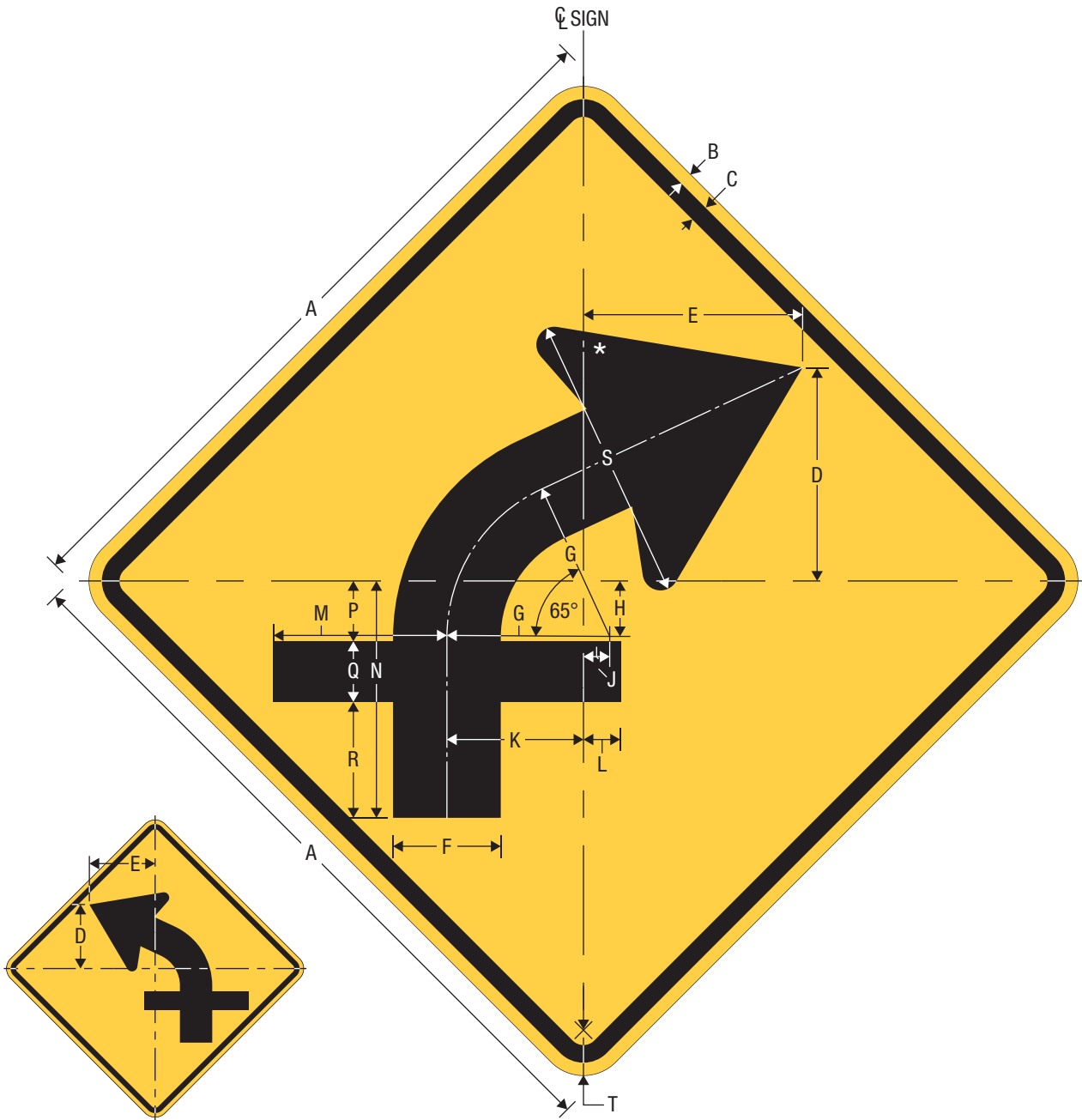

W1-10aL

W1-10aR

COMBINATION HORIZONTAL ALIGNMENT/INTERSECTION

\* See page 7-3 for arrow design.

A	B	C	D	E	F	G	H	J
36	0.625	0.875	10.587	10.875	5.344	8.100	2.804	1.324
48	0.75	1.25	14.116	14.5	7.125	10.800	3.739	1.765

K	L	M	N	P	Q	R	S	T
6.776	1.849	8.625	11.75	3	3	5.75	14.25	2.25
9.035	2.465	11.5	15.667	4	4	7.667	19	3

COLORS: LEGEND, BORDER – BLACK  
BACKGROUND – YELLOW (RETROREFLECTIVE)

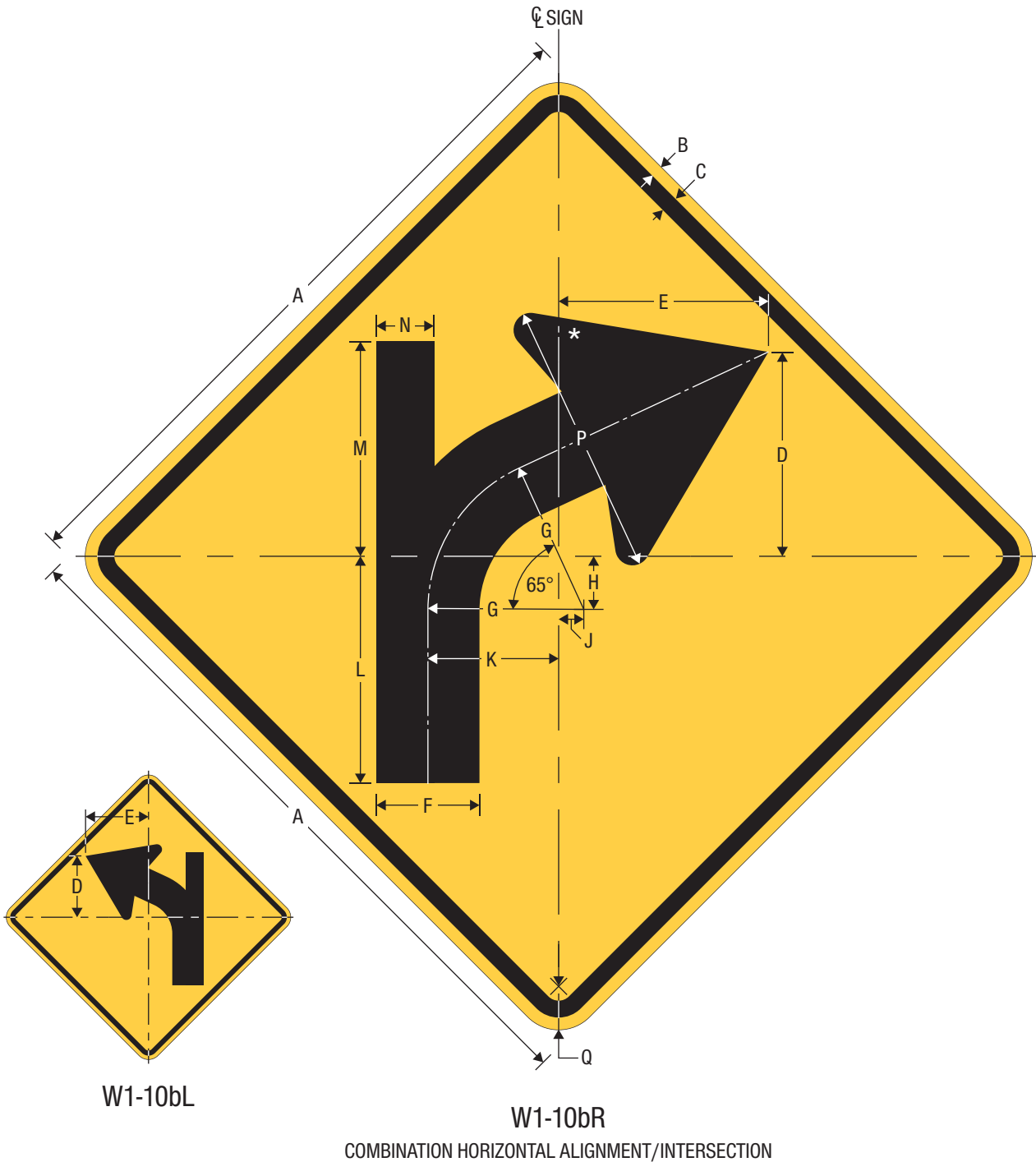

\* See page 7-3 for arrow design.

A	B	C	D	E	F	G	H	J	K	L	M	N	P	Q
36	0.625	0.875	10.587	10.875	5.344	8.100	2.804	1.324	6.776	11.75	11.125	3	14.25	2.25
48	0.75	1.25	14.116	14.5	7.125	10.800	3.739	1.765	9.035	15.667	14.833	4	19	3

COLORS: LEGEND, BORDER – BLACK  
BACKGROUND – YELLOW (RETROREFLECTIVE)



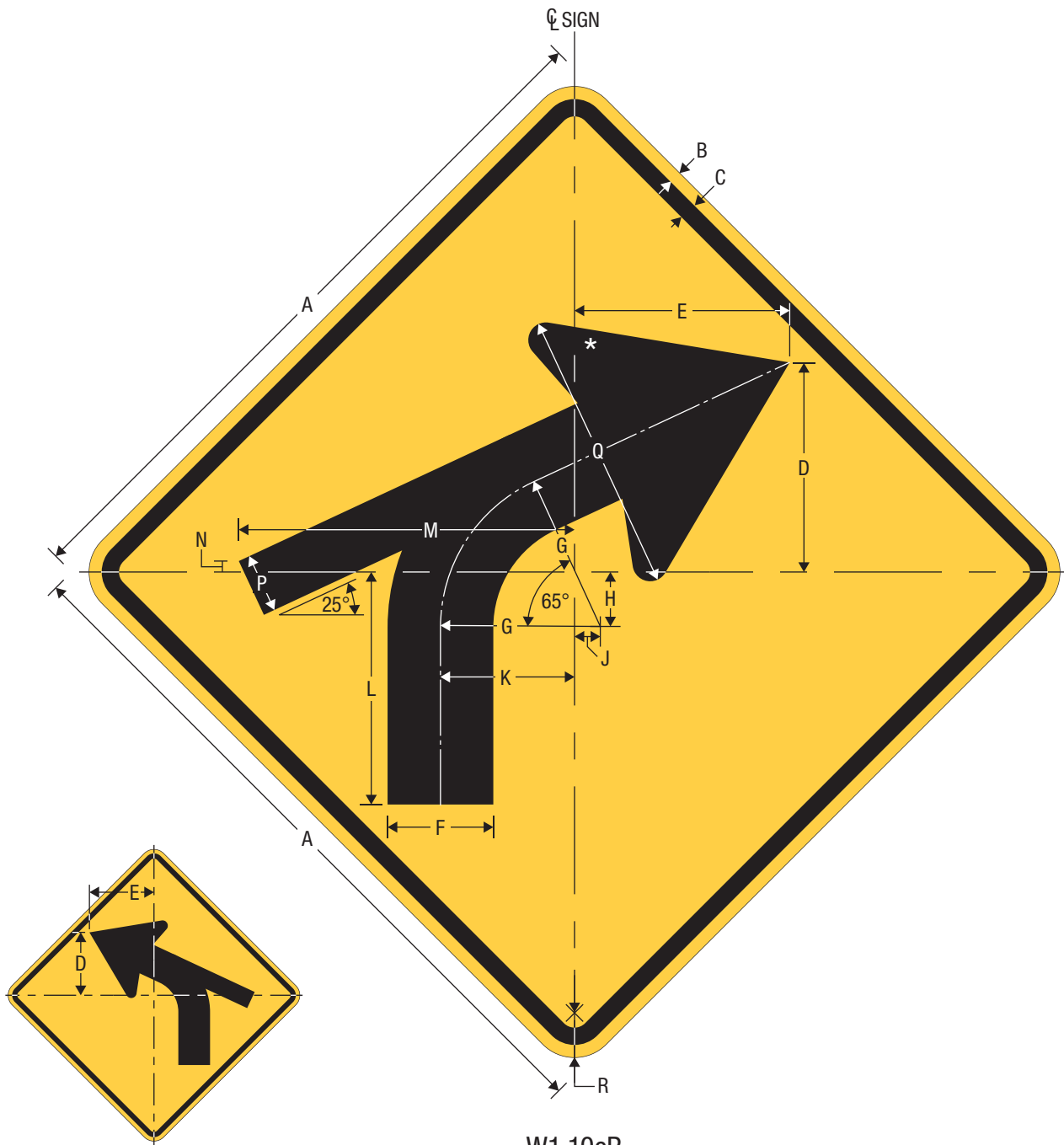

W1-10cL

W1-10cR

COMBINATION HORIZONTAL ALIGNMENT/INTERSECTION

\* See page 7-3 for arrow design.

A	B	C	D	E	F	G	H
36	0.625	0.875	10.587	10.875	5.344	8.100	2.804
48	0.75	1.25	14.116	14.5	7.125	10.800	3.739

J	K	L	M	N	P	Q	R
1.324	6.776	11.75	16.967	0.552	3	14.25	2.25
1.765	9.035	15.667	22.622	0.737	4	19	3

COLORS: LEGEND, BORDER — BLACK  
BACKGROUND — YELLOW (RETROREFLECTIVE)

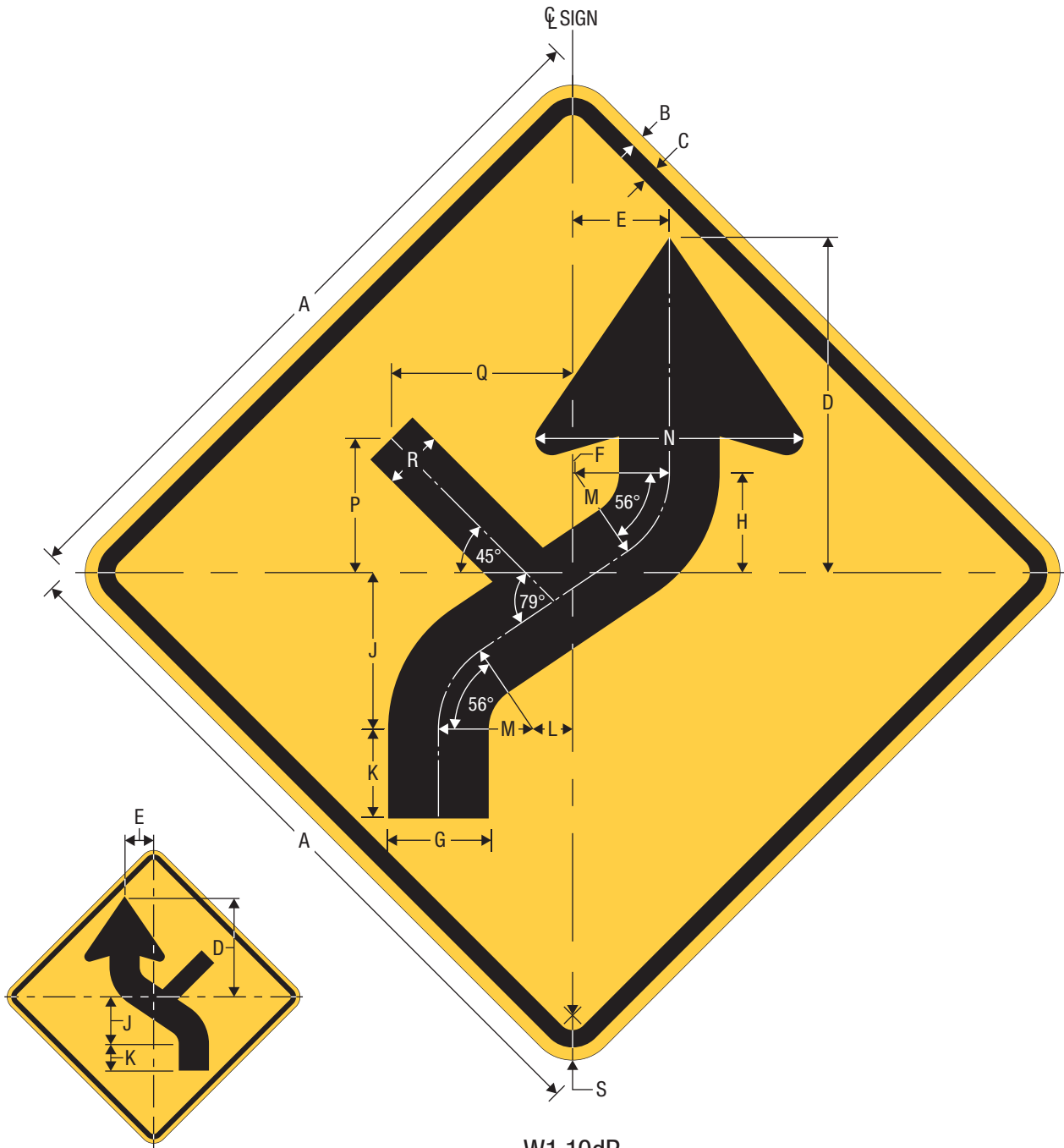

W1-10dL

W1-10dR

COMBINATION HORIZONTAL ALIGNMENT/INTERSECTION

\* See page 7-3 for arrow design.

A	B	C	D	E	F	G	H	J
36	0.625	0.875	16.875	4.875	0.125	5.063	5.017	7.875
48	0.75	1.25	22.5	6.5	0.167	6.75	6.690	10.5

K	L	M	N	P	Q	R	S
4.5	2	4.75	13.5	6.75	9.116	3	2.25
6	2.667	6.333	18	9	12.155	4	3

COLORS: LEGEND, BORDER — BLACK  
BACKGROUND — YELLOW (RETROREFLECTIVE)

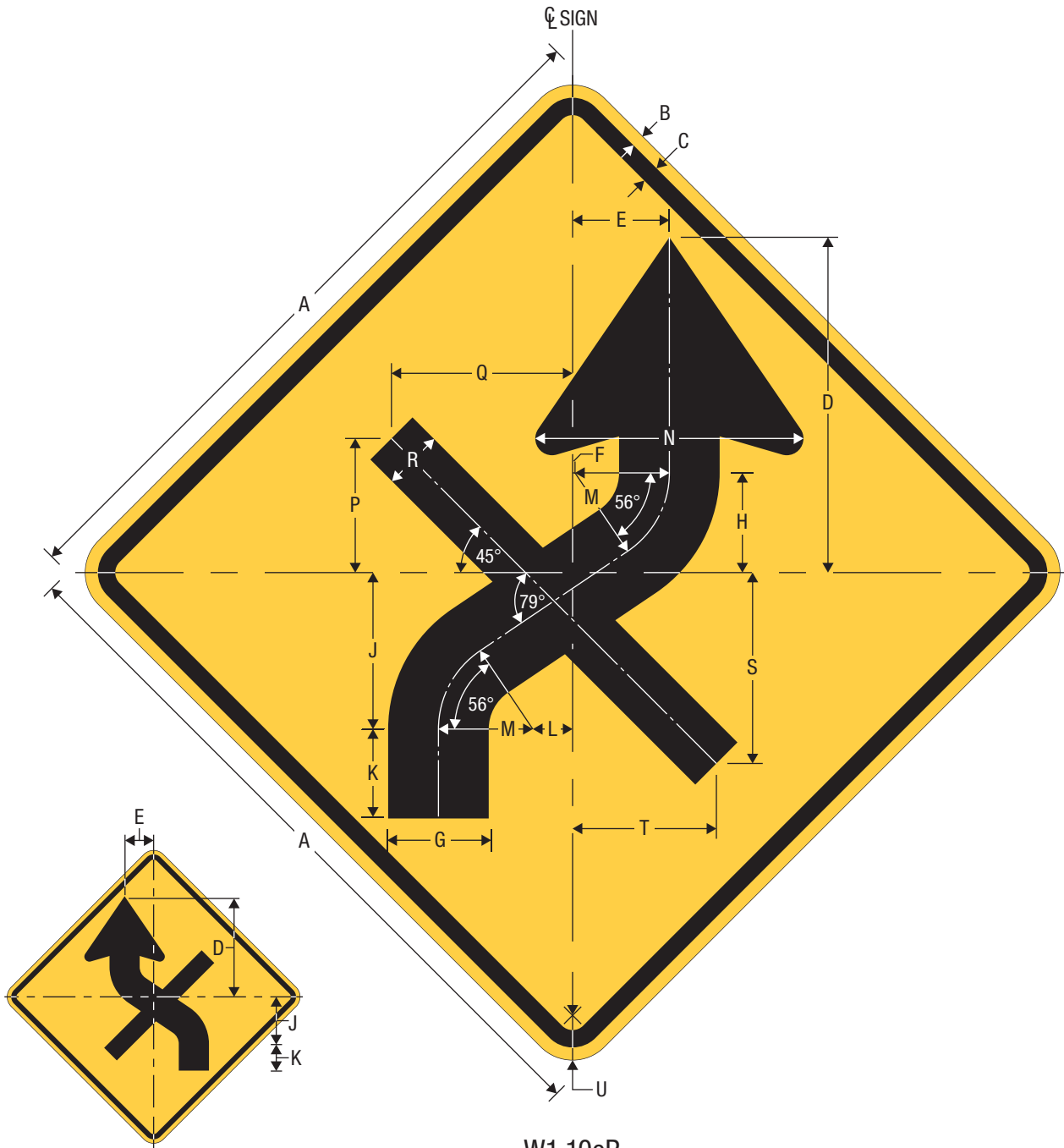

W1-10eL

W1-10eR

COMBINATION HORIZONTAL ALIGNMENT/INTERSECTION

\* See page 7-3 for arrow design.

A	B	C	D	E	F	G	H	J	K
36	0.625	0.875	16.875	4.875	0.125	5.063	5.017	7.875	4.5
48	0.75	1.25	22.5	6.5	0.167	6.75	6.690	10.5	6

L	M	N	P	Q	R	S	T	U
2	4.75	13.5	6.75	9.116	3	9.608	7.241	2.25
2.667	6.333	18	9	12.155	4	12.810	9.655	3

COLORS: LEGEND, BORDER — BLACK  
BACKGROUND — YELLOW (RETROREFLECTIVE)

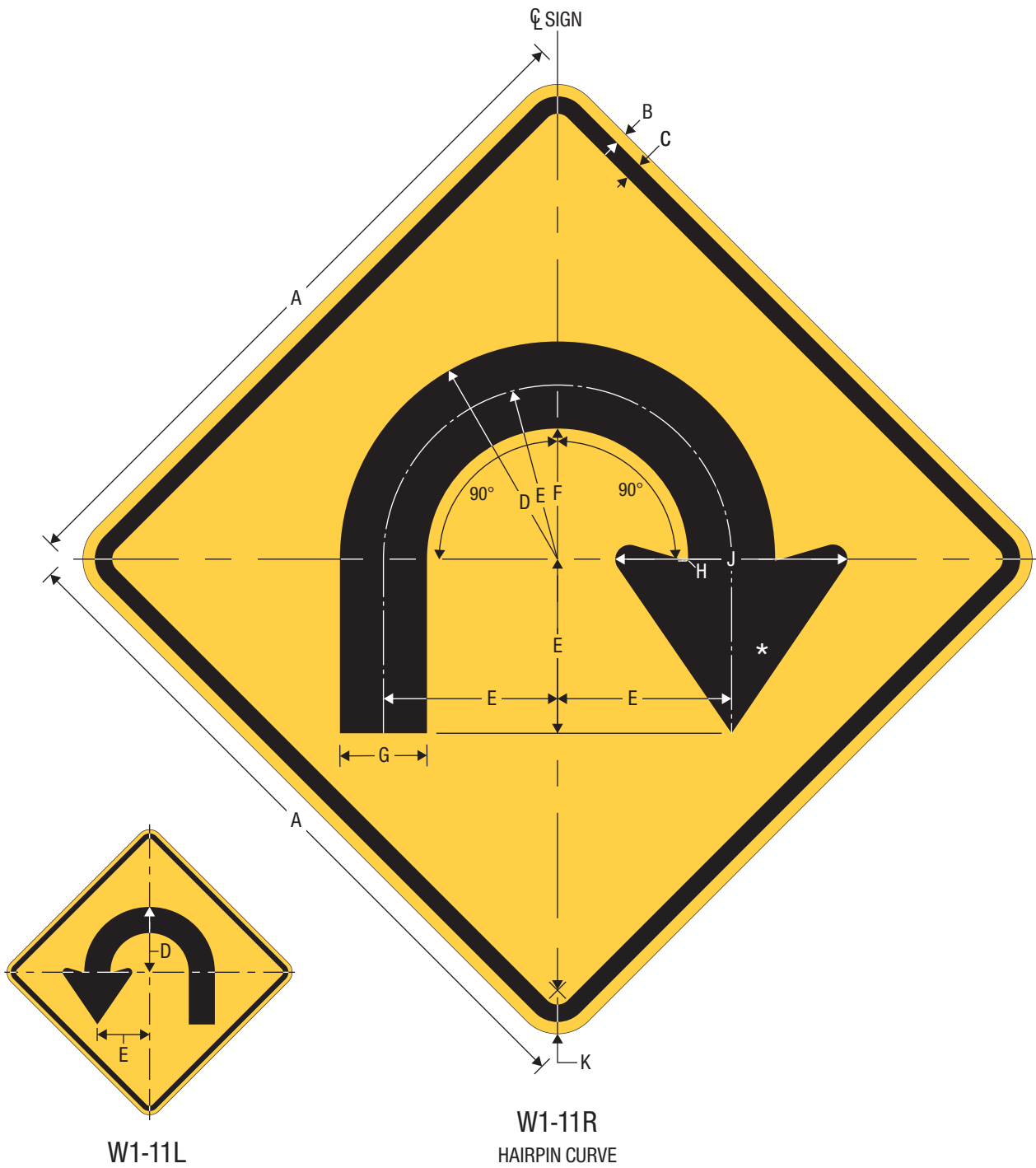

\* See page 7-3 for arrow design.

A	B	C	D	E	F	G	H	J	K
30	0.5	0.75	9.375	7.5	5.625	3.75	0.078	10	1.875
36	0.625	0.875	11.25	9	6.75	4.5	0.094	12	2.25
48	0.75	1.25	15	12	9	6	0.125	16	3

COLORS: LEGEND, BORDER — BLACK  
BACKGROUND — YELLOW (RETROREFLECTIVE)

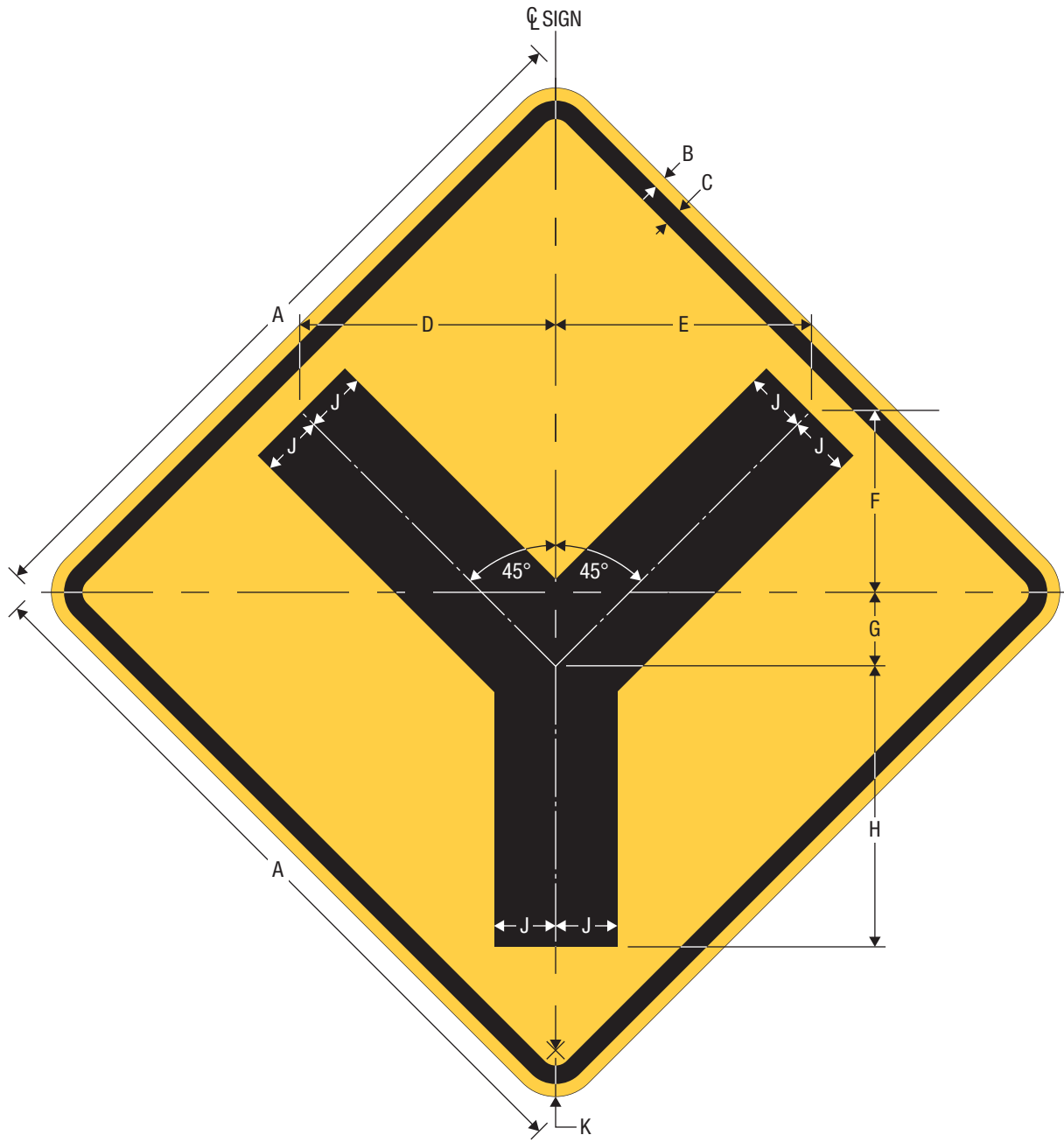

**W2-5**  
INTERSECTION WARNING - Y-INTERSECTION

A	B	C	D	E	F	G	H	J	K
18	0.375	0.625	6.188	6.187	4.422	1.797	6.828	1.5	1.5
24	0.375	0.625	8.25	8.25	5.906	2.406	9.094	2	1.5
30	0.5	0.75	10.313	10.312	7.375	3	11.375	2.5	1.875
36	0.625	0.875	12.375	12.375	8.844	3.594	13.656	3	2.25
48	0.75	1.25	16.5	16.5	11.813	4.812	18.188	4	3

COLORS: LEGEND, BORDER — BLACK  
BACKGROUND — YELLOW (RETROREFLECTIVE)

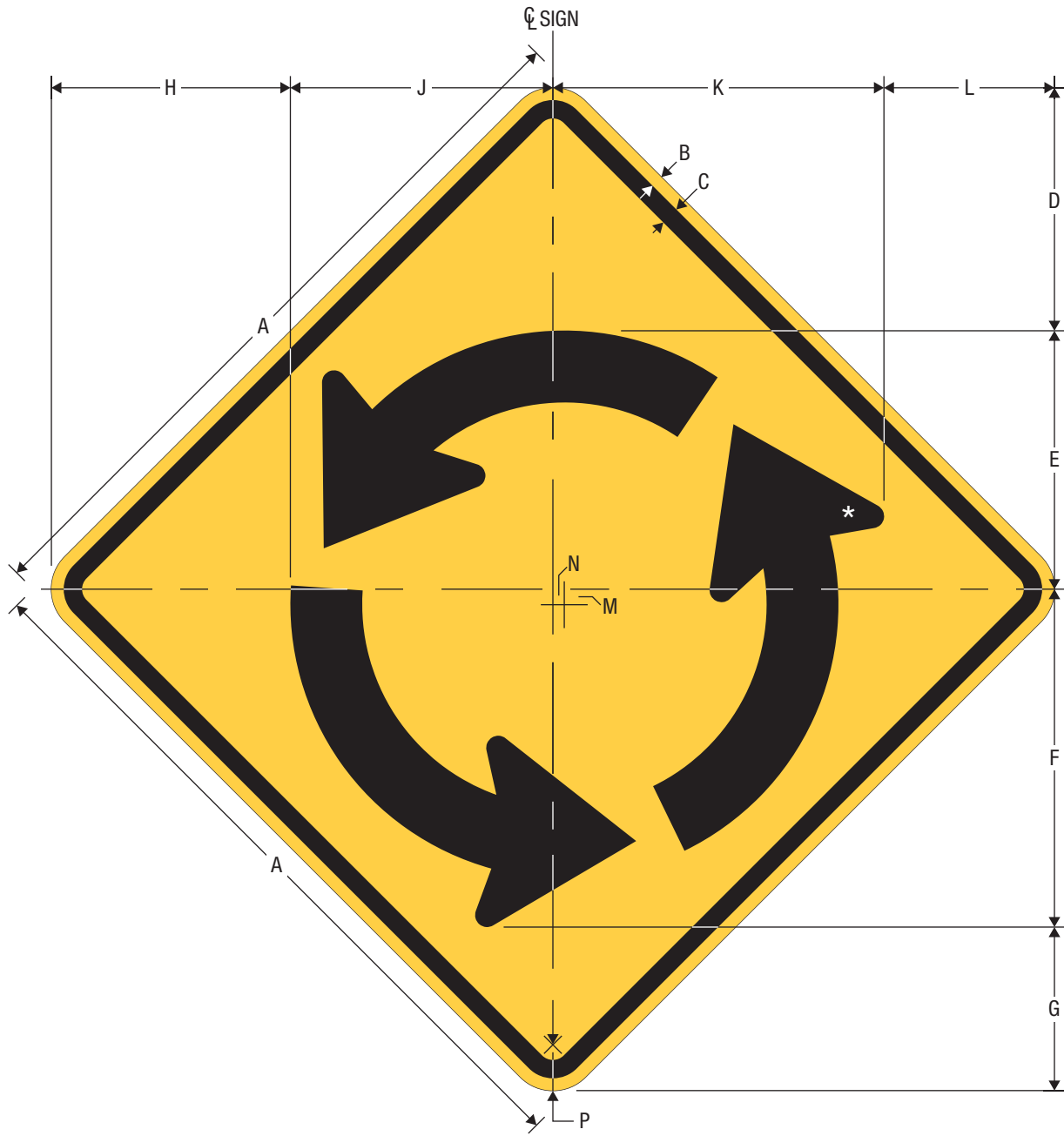

**W2-6**  
INTERSECTION WARNING - CIRCULAR

\* See page 8-50 for symbol design.

A	B	C	D	E	F	G	H	J	K	L	M	N	P
24	0.375	0.625	7.915	8.434	11.017	5.332	7.790	8.559	10.796	5.553	0.5	0.375	1.5
30	0.5	0.75	9.894	10.542	13.772	6.665	9.738	10.699	13.495	6.942	0.625	0.469	1.875
36	0.625	0.875	11.873	12.651	16.526	7.998	11.685	12.838	16.194	8.330	0.75	0.563	2.25
48	0.75	1.25	15.831	16.868	22.035	10.664	15.581	17.118	21.592	11.107	1	0.75	3

COLORS: LEGEND, BORDER – BLACK  
BACKGROUND – YELLOW (RETROREFLECTIVE)

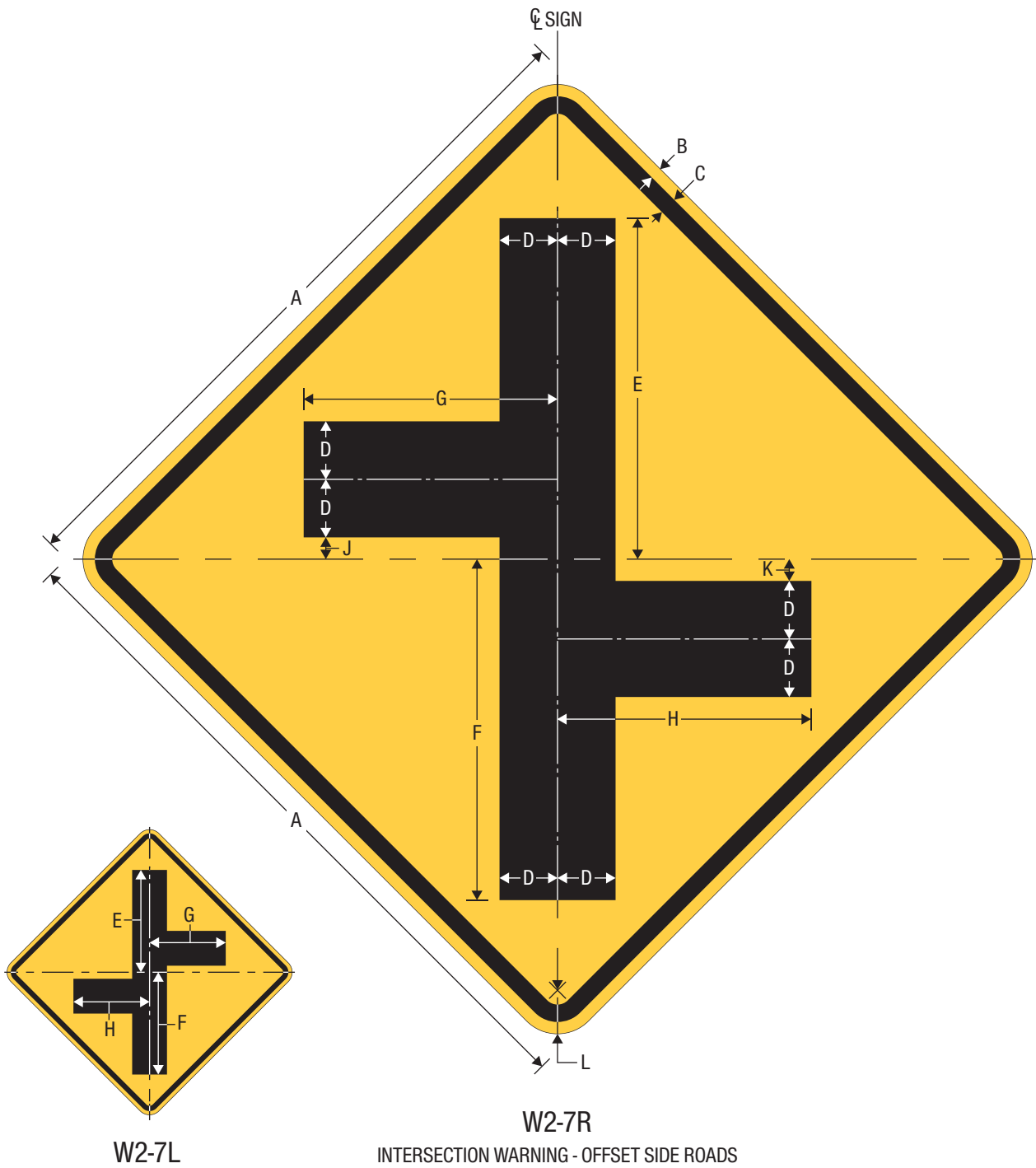

A	B	C	D	E	F	G	H	J	K	L
24	0.375	0.625	2	11.75	11.75	8.75	8.75	0.75	0.75	1.5
30	0.5	0.75	2.5	14.688	14.687	10.938	10.937	0.938	0.937	1.875
36	0.625	0.875	3	17.625	17.625	13.125	13.125	1.125	1.125	2.25
48	0.75	1.25	4	21.5	21.5	16	16	1.5	1.5	3

COLORS: LEGEND, BORDER – BLACK  
BACKGROUND – YELLOW (RETROREFLECTIVE)

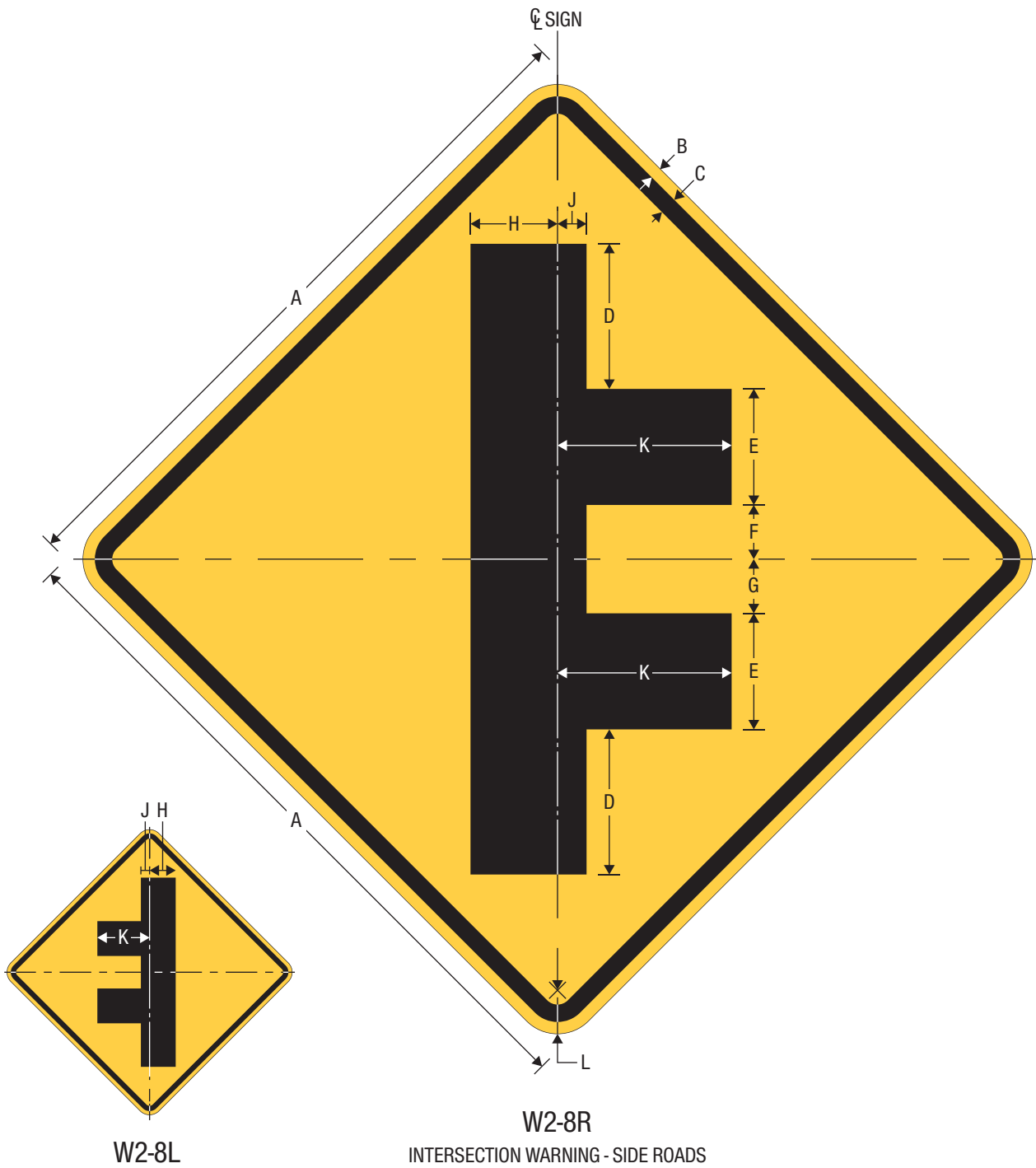

A	B	C	D	E	F	G	H	J	K	L
24	0.375	0.625	5	4	1.875	1.875	3	1	6	1.5
30	0.5	0.75	6.25	5	2.344	2.343	3.75	1.25	7.5	1.875
36	0.625	0.875	7.5	6	2.813	2.812	4.5	1.5	9	2.25
48	0.75	1.25	10	8	3.75	3.75	6	2	12	3

COLORS: LEGEND, BORDER – BLACK  
BACKGROUND – YELLOW (RETROREFLECTIVE)



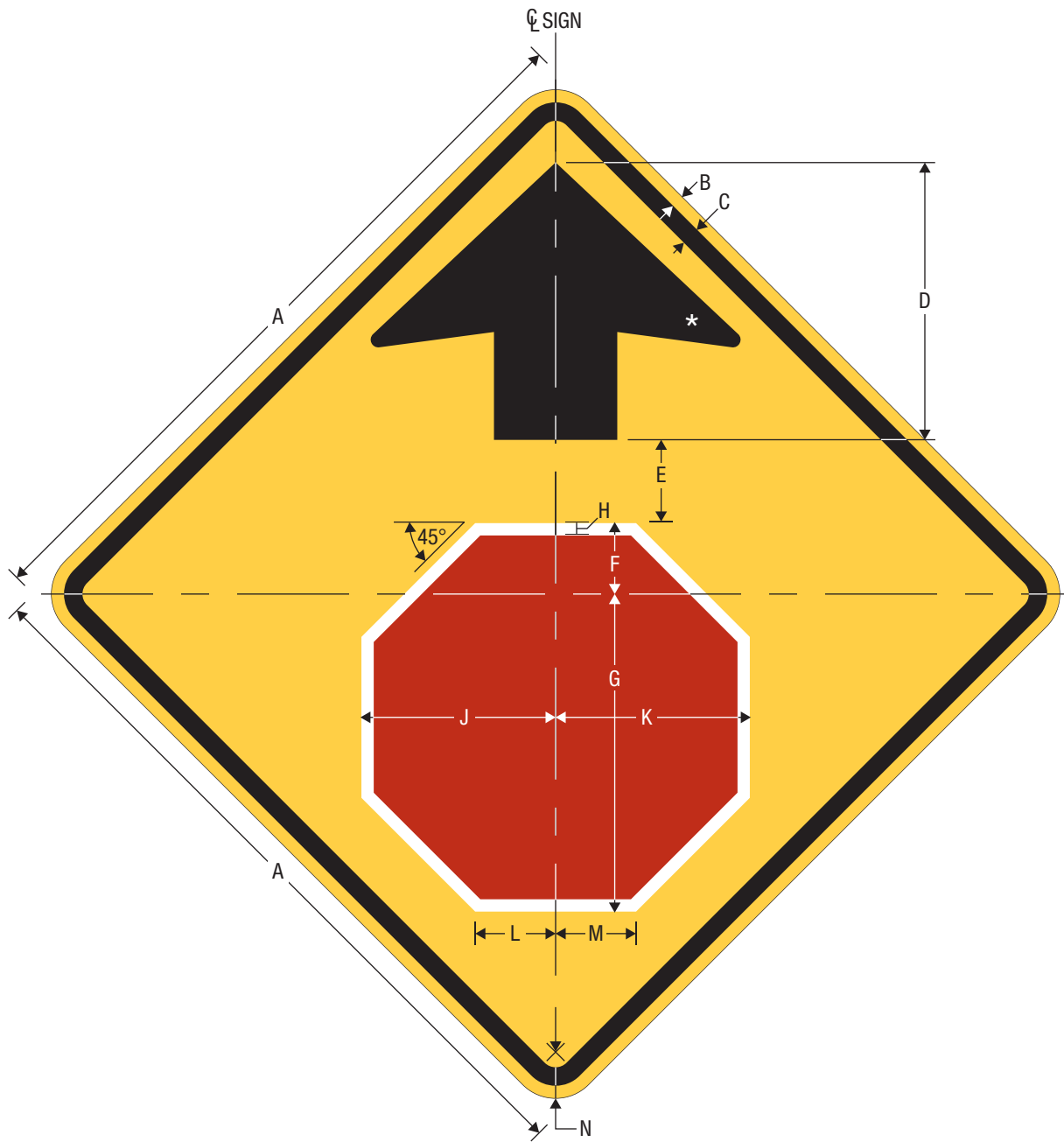

W3-1  
STOP AHEAD

\* See page 7-6 for arrow design.

A	B	C	D	E	F	G	H	J	K	L	M	N
18	0.375	0.625	6.75	2	1.75	7.75	0.313	4.75	4.75	1.968	1.967	1.5
30	0.5	0.75	11.25	3.375	2.875	12.875	0.5	7.875	7.875	3.262	3.262	1.875
36	0.625	0.875	13.5	4.125	3.375	15.625	0.625	9.5	9.5	3.935	3.935	2.25
48	0.75	1.25	18	5.5	4.5	20.625	0.75	12.563	12.562	5.204	5.203	3

WARNING SIGN

COLORS: ARROW, BORDER – BLACK  
 SYMBOL – RED (RETROREFLECTIVE)  
 SYMBOL BORDER – WHITE (RETROREFLECTIVE)  
 BACKGROUND – YELLOW (RETROREFLECTIVE)

TTC SIGN

COLORS: ARROW, BORDER – BLACK  
 SYMBOL – RED (RETROREFLECTIVE)  
 SYMBOL BORDER – WHITE (RETROREFLECTIVE)  
 BACKGROUND – ORANGE (RETROREFLECTIVE)

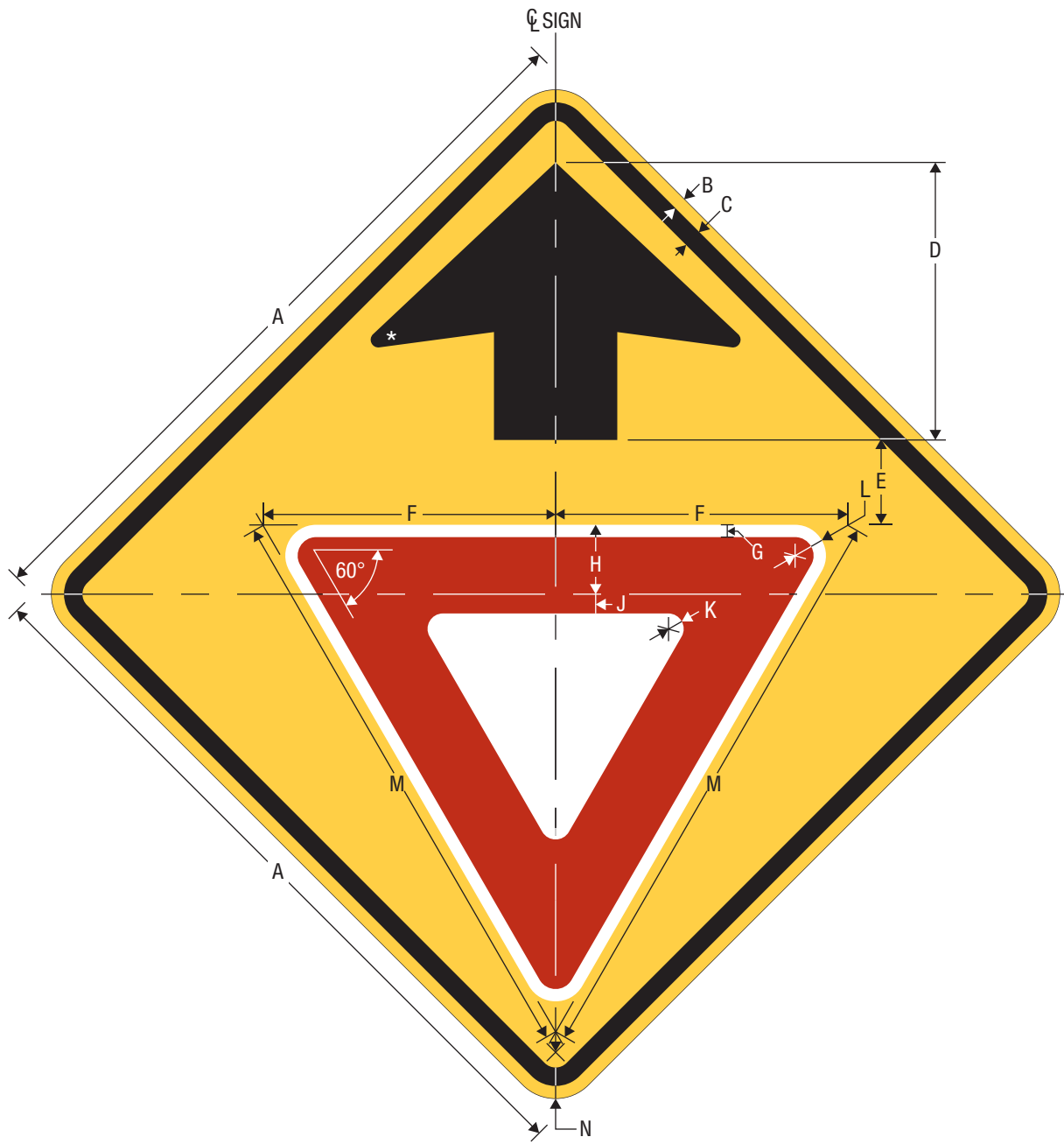

W3-2  
YIELD AHEAD

\* See page 7-6 for arrow design.

A	B	C	D	E	F	G	H	J	K	L	M	N
18	0.375	0.625	6.75	2.063	7.125	0.313	1.688	0.469	0.375	0.75	14.25	1.5
30	0.5	0.75	11.25	3.438	11.875	0.5	2.813	0.781	0.625	1.25	23.75	1.875
36	0.625	0.875	13.5	4.125	14.25	0.625	3.375	0.938	0.75	1.375	28.5	2.25
48	0.75	1.25	18	5.5	19	0.75	4.5	1.25	1	1.875	38	3

WARNING SIGN

COLORS: ARROW, BORDER – BLACK  
 SYMBOL – RED (RETROREFLECTIVE)  
 SYMBOL BORDER – WHITE (RETROREFLECTIVE)  
 BACKGROUND – YELLOW (RETROREFLECTIVE)

TTC SIGN

COLORS: ARROW, BORDER – BLACK  
 SYMBOL – RED (RETROREFLECTIVE)  
 SYMBOL BORDER – WHITE (RETROREFLECTIVE)  
 BACKGROUND – ORANGE (RETROREFLECTIVE)



**W3-5**  
REDUCED SPEED LIMIT AHEAD

\* See page 7-6 for arrow design.  
\*\* Optically space numerals about centerline.

A	B	C	D	E	F	G	H	J	K
30	0.5	0.75	10	2.5	0.5	1.625	2.5 E	0.875	10 C
36	0.625	0.875	12	3	1	2	3 E	1	12 C
48	0.75	1.25	16	4	1.5	2.25	4 E	1.25	15 C

L	M	N	P	Q	R	S	T	U	V
0.313	0.5	1.875	5.877	5.877	4.576	4.575	VAR**	7.5	1.875
0.375	0.625	2.25	7.053	7.052	5.491	5.491	VAR**	9	2.25
0.375	0.625	3	9.403	9.403	7.321	7.321	VAR**	12	3

**WARNING SIGN**

**COLORS:** LEGEND, ARROW, BORDER – BLACK  
INNER PANEL BACKGROUND – WHITE (RETROREFLECTIVE)  
BACKGROUND – YELLOW (RETROREFLECTIVE)

**TTC SIGN**

**COLORS:** LEGEND, ARROW, BORDER – BLACK  
INNER PANEL BACKGROUND – WHITE (RETROREFLECTIVE)  
BACKGROUND – ORANGE (RETROREFLECTIVE)

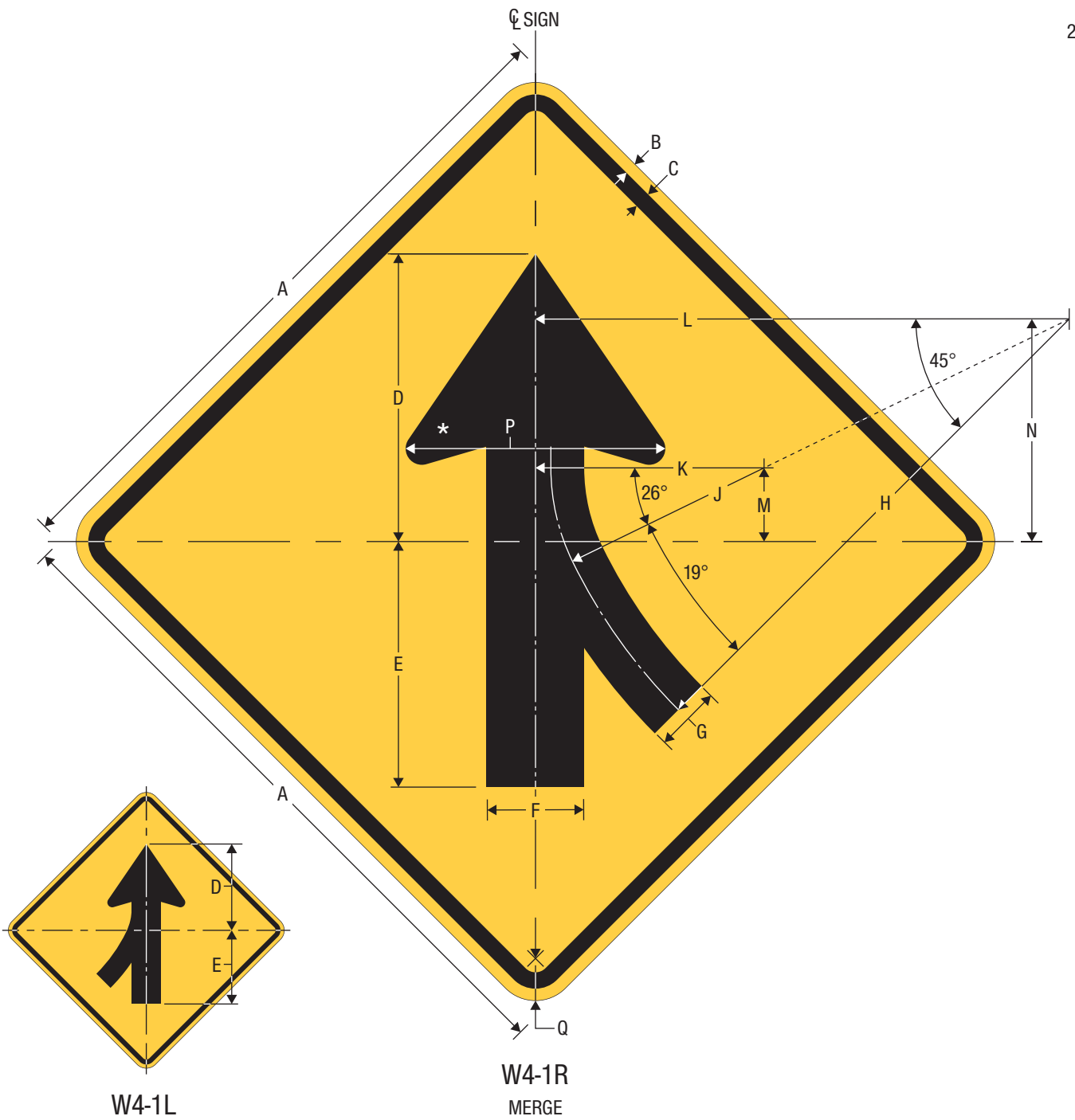

W4-1L

W4-1R  
MERGE

\* See page 7-3 for arrow design.

A	B	C	D	E	F	G	H
30	0.5	0.75	12.813	10.938	4.336	2.969	24.609
36	0.625	0.875	15.375	13.125	5.203	3.563	29.531
48	0.75	1.25	20.5	17.5	6.938	4.75	39.375

J	K	L	M	N	P	Q
9.492	10.176	23.763	3.281	9.908	11.563	1.875
11.391	12.211	28.516	3.938	11.890	13.875	2.25
15.188	16.281	38.021	5.25	15.853	18.5	3

WARNING SIGN  
 COLORS: LEGEND, BORDER — BLACK  
 BACKGROUND — YELLOW (RETROREFLECTIVE)

TTC SIGN  
 COLORS: LEGEND, BORDER — BLACK  
 BACKGROUND — ORANGE (RETROREFLECTIVE)

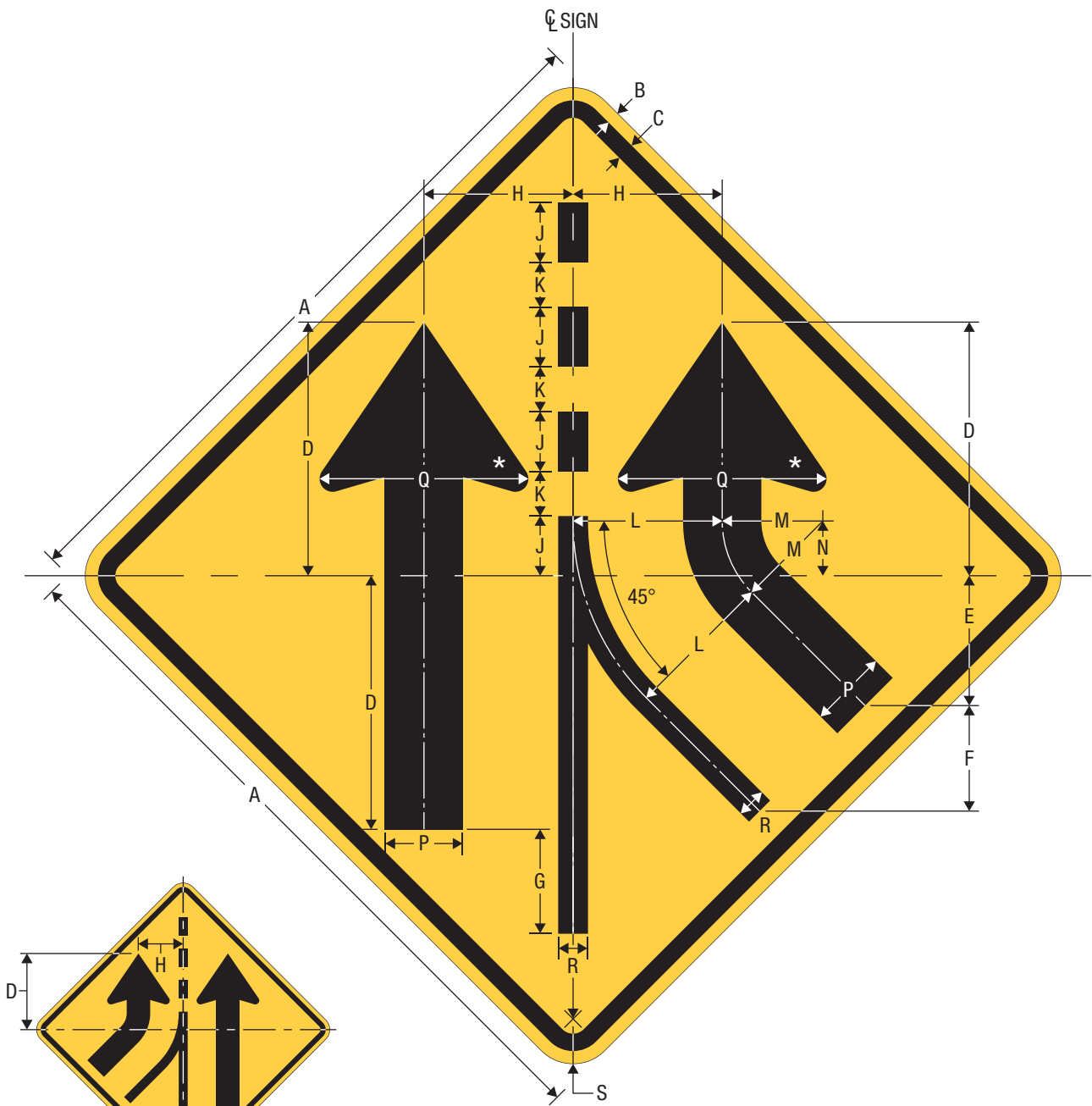

W4-3L

W4-3R  
ADDED LANE

\* See page 7-3 for arrow design.

A	B	C	D	E	F	G	H	J
30	0.5	0.75	10.625	5.442	4.419	4.375	6.25	2.5
36	0.625	0.875	12.75	6.530	5.303	5.25	7.5	3
48	0.75	1.25	17	8.707	7.071	7	10	4

K	L	M	N	P	Q	R	S
1.875	6.25	4.219	2.292	3.281	8.75	1.25	1.875
2.25	7.5	5.063	2.75	3.938	10.5	1.5	2.25
3	10	6.75	3.667	5.25	14	2	3

WARNING SIGN  
 COLORS: LEGEND, BORDER — BLACK  
 BACKGROUND — YELLOW (RETROREFLECTIVE)

TTC SIGN  
 COLORS: LEGEND, BORDER — BLACK  
 BACKGROUND — ORANGE (RETROREFLECTIVE)

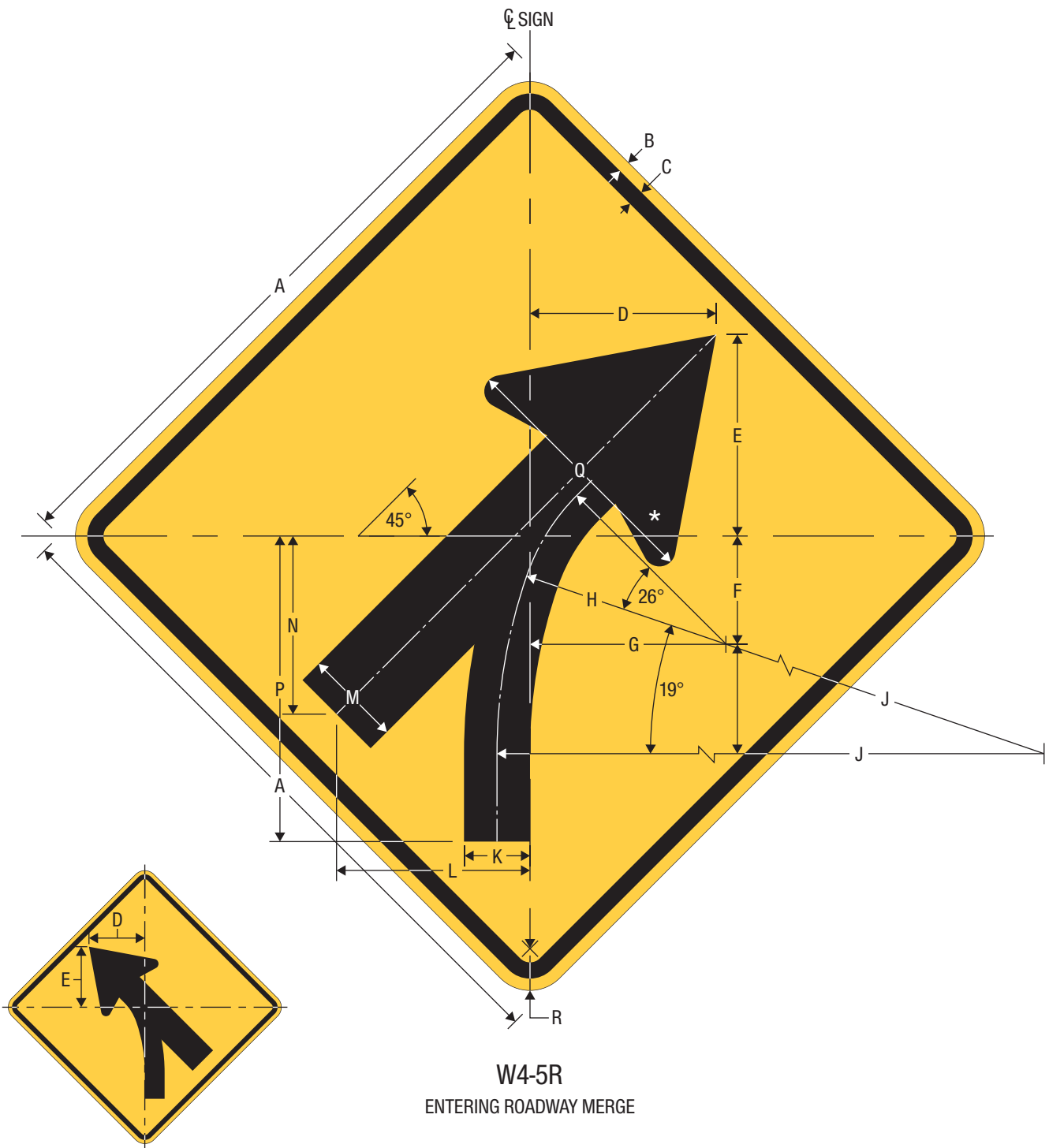

W4-5R  
ENTERING ROADWAY MERGE

W4-5L

\* See page 7-3 for arrow design.

A	B	C	D	E	F	G	H
36	0.625	0.875	10.051	10.875	5.847	10.598	11.391
48	0.75	1.25	13.401	14.5	7.796	14.130	15.188

J	K	L	M	N	P	Q	R
29.531	3.563	10.443	5.203	9.619	16.5	13.875	2.25
39.375	4.75	13.924	6.938	12.826	22	18.5	3

WARNING SIGN  
 COLORS: LEGEND, BORDER — BLACK  
 BACKGROUND — YELLOW (RETROREFLECTIVE)

TTC SIGN  
 COLORS: LEGEND, BORDER — BLACK  
 BACKGROUND — ORANGE (RETROREFLECTIVE)

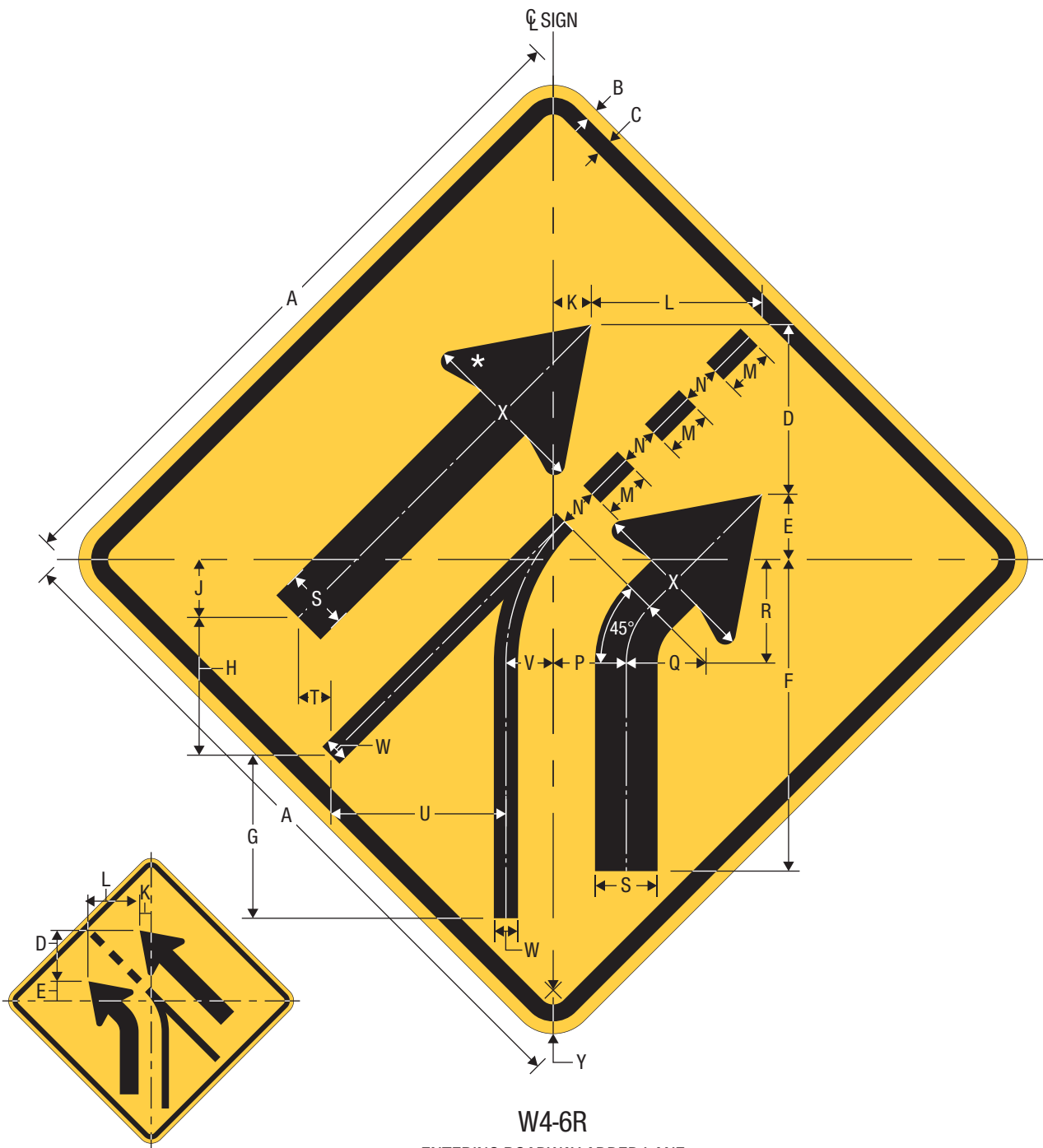

W4-6L

W4-6R  
ENTERING ROADWAY ADDED LANE

\* See page 7-3 for arrow design.

A	B	C	D	E	F	G	H	J	K	L	M
30	0.5	0.75	7.312	2.813	13.438	7.031	5.938	2.5	1.645	7.361	2.083
36	0.625	0.875	8.774	3.375	16.125	8.438	7.125	3	1.974	8.833	2.5
48	0.75	1.25	11.699	4.5	21.5	11.25	9.5	4	2.632	11.777	3.333

N	P	Q	R	S	T	U	V	W	X	Y
1.667	3.150	3.438	4.467	2.695	1.399	7.544	2.037	1.041	7.188	1.875
2	3.780	4.125	5.360	3.234	1.678	9.052	2.445	1.249	8.625	2.25
2.667	5.041	5.5	7.146	4.313	2.238	12.070	3.259	1.666	11.5	3

WARNING SIGN  
 COLORS: LEGEND, BORDER — BLACK  
 BACKGROUND — YELLOW (RETROREFLECTIVE)

TTC SIGN  
 COLORS: LEGEND, BORDER — BLACK  
 BACKGROUND — ORANGE (RETROREFLECTIVE)

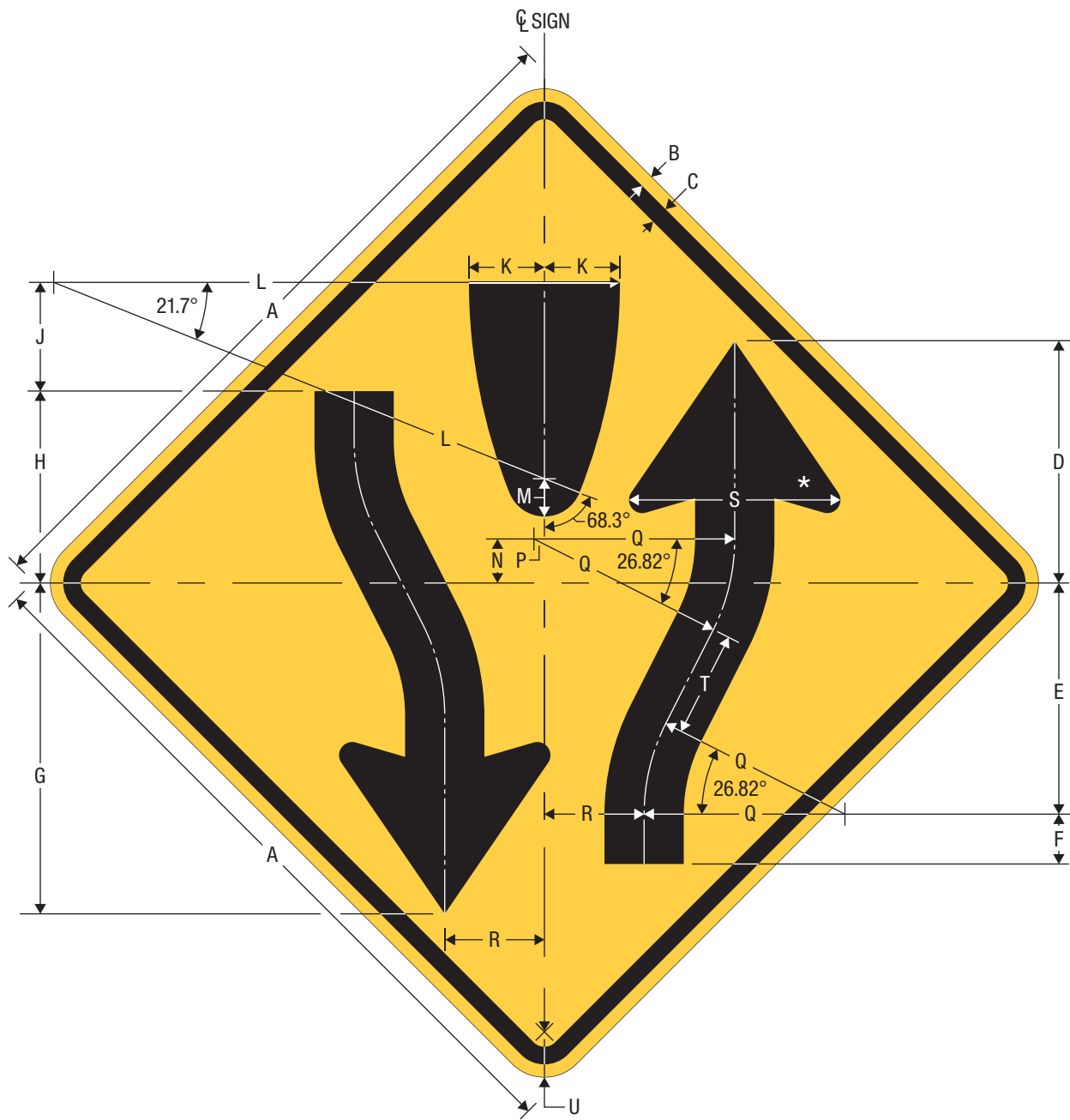

**W6-1**  
DIVIDED HIGHWAY

\* See page 7-3 for arrow design.

A	B	C	D	E	F	G	H	J	K
30	0.5	0.75	10	9.562	2.063	13.687	7.938	4.500	3.125
36	0.625	0.875	12	11.450	2.5	16.425	9.525	5.400	3.75
48	0.75	1.25	16	15.299	3.301	21.900	12.700	7.200	5

L	M	N	P	Q	R	S	T	U
23.438	1.563	1.818	0.438	8.313	4.125	8.75	4.346	1.875
28.125	1.875	2.182	0.525	9.975	4.950	10.5	5.215	2.25
37.5	2.5	2.909	0.700	13.300	6.600	14	6.953	3

WARNING SIGN  
 COLORS: LEGEND, BORDER — BLACK  
 BACKGROUND — YELLOW (RETROREFLECTIVE)

TTC SIGN  
 COLORS: LEGEND, BORDER — BLACK  
 BACKGROUND — ORANGE (RETROREFLECTIVE)



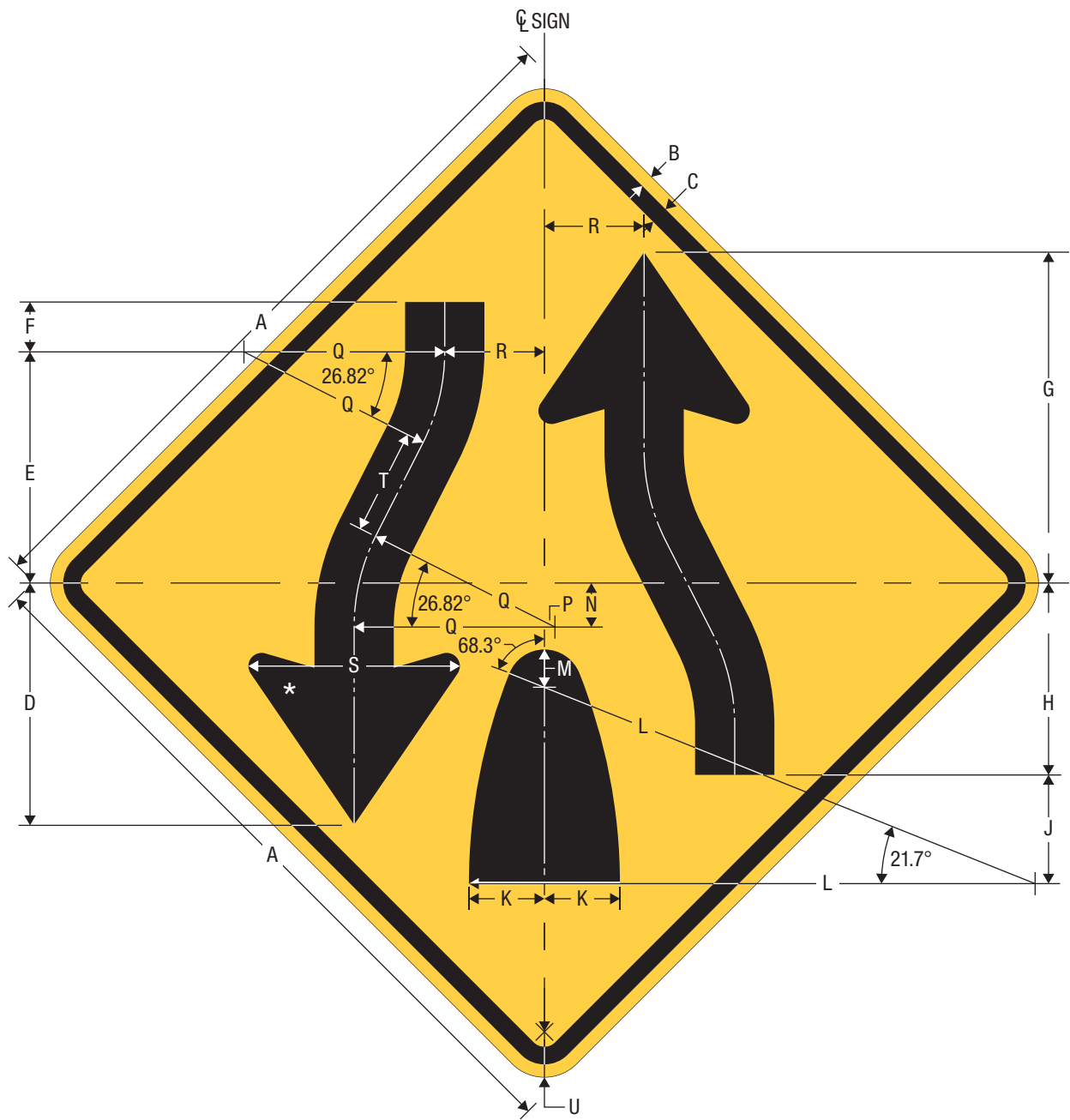

**W6-2**  
DIVIDED HIGHWAY ENDS

\* See page 7-3 for arrow design.

A	B	C	D	E	F	G	H	J	K
30	0.5	0.75	10	9.562	2.063	13.687	7.938	4.500	3.125
36	0.625	0.875	12	11.450	2.5	16.425	9.525	5.400	3.75
48	0.75	1.25	16	15.299	3.301	21.900	12.700	7.200	5

L	M	N	P	Q	R	S	T	U
23.438	1.563	1.818	0.438	8.313	4.125	8.75	4.346	1.875
28.125	1.875	2.182	0.525	9.975	4.950	10.5	5.215	2.25
37.5	2.5	2.909	0.700	13.300	6.600	14	6.953	3

WARNING SIGN  
 COLORS: LEGEND, BORDER — BLACK  
 BACKGROUND — YELLOW (RETROREFLECTIVE)

TTC SIGN  
 COLORS: LEGEND, BORDER — BLACK  
 BACKGROUND — ORANGE (RETROREFLECTIVE)

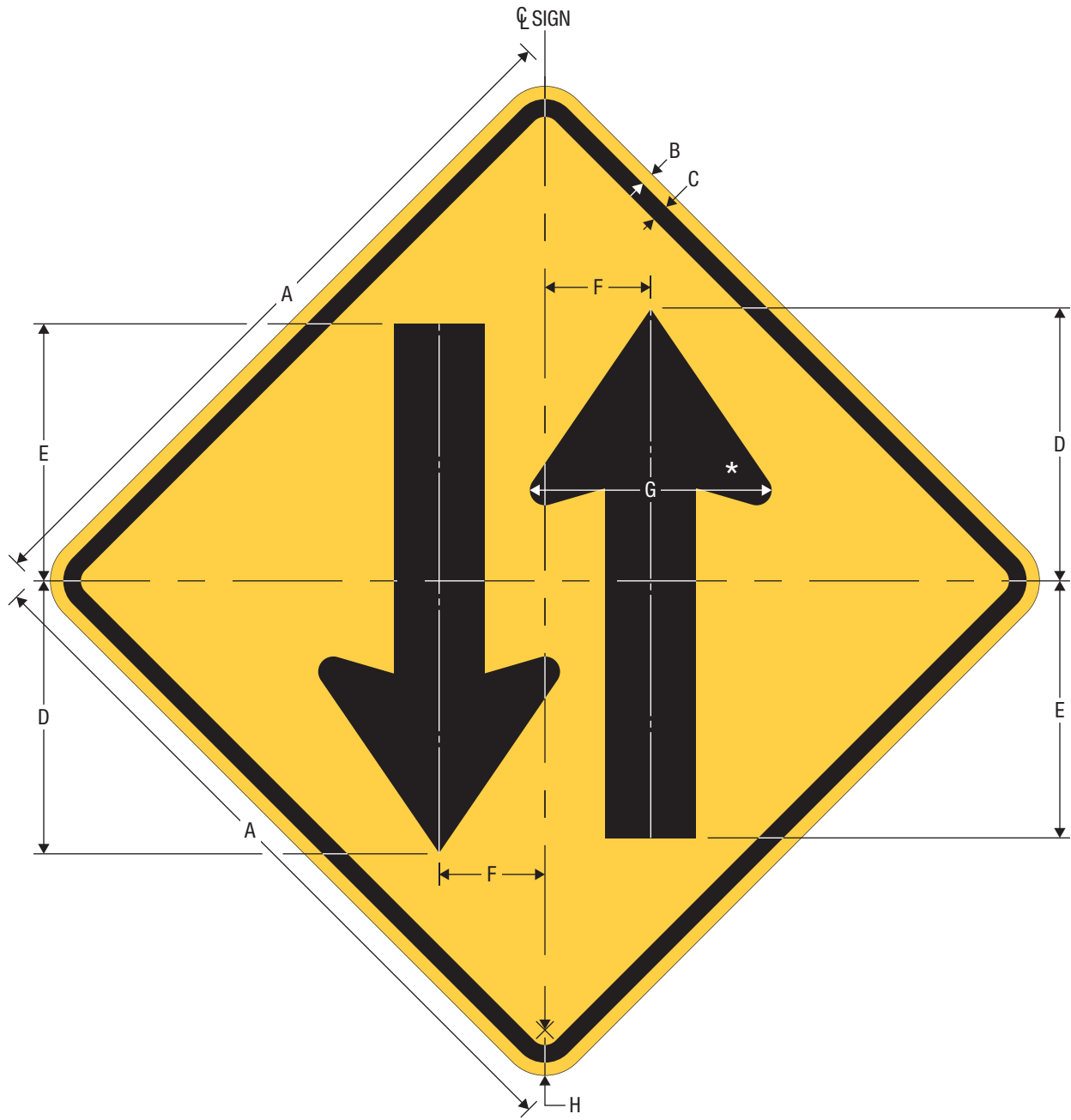

**W6-3**  
TWO-WAY TRAFFIC

\* See page 7-3 for arrow design.

A	B	C	D	E	F	G	H
30	0.5	0.75	11.25	10.625	4.375	10	1.875
36	0.625	0.875	13.5	12.75	5.25	12	2.25
48	0.75	1.25	18	17	7	16	3

WARNING SIGN  
 COLORS: LEGEND, BORDER — BLACK  
 BACKGROUND — YELLOW (RETROREFLECTIVE)

TTC SIGN  
 COLORS: LEGEND, BORDER — BLACK  
 BACKGROUND — ORANGE (RETROREFLECTIVE)

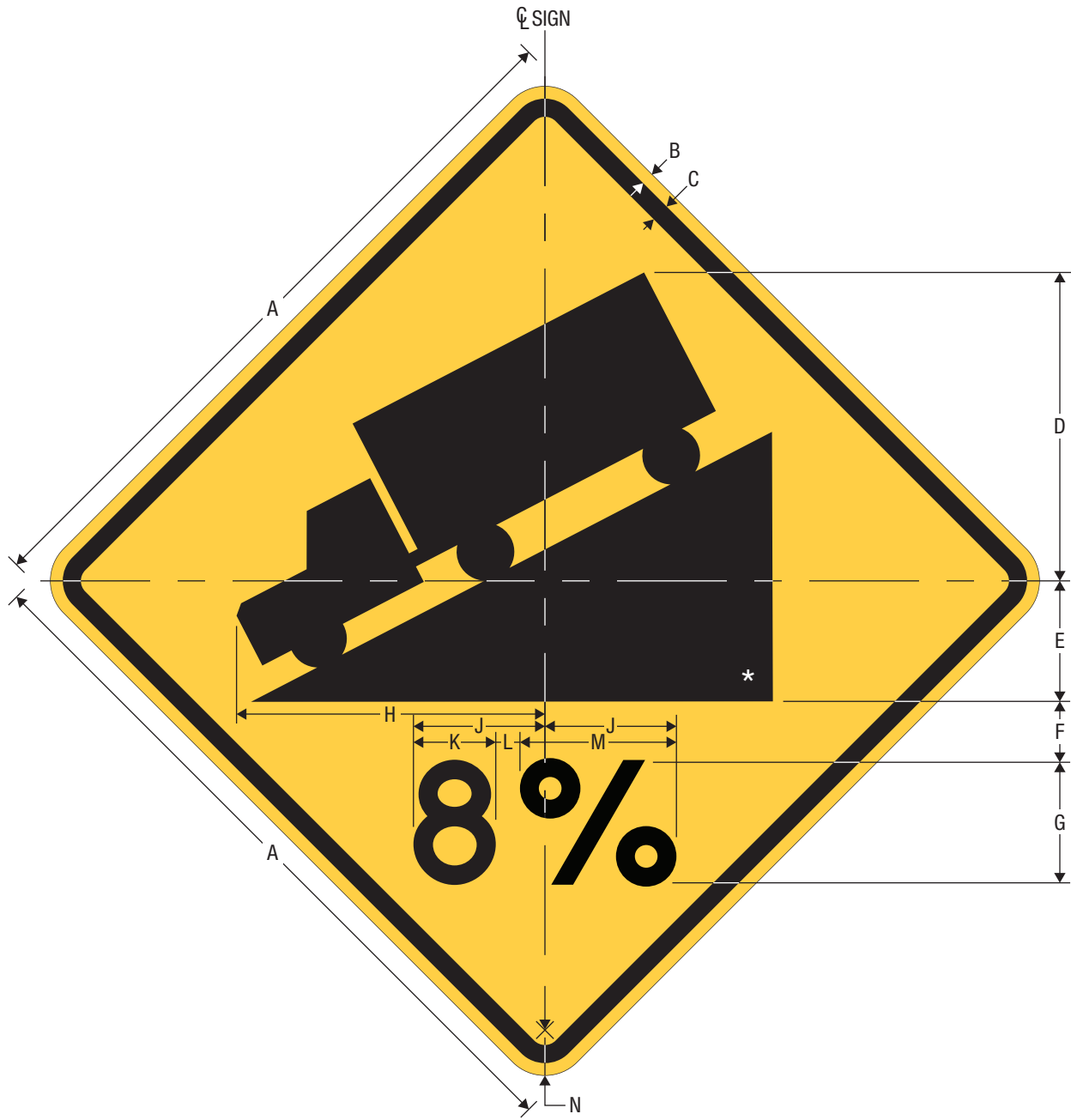

W7-1a  
HILL WITH GRADE

\* See page 8-28 for symbol design.

A	B	C	D	E	F	G	H	J	K	L	M	N
24	0.375	0.625	10	4	2	4 D	10.25	VAR	VAR	0.800	5.175	1.5
30	0.5	0.75	12.75	5	2.5	5 D	12.75	VAR	VAR	1	6.469	1.875
36	0.625	0.875	15.375	6	3	6 D	15.375	VAR	VAR	1.200	7.763	2.25
48	0.75	1.25	20	8	4	8 D	20.5	VAR	VAR	1.600	10.350	3

COLORS: LEGEND, BORDER – BLACK  
BACKGROUND – YELLOW (RETROREFLECTIVE)

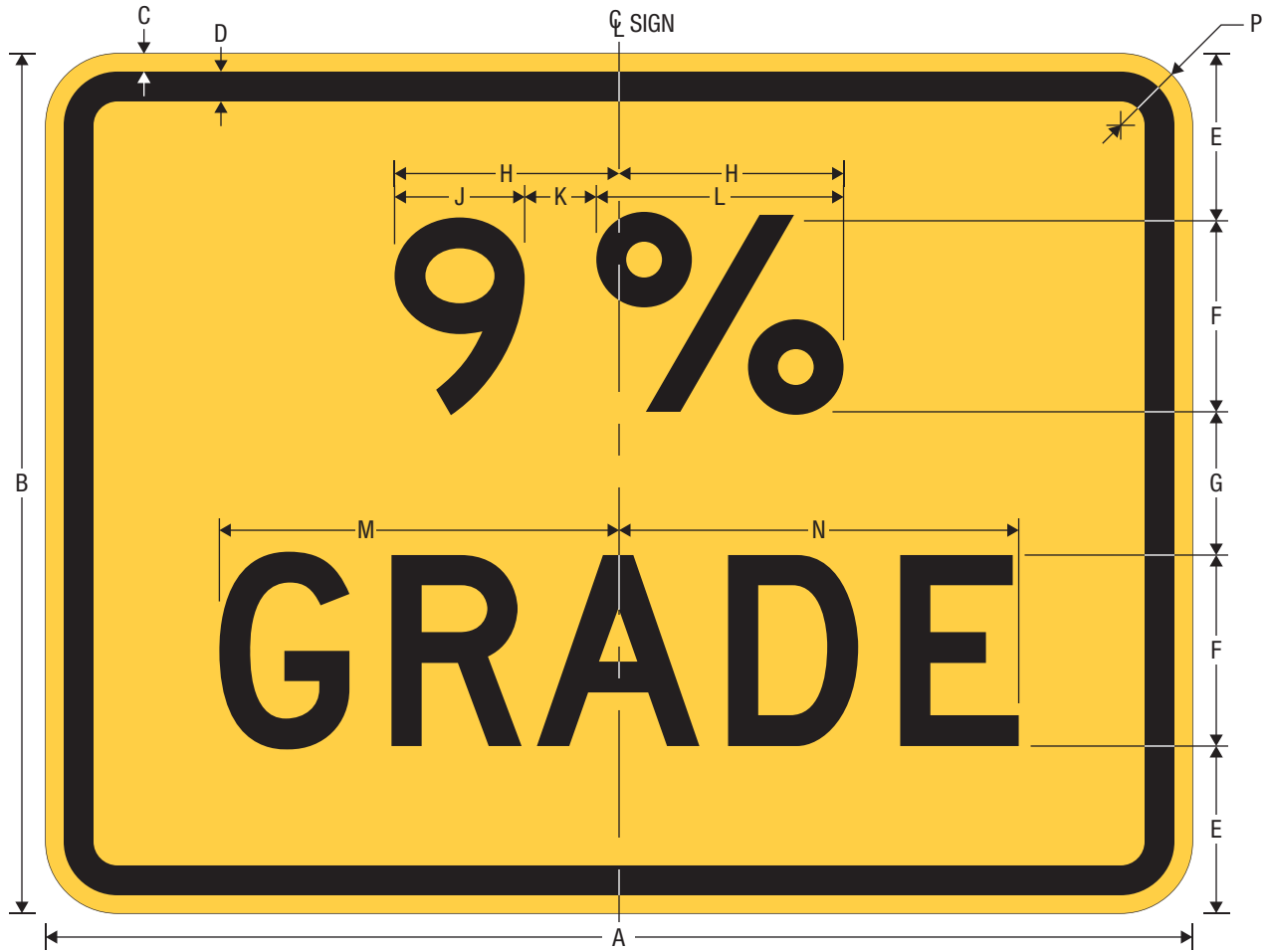

W7-3P  
XX% GRADE (PLAQUE)

A	B	C	D	E	F	G	H	J	K	L	M	N	P
24	18	0.375	0.625	3.5	4 D	3	VAR	VAR	1.5	5.175	8.366	8.366	1.5
30	24	0.375	0.625	5	5 D	4	VAR	VAR	1.875	6.469	10.458	10.457	1.5

COLORS: LEGEND, BORDER – BLACK  
BACKGROUND – YELLOW (RETROREFLECTIVE)

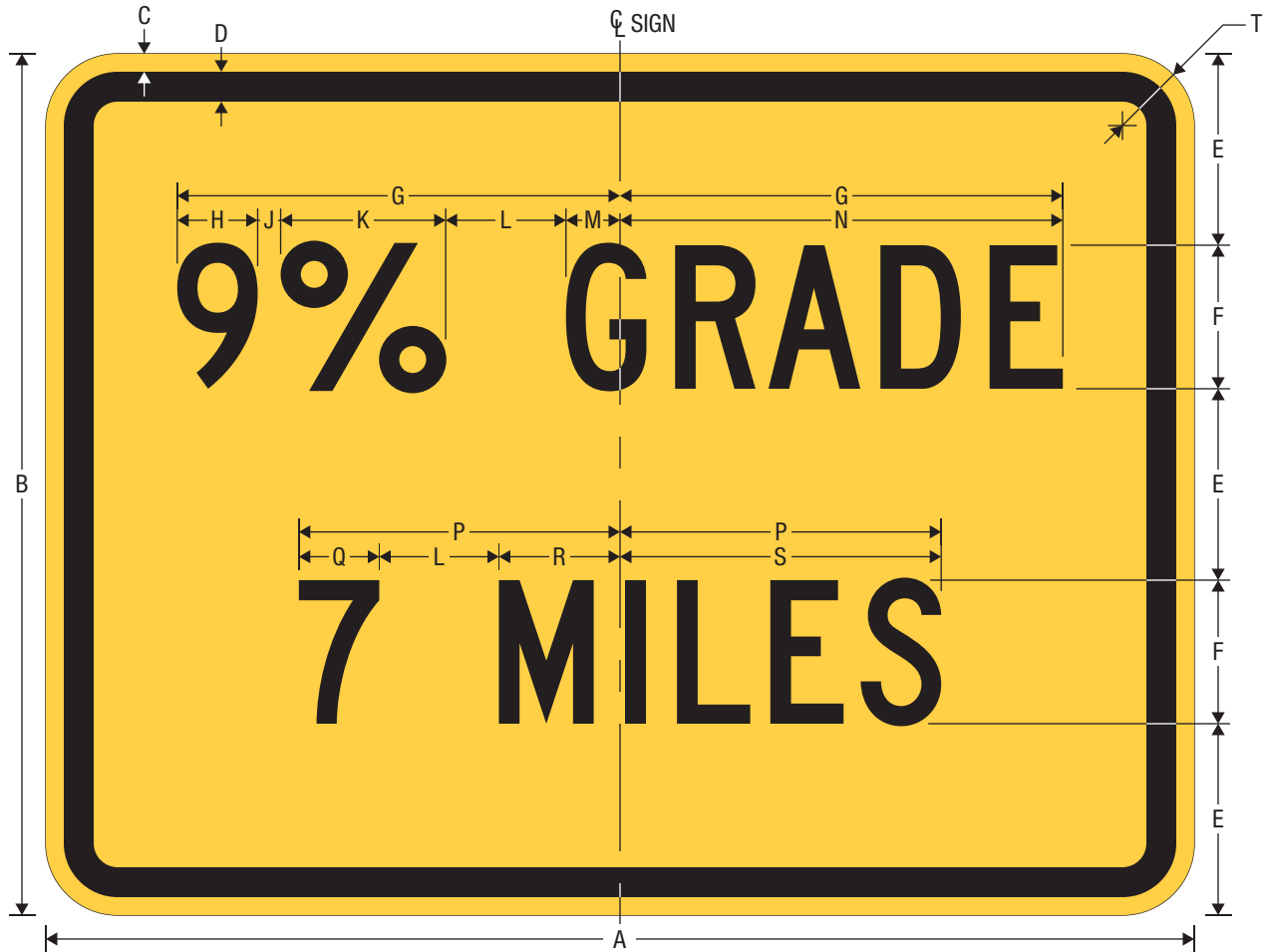

W7-3bP

XX% GRADE XX MILES (PLAQUE)

A	B	C	D	E	F	G	H	J
24	18	0.375	0.625	4	3 C	VAR	VAR	0.480

K	L	M	N	P	Q	R	S	T
3.463	2.5	1.130	9.254	VAR	VAR	2.532	6.712	1.5

COLORS: LEGEND, BORDER – BLACK  
BACKGROUND – YELLOW (RETROREFLECTIVE)



W12-2  
LOW CLEARANCE ADVANCE

\* See page 7-6 for arrow design.

A	B	C	D	E	F	G	H	J
18	0.375	0.625	6.75	0.975	3	6 C	VAR	VAR
30	0.5	0.75	11.25	1.625	5	10 C	VAR	VAR
36	0.625	0.875	13.5	1.950	6	12 C	VAR	VAR
48	0.75	1.25	18	2.600	8	16 C	VAR	VAR

K	L	M	N	P	Q	R	S
0.375	0.844	0.438	2	0.5	VAR	2.381	1.5
0.625	1.406	0.729	3.333	0.833	VAR	3.969	1.875
0.75	1.687	0.875	4	1	VAR	4.762	2.25
1	2.25	1.667	5.333	1.333	VAR	6.350	3

WARNING SIGN  
 COLORS: LEGEND, BORDER – BLACK  
 BACKGROUND – YELLOW (RETROREFLECTIVE)

TTC SIGN  
 COLORS: LEGEND, BORDER – BLACK  
 BACKGROUND – ORANGE (RETROREFLECTIVE)

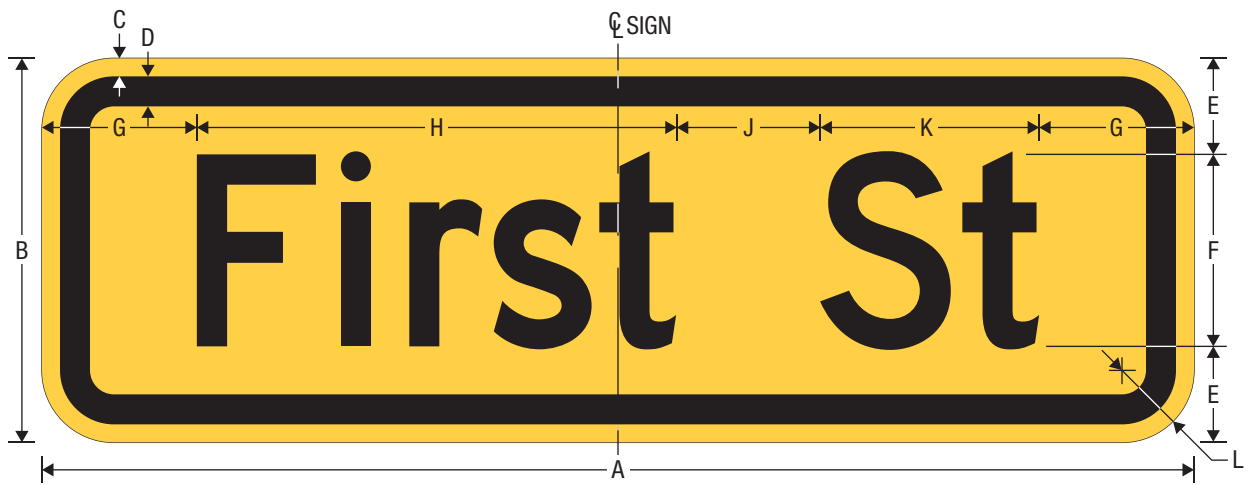

W16-8P

ADVANCE STREET NAME (1-LINE PLAQUE)

A	B	C	D	E	F	G	H	J	K	L
VAR	8	0.375	0.625	2	4 D	2.5 MIN	VAR	3	VAR	1.5

COLORS: LEGEND, BORDER — BLACK  
BACKGROUND — YELLOW (RETROREFLECTIVE)

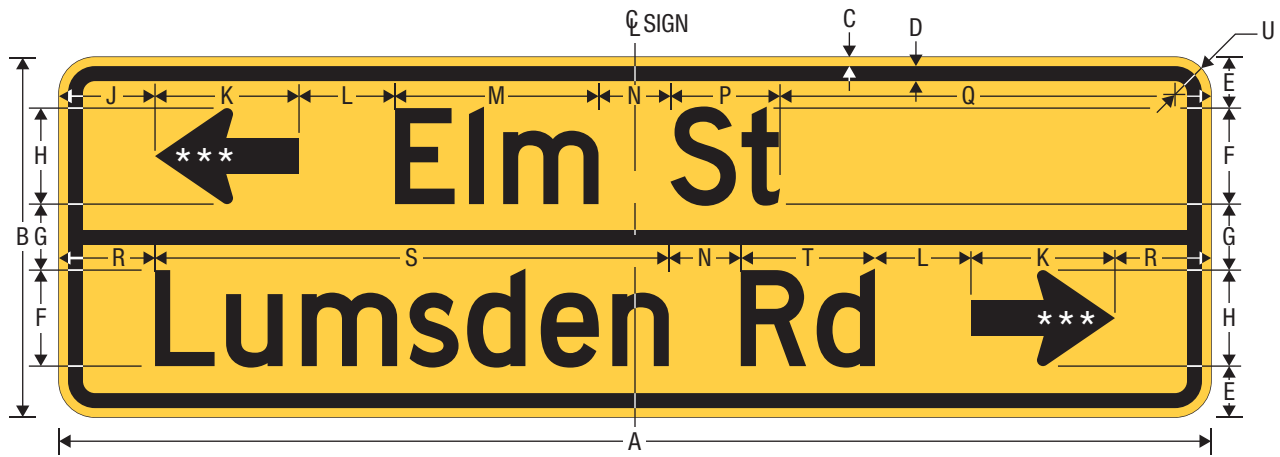

W16-8aP

ADVANCE STREET NAME (2-LINE PLAQUE)

- \* Controlling line of legend.
- \*\* Optically space non-controlling line.
- \*\*\* See page 7-3 for arrow design.

A	B	C	D	E	F	G	H	J	K
VAR	15	0.375	0.625	2.125	4 D	2.75	4	4 MIN**	6

L	M	N	P	Q	R	S	T	U
4 MIN, 6 MAX	VAR	3	VAR	4 MIN**	4 MIN*	VAR	VAR	1.5

COLORS: LEGEND, BORDER — BLACK  
BACKGROUND — YELLOW (RETROREFLECTIVE)



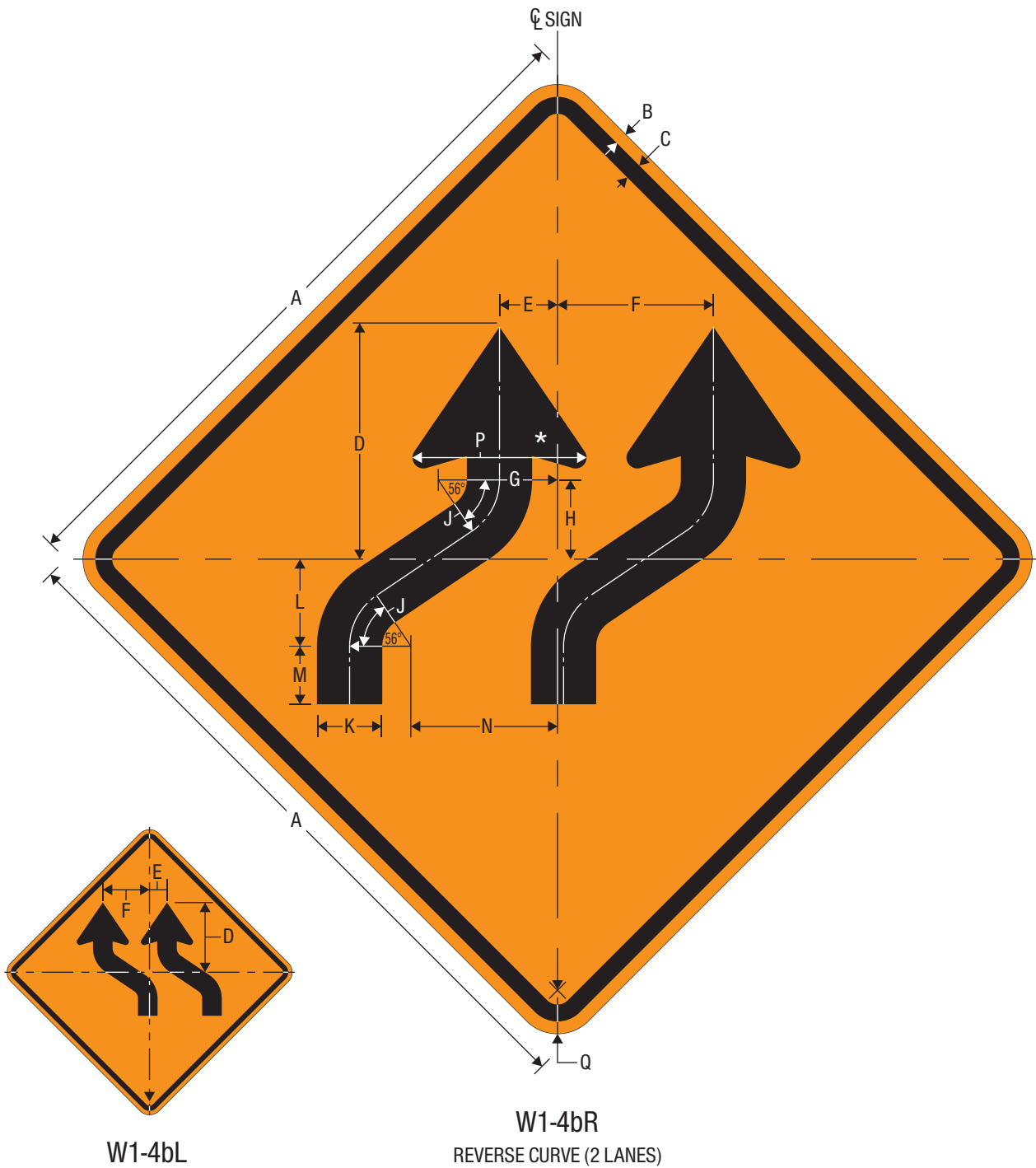

\* See page 7-3 for arrow design.

A	B	C	D	E	F	G	H	J	K	L	M	N	P	Q
30	0.5	0.75	10	2.5	6.719	5.139	3.412	2.639	2.813	3.75	2.5	6.319	7.5	1.875
36	0.625	0.875	12	3	8.063	6.167	4.095	3.167	3.375	4.5	3	7.583	9	2.25
48	0.75	1.25	16	4	10.75	8.222	5.460	4.222	4.5	6	4	10.111	12	3

COLORS: LEGEND, BORDER – BLACK  
BACKGROUND – ORANGE (RETROREFLECTIVE)

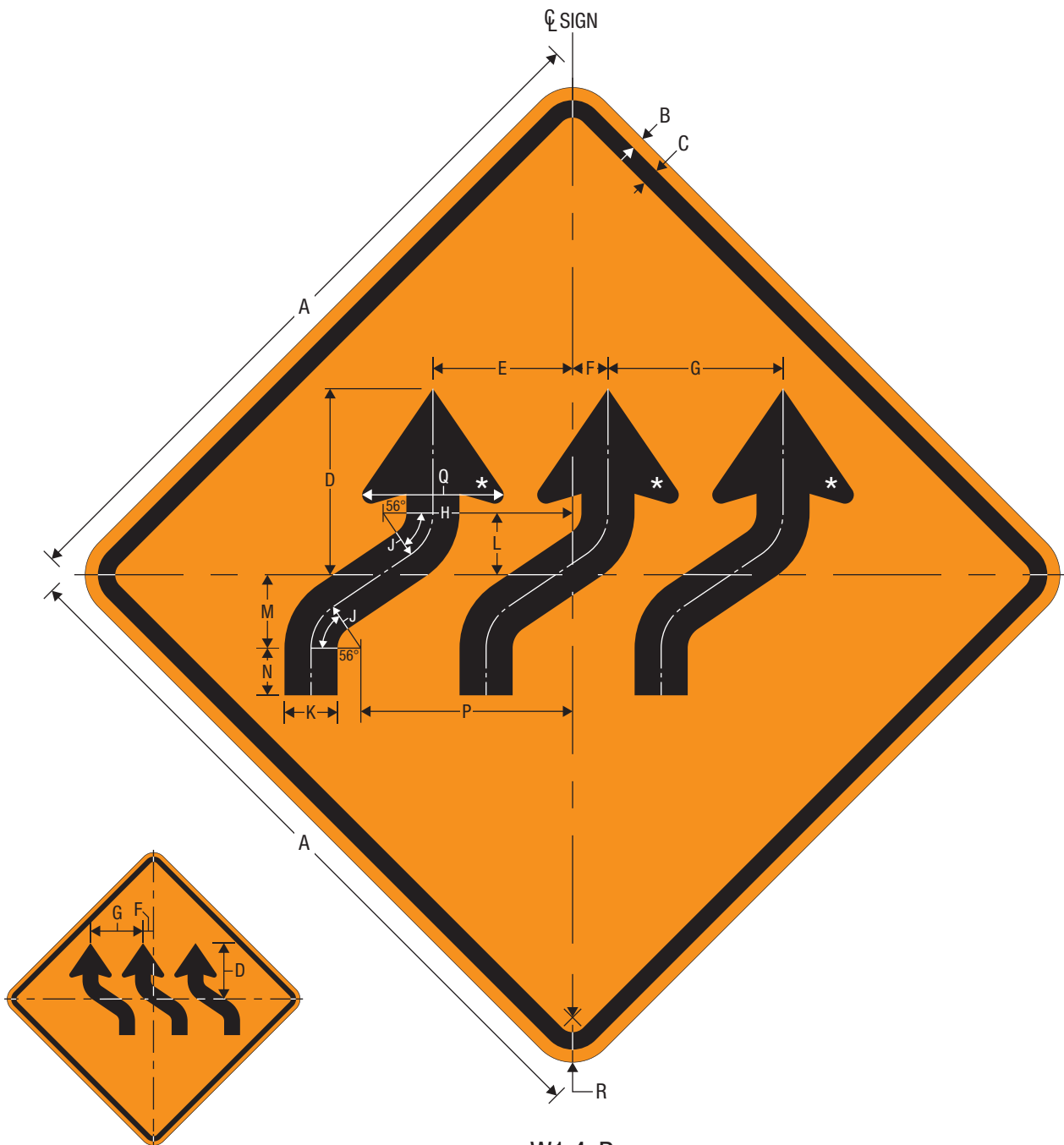

W1-4cL

W1-4cR  
REVERSE CURVE (3 LANES)

\* See page 7-3 for arrow design.

A	B	C	D	E	F	G	H
30	0.5	0.75	7.813	5.859	1.484	7.344	7.948
36	0.625	0.875	9.375	7.031	1.781	8.813	9.538
48	0.75	1.25	12.5	9.375	2.375	11.75	12.718

J	K	L	M	N	P	Q	R
2.089	2.227	2.597	3.073	1.979	8.883	5.938	1.875
2.507	2.672	3.117	3.688	2.375	10.660	7.125	2.25
3.343	3.563	4.156	4.917	3.167	14.213	9.5	3

COLORS: LEGEND, BORDER — BLACK  
BACKGROUND — ORANGE (RETROREFLECTIVE)

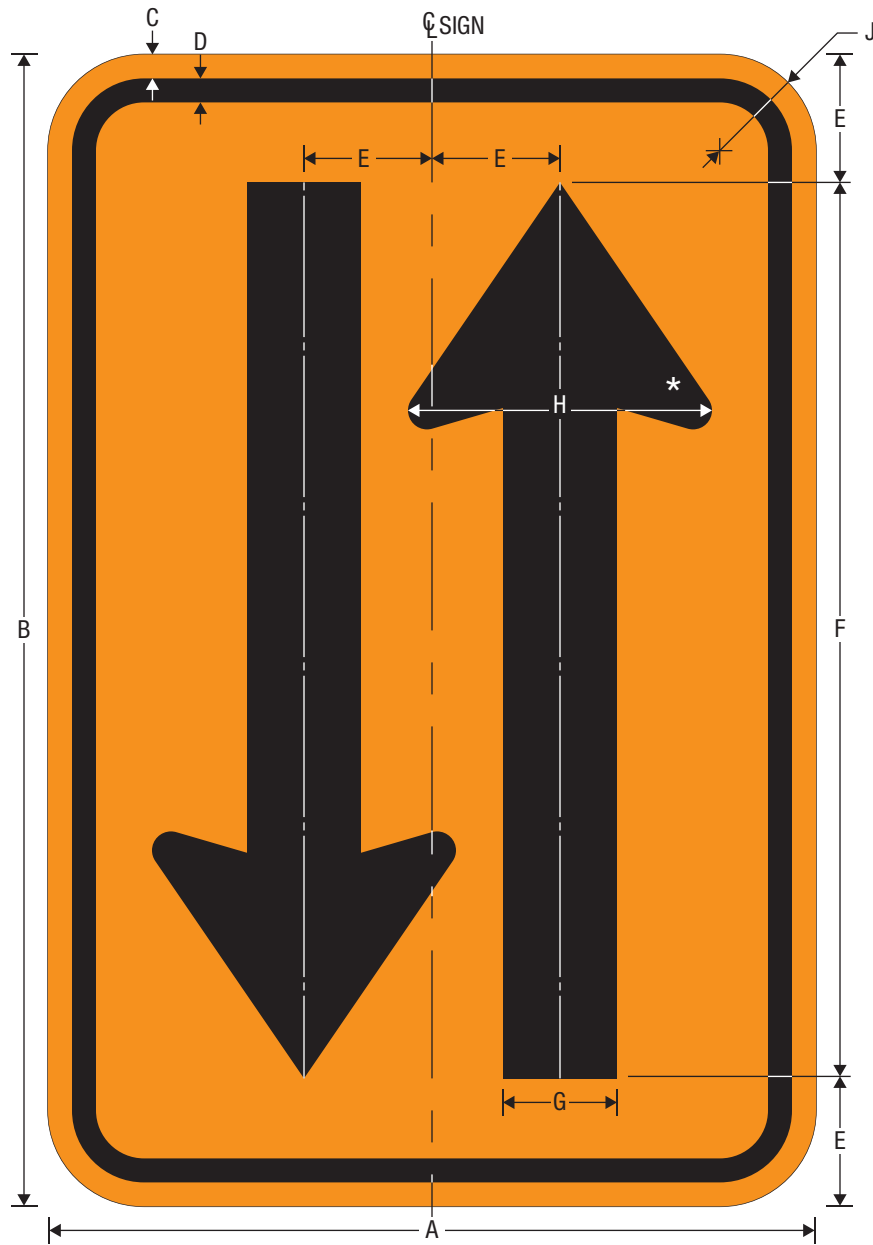

**W6-4**  
NARROW TWO-WAY TRAFFIC

\* See page 7-3 for arrow design.

A	B	C	D	E	F	G	H	J
12	18	0.375	0.375	2	14	1.781	4.75	1.5

COLORS: LEGEND, BORDER — BLACK  
BACKGROUND — ORANGE (RETROREFLECTIVE)

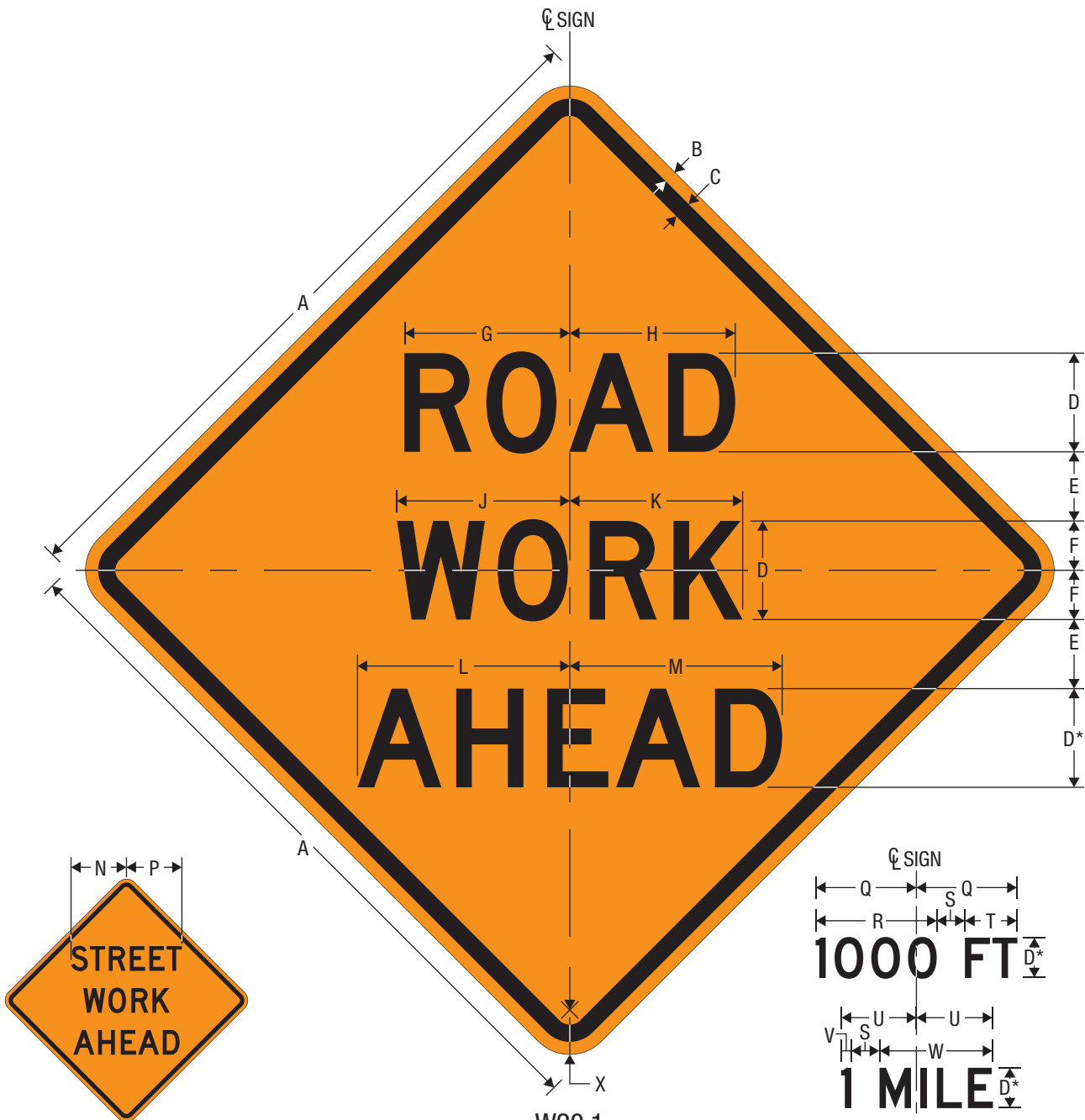

W20-1  
STREET WORK

W20-1  
ROAD WORK

\* The distance legend may be either AHEAD, XX FT, OR XX MILE(S) and Series C may be substituted where spacing limitations occur due to length of word message.

\*\* Reduce Spacing 30%.

A	B	C	D	E	F	G	H	J	K	L
30	0.5	0.75	4 D	2.75	2	6.705	6.705	7.005	7.004	8.606
36	0.625	0.875	5 D	3.5	2.5	8.382	8.381	8.756	8.755	10.757
48	0.75	1.25	7 D	4.75	3.5	11.734	11.734	12.258	12.258	15.060

M	N	P	Q	R	S	T	U	V	W	X
8.605	8.985	8.985	VAR	VAR	2.75	5.202	VAR	VAR	VAR	1.875
10.757	11.232	11.231	VAR	VAR	3.5	6.503	VAR	VAR	VAR	2.25
15.059	15.042**	15.041**	VAR	VAR	4	8.894	VAR	VAR	VAR	3

COLORS: LEGEND, BORDER — BLACK  
BACKGROUND — ORANGE (RETROREFLECTIVE)

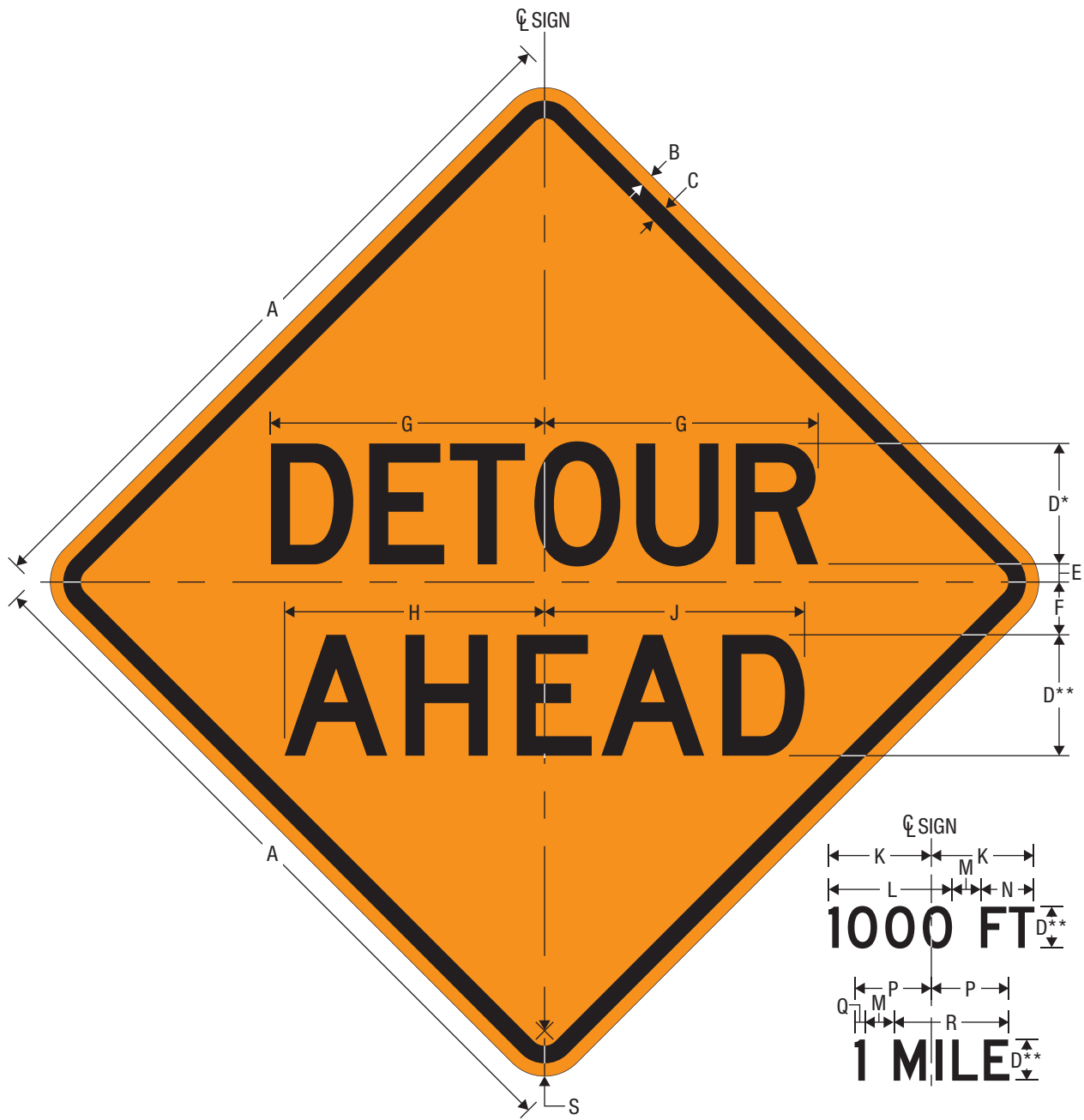

W20-2  
DETOUR

- \* Reduce Spacing 40%.
- \*\* The distance legend may be either AHEAD, XX FT, OR XX MILE(S) and Series C may be substituted where spacing limitations occur due to length of word message.

A	B	C	D	E	F	G	H	J
30	0.5	0.75	5 D	0.75	2.25	11.318	10.757	10.756
36	0.625	0.875	6 D	0.875	2.625	13.582	12.909	12.908
48	0.75	1.25	8 D	1.25	3.5	18.109	17.211	17.211

K	L	M	N	P	Q	R	S
VAR	VAR	3.5	6.383	VAR	VAR	VAR	1.875
VAR	VAR	4	7.659	VAR	VAR	VAR	2.25
VAR	VAR	5.5	10.212	VAR	VAR	VAR	3

COLORS: LEGEND, BORDER — BLACK  
BACKGROUND — ORANGE (RETROREFLECTIVE)



W20-3  
STREET CLOSED

W20-3  
ROAD CLOSED

\* The distance legend may be either AHEAD, XX FT, OR XX MILE(S) and Series C may be substituted where spacing limitations occur due to length of word message.  
\*\* Reduce Spacing 30%. \*\*\* Reduce Spacing 70%.

A	B	C	D	E	F	G	H	J	K	L	M
30	0.5	0.75	4 D	3	2.75	1.25	6.705	6.705	9.667	9.666	8.606
36	0.625	0.875	5 D	3.5	3.25	1.75	8.382	8.381	12.083	12.083	10.757
48	0.75	1.25	7 D	4.75	4.5	2.5	11.734	11.734	16.917	16.916	15.060

N	P	Q	R	S	T	U	V	W	X	Y
8.605	8.595**	8.595**	VAR	VAR	2.75	5.202	VAR	VAR	VAR	1.875
10.757	10.744**	10.744**	VAR	VAR	3.5	6.503	VAR	VAR	VAR	2.25
15.059	14.132***	14.131***	VAR	VAR	4	8.894	VAR	VAR	VAR	3

COLORS: LEGEND, BORDER — BLACK  
BACKGROUND — ORANGE (RETROREFLECTIVE)



**W20-4**  
ONE LANE ROAD  
(WITH DISTANCE)

- \* Reduce Spacing 30%.
- \*\* The distance legend may be either AHEAD, XX FT, OR XX MILE(S) and Series C may be substituted where spacing limitations occur due to length of word message.

A	B	C	D	E	F	G	H	J	K	L	M	N
30	0.5	0.75	4 C	1.875	1	3	4 C	8.323	2.621	0.379	10.564	5.522
36	0.625	0.875	5 C	2.25	1.25	3.75	5 C	10.404	3.276	0.474	13.205	6.903
48	0.75	1.25	7 C*	3.125	1.75	5.25	7 C	13.683	4.461	0.539	17.605	9.664

P	Q	R	S	T	U	V	W	X	Y	Z	AA
5.522	7.003	7.002	VAR	VAR	3	4.322	VAR	VAR	2.5	VAR	1.875
6.902	8.753	8.753	VAR	VAR	3.75	5.403	VAR	VAR	3.125	VAR	2.25
9.663	12.255	12.254	VAR	VAR	5	7.438*	VAR	VAR	4	VAR	3

COLORS: LEGEND, BORDER — BLACK  
BACKGROUND — ORANGE (RETROREFLECTIVE)



**W20-5L**  
LEFT LANE CLOSED (WITH DISTANCE)

**W20-5R**  
RIGHT LANE CLOSED (WITH DISTANCE)

\* The distance legend may be either AHEAD, XX FT, OR XX MILE(S) and Series C may be substituted where spacing limitations occur due to length of word message.

\*\* Reduce Spacing 30%.

A	B	C	D	E	F	G	H	J	K	L	M	N
30	0.5	0.75	4 C	1.625	12.164	0.700	2.300	10.564	8.203	8.203	7.003	7.002
36	0.625	0.875	5 C	2.5	14.140**	0.75	2.25	12.575**	10.254	10.254	8.753	8.753
48	0.75	1.25	6 C	3.5	18.246	1.050	3.450	15.846	12.305	12.304	10.504	10.504

P	Q	R	S	T	U	V	W	X	Y	Z	AA
9.644	1.960	1.040	10.564	VAR	VAR	2.75	4.322	VAR	VAR	VAR	1.875
12.055	2.075	0.925	13.205	VAR	VAR**	3	5.313**	VAR	VAR	VAR	2.25
14.466	2.940	1.560	15.846	VAR	VAR	4.5	6.483	VAR	VAR	VAR	3

COLORS: LEGEND, BORDER — BLACK  
BACKGROUND — ORANGE (RETROREFLECTIVE)





W20-5aL

W20-5aR  
2 LANES CLOSED  
(WITH DISTANCE)

\* The distance legend may be either AHEAD, XX FT, OR XX MILE(S) and Series C may be substituted where spacing limitations occur due to length of word message.

\*\* Reduce Spacing 20%.

A	B	C	D	E	F	G	H	J	K	L	M	N	P	Q
30	0.5	0.75	5 D	2.5	3.75 C	2.375	0.125	VAR	10.871**	1.684	0.504	12.050**	7.691	7.690
36	0.625	0.875	6 D	3	4.5 C	2.625	0.375	VAR	13.046**	2.020	0.605	14.460**	9.229	9.228
48	0.75	1.25	8 D	4	6 C	3.5	0.5	VAR	17.394**	2.693	0.807	19.280**	12.305	12.304

R	S	T	U	V	W	X	Y	Z	AA	BB	CC	DD	EE
6.315	6.815	9.041	2.5	12.050**	VAR	VAR	2.5	4.052	VAR	VAR	2.5	VAR	1.875
7.628	8.128	10.850	2.625	14.460**	VAR	VAR	2.625	4.862	VAR	VAR	3.125	VAR	2.25
10.258	10.75	14.466	3.5	19.280**	VAR	VAR	3.5	6.483	VAR	VAR	4	VAR	3

COLORS: LEGEND, BORDER — BLACK  
BACKGROUND — ORANGE (RETROREFLECTIVE)

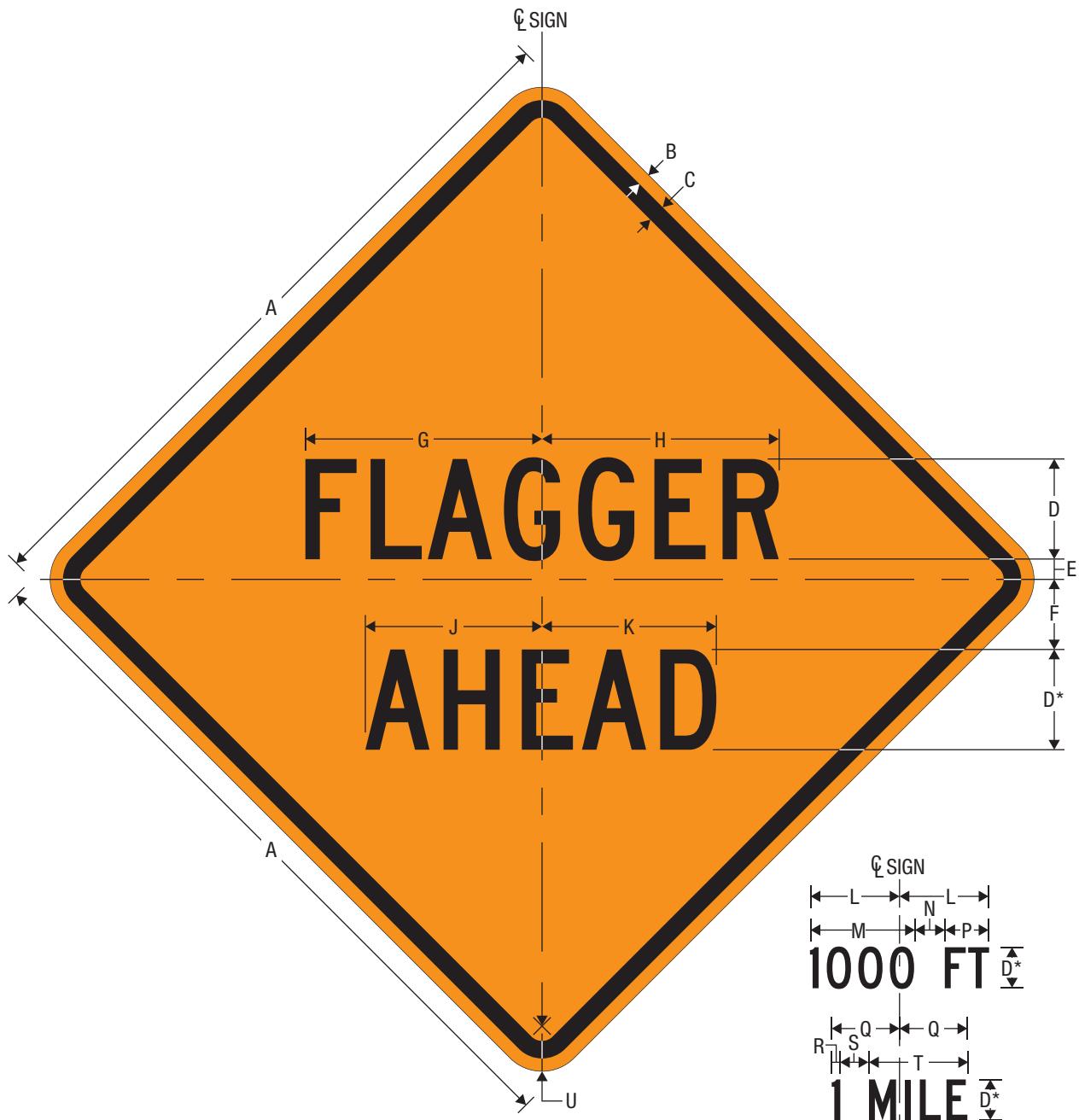

W20-7a  
FLAGGER

\* The distance legend may be either AHEAD, XX FT, OR XX MILE(S) and Series C may be substituted where spacing limitations occur due to length of word message.

A	B	C	D	E	F	G	H	J	K
30	0.5	0.75	4 C	0.875	2.875	9.444	9.443	7.003	7.002
36	0.625	0.875	5 C	1	3.5	11.805	11.804	8.753	8.753
48	0.75	1.25	7 C	2.5	3.75	16.526	16.526	12.255	12.254

L	M	N	P	Q	R	S	T	U
VAR	VAR	2.5	4.322	VAR	VAR	2.5	VAR	1.875
VAR	VAR	3.125	5.403	VAR	VAR	3.125	VAR	2.25
VAR	VAR	4.375	7.563	VAR	VAR	4	VAR	3

COLORS: LEGEND, BORDER — BLACK  
BACKGROUND — ORANGE (RETROREFLECTIVE)

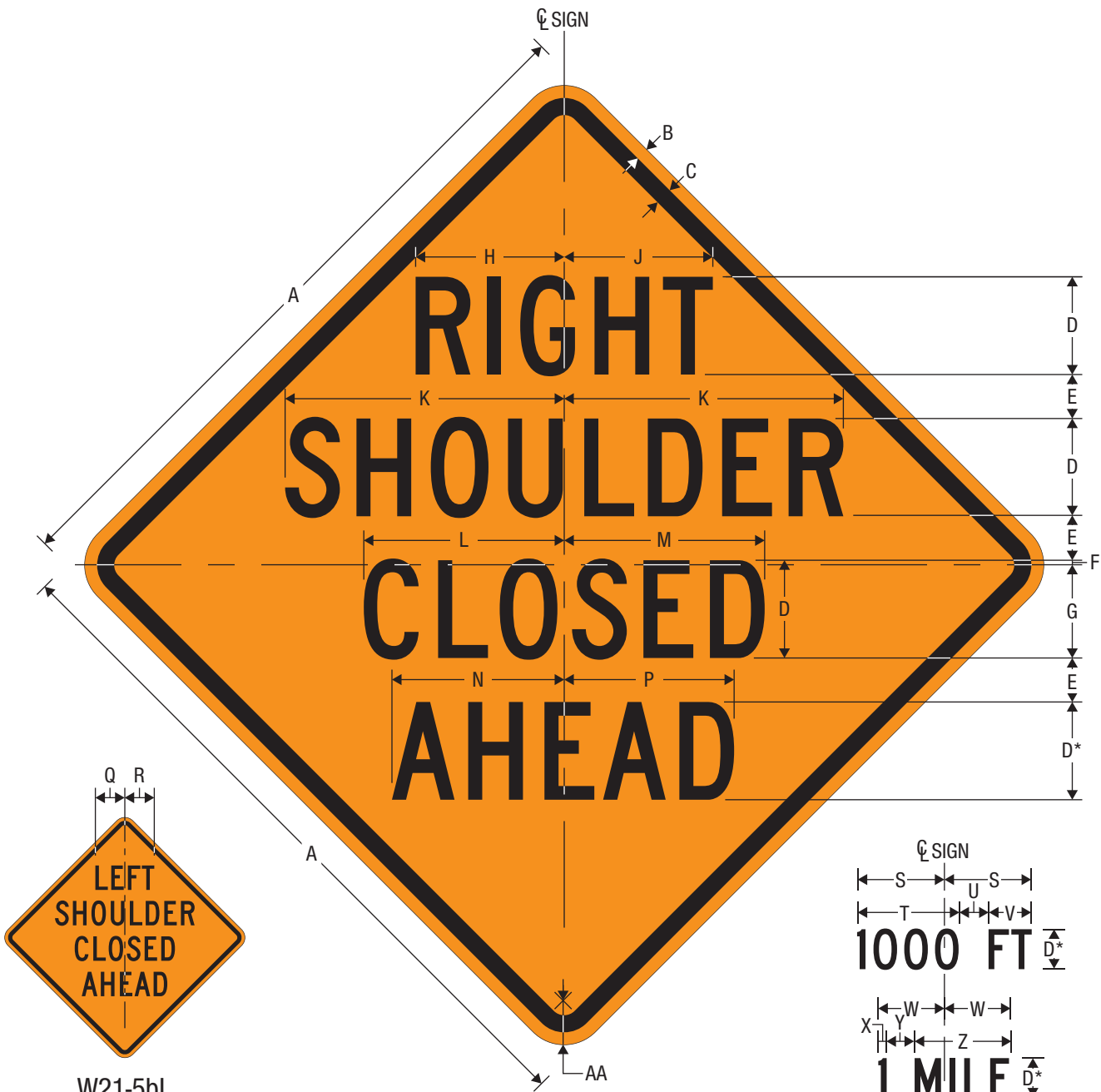

W21-5bL  
SHOULDER CLOSED  
(WITH DISTANCE)

W21-5bR  
SHOULDER CLOSED (WITH DISTANCE)

\* The distance legend may be either AHEAD, XX FT, OR XX MILE(S) and Series C may be substituted where spacing limitations occur due to length of word message.

A	B	C	D	E	F	G	H	J	K	L	M	N
30	0.5	0.75	4 C	2	0.25	3.75	6.082	6.082	11.424	8.203	8.203	7.003
36	0.625	0.875	5 C	2.25	0.25	4.75	7.603	7.602	14.280	10.254	10.254	8.753
48	0.75	1.25	6 C	3	0.25	5.75	9.123	9.123	17.136	12.305	12.305	10.504

P	Q	R	S	T	U	V	W	C	Y	Z	AA
7.002	4.822	4.822	VAR	VAR	2.75	4.322	VAR	VAR	3	VAR	1.875
8.753	6.028	6.027	VAR	VAR	3.5	5.403	VAR	VAR	3.5	VAR	2.25
10.504	7.233	7.233	VAR	VAR	4.25	6.483	VAR	VAR	4	VAR	3

COLORS: LEGEND, BORDER — BLACK  
BACKGROUND — ORANGE (RETROREFLECTIVE)

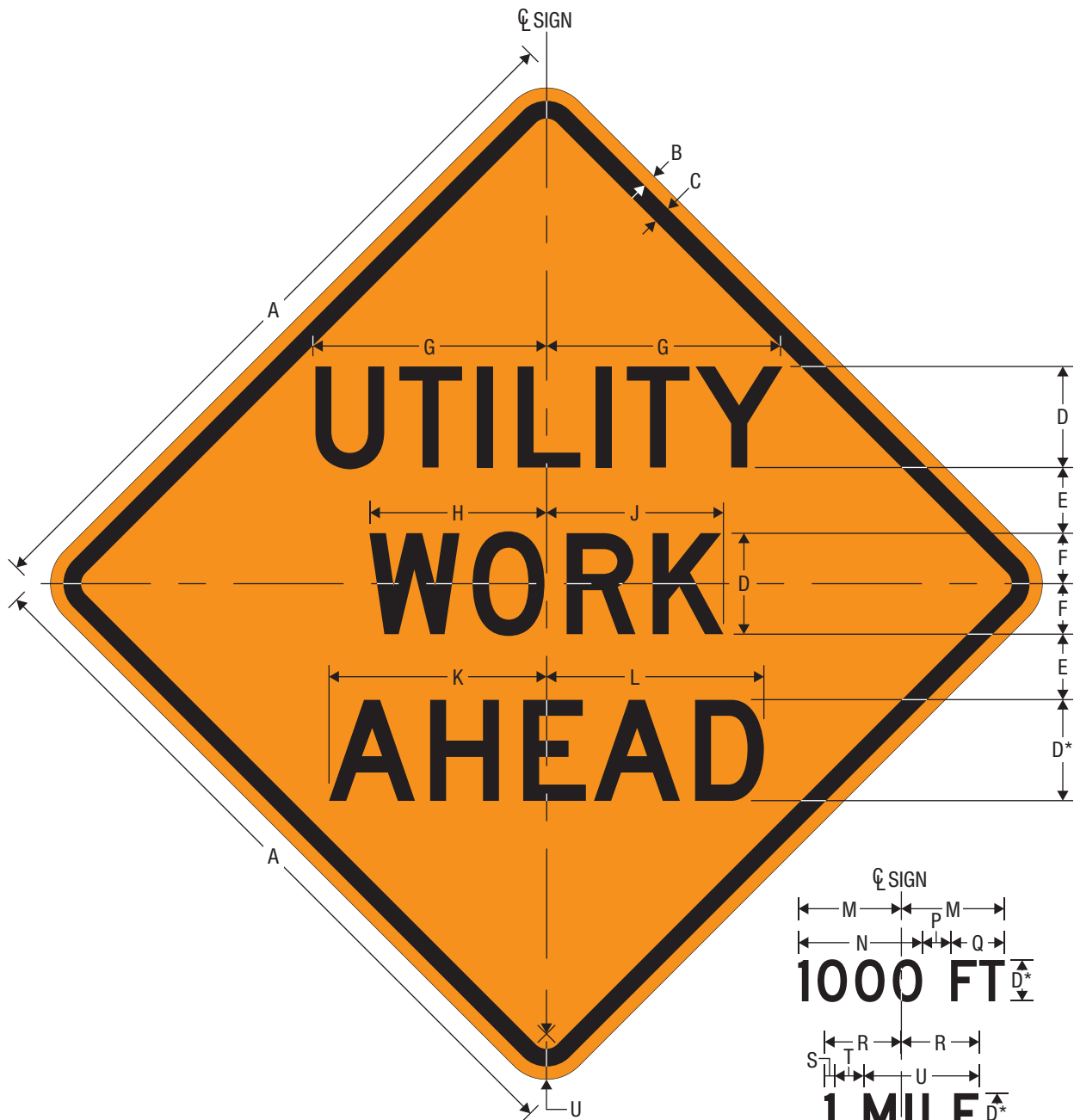

W21-7  
UTILITY WORK  
(WITH DISTANCE)

\* The distance legend may be either AHEAD, XX FT, OR XX MILE(S) and Series C may be substituted where spacing limitations occur due to length of word message.

\*\* Reduce Spacing 50%.

A	B	C	D	E	F	G	H	J	K
30	0.5	0.75	4 D	2.75	2	9.244	7.005	7.004	8.606
36	0.625	0.875	5 D	3.25	2.5	11.555	8.756	8.755	10.757
48	0.75	1.25	7 D**	3.75	3.5	14.602	12.258	12.258	15.060

L	M	N	P	Q	R	S	T	U
8.605	VAR	VAR	2.75	5.202	VAR	VAR	3	1.875
10.757	VAR	VAR	3.5	6.353	VAR	VAR	3.5	2.25
15.059	VAR	VAR**	4	8.894**	VAR	VAR	4	3

COLORS: LEGEND, BORDER — BLACK  
BACKGROUND — ORANGE (RETROREFLECTIVE)

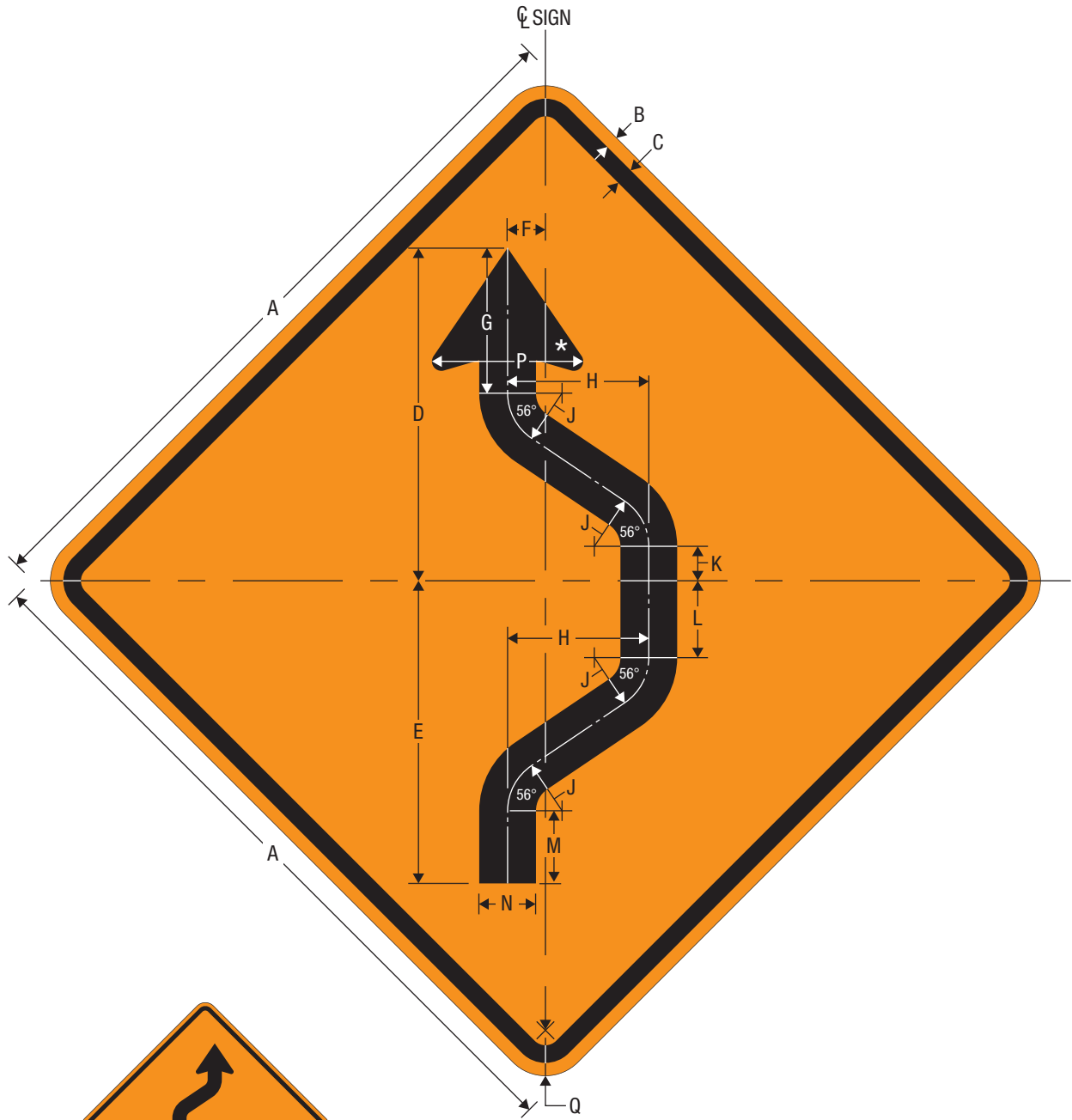

W24-1R

DOUBLE REVERSE CURVE (1 LANE)

W24-1L

DOUBLE REVERSE CURVE (1 LANE)

\* See page 7-3 for arrow design.

A	B	C	D	E	F	G	H	J	K	L	M	N	P	Q
30	0.5	0.75	13.75	12.5	1.563	6	5.833	2.25	1.423	3.173	3	2.344	6.25	1.875
36	0.625	0.875	16.5	15	1.875	7.200	7	2.700	1.708	3.808	3.6	2.813	7.5	2.25
48	0.75	1.25	22	20	2.5	9.600	9.333	3.600	2.277	5.077	4.8	3.75	10	3

COLORS: LEGEND, BORDER — BLACK  
BACKGROUND — ORANGE (RETROREFLECTIVE)

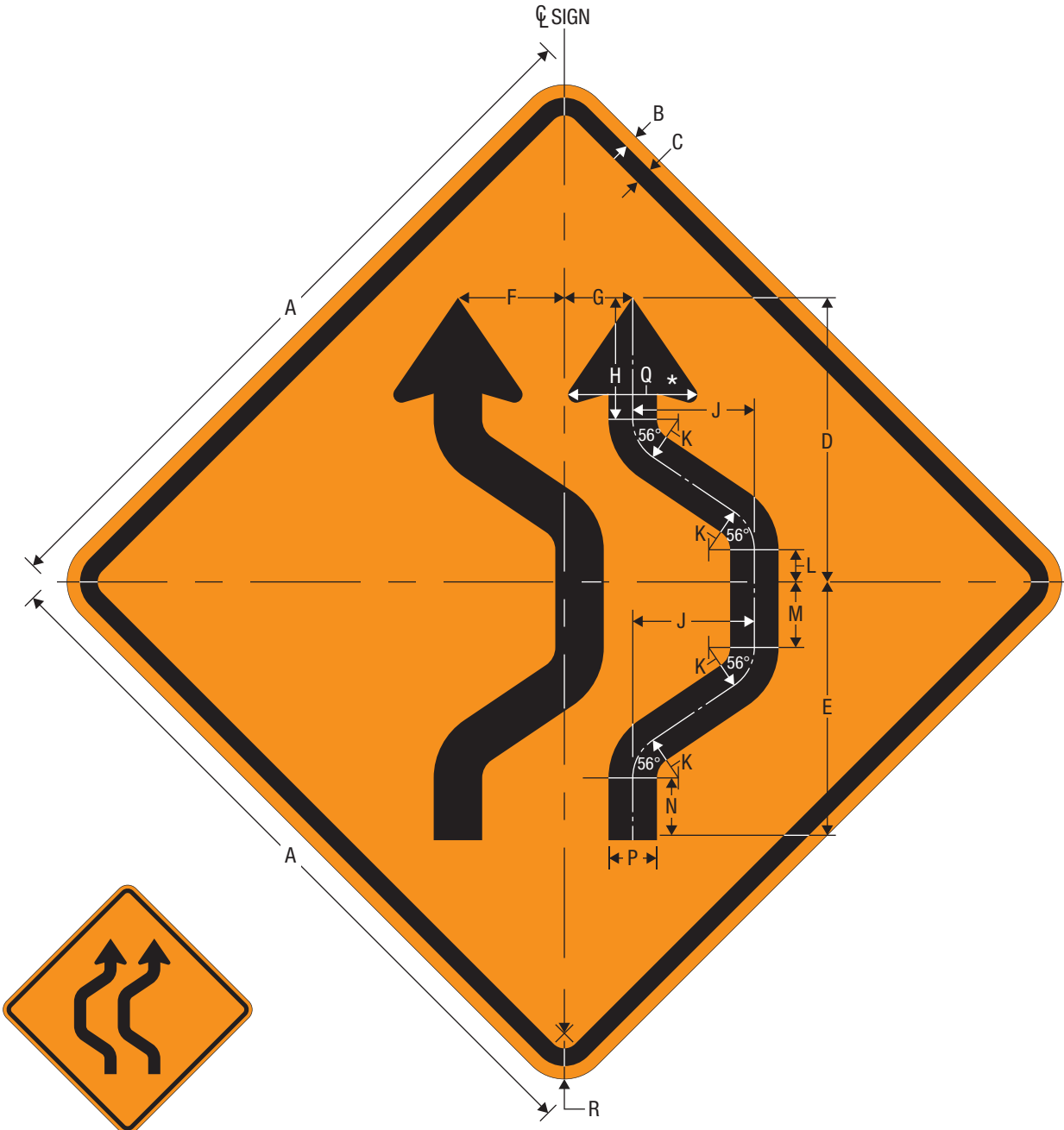

W24-1aL

DOUBLE REVERSE CURVE (2 LANES)

W24-1aR

DOUBLE REVERSE CURVE (2 LANES)

\* See page 7-3 for arrow design.

A	B	C	D	E	F	G	H
30	0.5	0.75	11.688	10.625	4.375	2.813	5
36	0.625	0.875	14.025	12.75	5.25	3.375	6
48	0.75	1.25	18.700	17	7	4.5	8

J	K	L	M	N	P	Q	R
5	1.875	1.321	2.696	2.563	1.992	5.313	1.875
6	2.25	1.585	3.235	3.075	2.391	6.375	2.25
8	3	2.114	4.314	4.100	3.188	8.5	3

COLORS: LEGEND, BORDER — BLACK  
BACKGROUND — ORANGE (RETROREFLECTIVE)

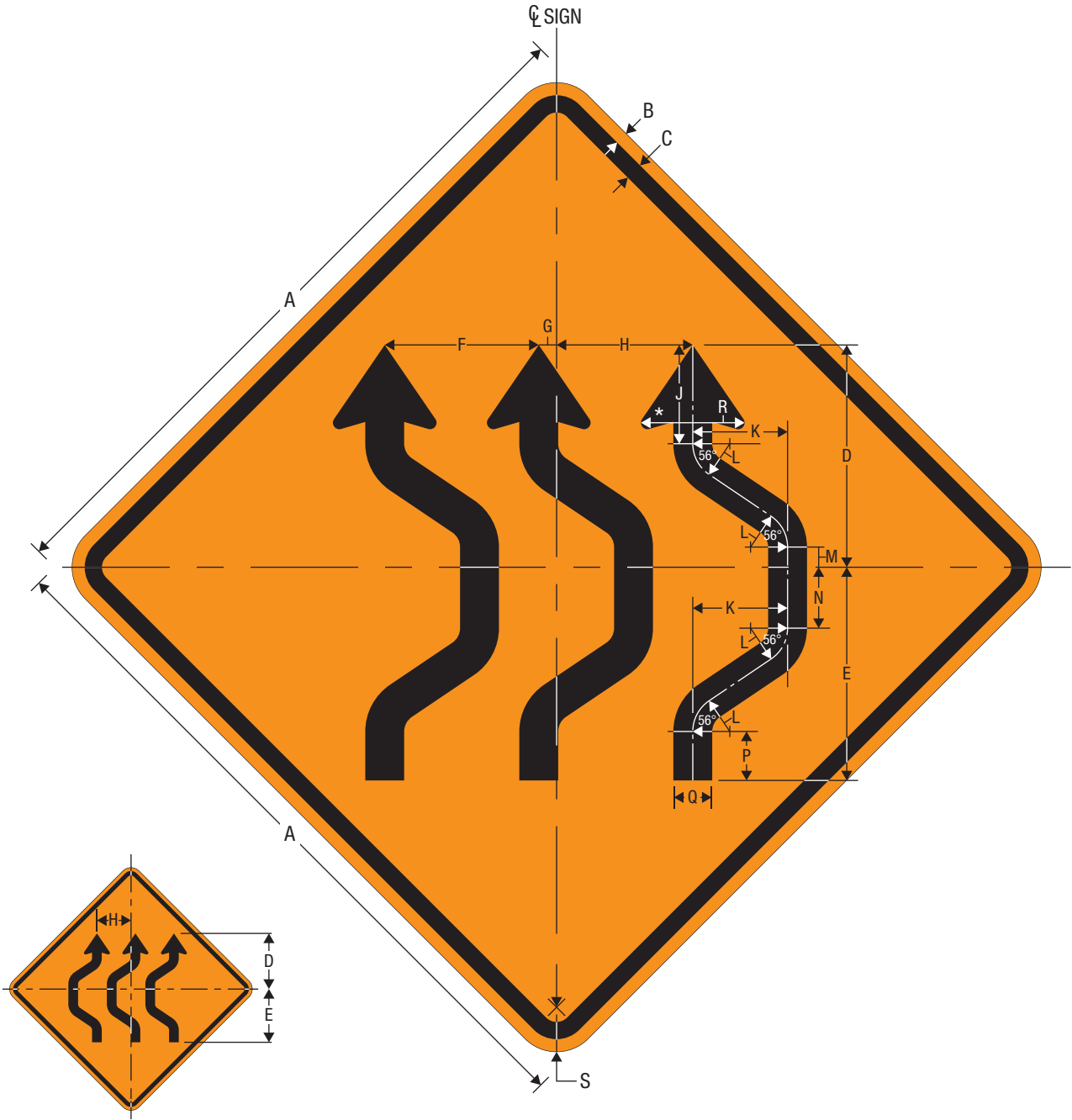

W24-1bL

DOUBLE REVERSE CURVE (3 LANES)

W24-1bR

DOUBLE REVERSE CURVE (3 LANES)

\* See page 7-3 for arrow design.

A	B	C	D	E	F	G	H	J
30	0.5	0.75	9.375	9	6.5	0.75	5.75	4.167
36	0.625	0.875	11.25	10.800	7.800	0.900	6.900	5
48	0.75	1.25	15	14.400	10.400	1.200	9.200	6.667

K	L	M	N	P	Q	R	S
4	1.563	0.849	2.574	2.067	1.641	4.375	1.875
4.800	1.875	1.018	3.088	2.480	1.969	5.25	2.25
6.400	2.5	1.358	4.118	3.307	2.625	7	3

COLORS: LEGEND, BORDER — BLACK  
BACKGROUND — ORANGE (RETROREFLECTIVE)

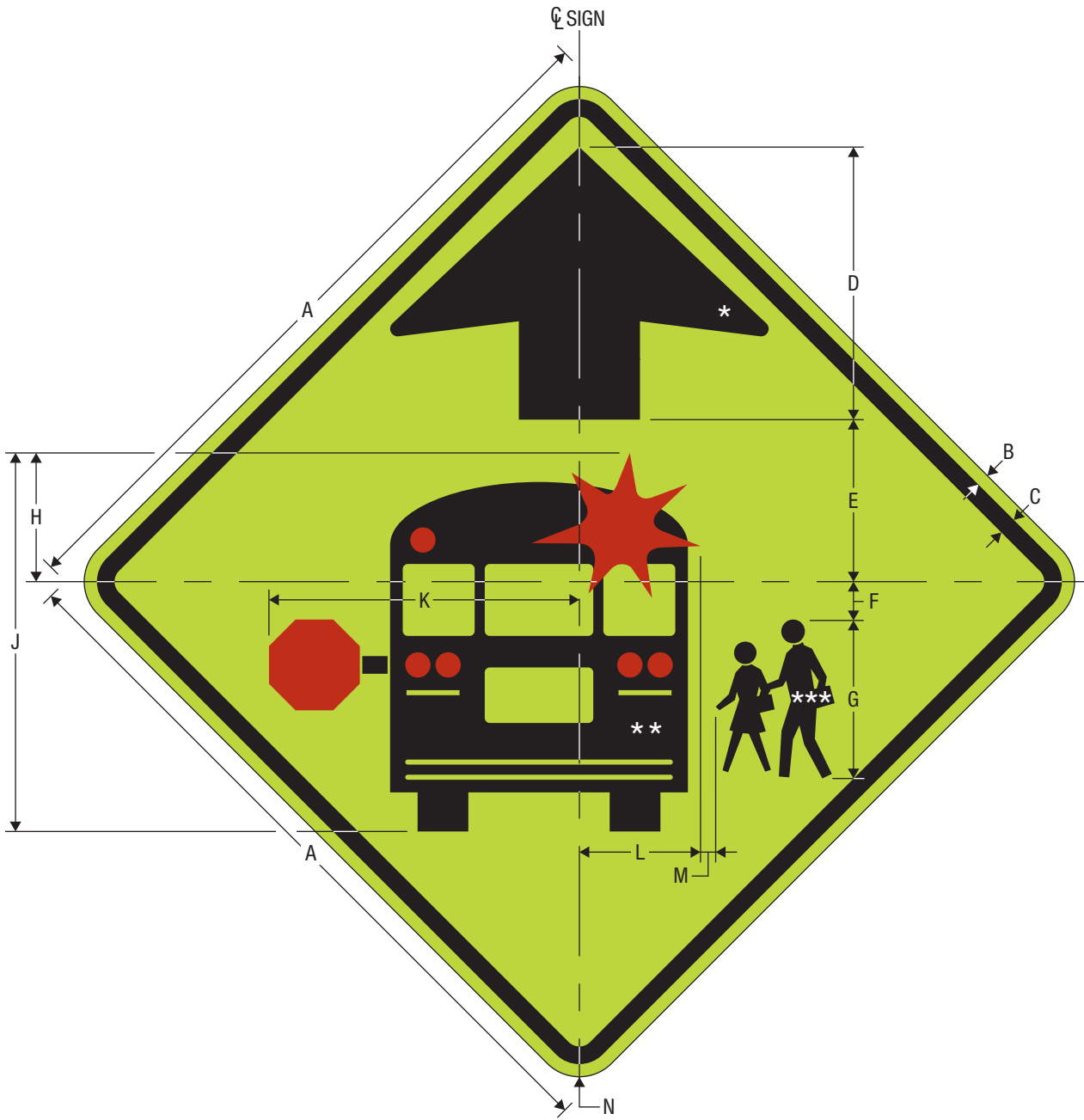

S3-1  
SCHOOL BUS STOP AHEAD

- \* See page 7-6 for arrow design.
- \*\* See page 8-23 for symbol design.
- \*\*\* See page 8-71 for symbol design.

A	B	C	D	E	F	G	H	J	K	L	M	N
30	0.5	0.75	11.25	15.625	5.375	6.683	1.5	6.625	12.813	5	0.625	1.875
36	0.625	0.875	13.5	18.75	6.375	8.024	1.875	7.875	15.375	6	0.75	2.25
48	0.75	1.25	18	25	8.5	10.689	2.5	10.5	20.5	8	1	3

COLORS: ARROW, BORDER — BLACK  
 SCHOOL BUS SYMBOL — BLACK, RED (RETROREFLECTIVE)  
 SCHOOLCHILDREN SYMBOL — BLACK  
 BACKGROUND — FLUORESCENT YELLOW-GREEN (RETROREFLECTIVE)





S4-5  
REDUCED SCHOOL SPEED LIMIT AHEAD

\* See page 7-6 for arrow design.  
\*\* Optically space numerals about centerline.

A	B	C	D	E	F	G	H	J	K	L	M	N	P
30	0.5	0.75	7.5	2.5	0.5	1.375	2 D	1.875	2 E	0.875	7.5 D**	1.5	12.5
36	0.625	0.875	9	3	1	1.625	2.5 D	2	2.5 E	1	9 D**	1.875	15
48	0.75	1.25	12	4	1.5	1.875	3 D	2.375	3 E	1.25	12 D**	2.25	18.5

Q	R	S	T	U	V	W	X	Y	Z	AA	BB	CC	DD
3.375	4.125	0.313	0.375	1.875	5.094	5.093	4.702	4.701	3.661	3.660	VAR**	7.5	1.875
4.125	4.875	0.375	0.5	2.25	6.367	6.367	5.877	5.877	4.576	4.575	VAR**	9	2.25
5.75	5.75	0.375	0.625	3	7.641	7.640	7.053	7.052	5.491	5.491	VAR**	12	3

COLORS: LEGEND, ARROW, BORDER — BLACK  
 INNER PANEL BACKGROUND — WHITE (RETROREFLECTIVE)  
 BACKGROUND — FLUORESCENT YELLOW GREEN (RETROREFLECTIVE)