



# **PART 8**

## **Traffic Controls for Highway-Rail Grade Crossings**

# **MUTCD 2000**

**Manual on Uniform Traffic Control Devices**

**m i l l e n n i u m e d i t i o n**

**December 2000**

**Incorporating:**

**Proposed Revision No. 2**

**Errata No. 1 dated June 14, 2001**



**U.S. Department  
of Transportation**

**Federal Highway  
Administration**



**PART 8. TRAFFIC CONTROLS FOR  
HIGHWAY-RAIL GRADE CROSSINGS**

**TABLE OF CONTENTS**

		<u>Page</u>
<b>CHAPTER 8A.</b>	<b>GENERAL .....</b>	
Section 8A.01	Introduction .....	8A-1
Section 8A.02	Use of Standard Devices, Systems, and Practices .....	8A-4
Section 8A.03	Uniform Provisions .....	8A-6
Section 8A.04	Highway-Rail Grade Crossing Elimination .....	8A-6
Section 8A.05	Temporary Traffic Control Zones .....	8A-7
<b>CHAPTER 8B.</b>	<b>SIGNS AND MARKINGS .....</b>	
Section 8B.01	Purpose .....	8B-1
Section 8B.02	Highway-Rail Grade Crossing (Crossbuck) Signs (R15-1, R15-2, R15-9) .....	8B-1
Section 8B.03	Highway-Rail Grade Crossing Advance Warning Signs (W10 Series) .....	8B-4
Section 8B.04	EXEMPT Highway-Rail Grade Crossing Signs (R15-3, W10-1a).....	8B-6
Section 8B.05	Turn Restrictions During Preemption.....	8B-7
Section 8B.06	DO NOT STOP ON TRACKS Sign (R8-8).....	8B-8
Section 8B.07	STOP (R1-1) or YIELD (R1-2) Signs at Highway-Rail Grade Crossings.....	8B-8
Section 8B.08	TRACKS OUT OF SERVICE Sign (R8-9) .....	8B-9
Section 8B.09	STOP HERE WHEN FLASHING Sign (R8-10) .....	8B-9
Section 8B.10	STOP HERE ON RED Sign (R10-6) .....	8B-10
Section 8B.11	Emergency Notification Sign (I-13 or I-13a).....	8B-10
Section 8B.12	TRAINS MAY EXCEED 130 km/h (80 MPH) Sign (W10-8) .....	8B-10
Section 8B.13	NO TRAIN HORN Sign (W10-9).....	8B-11
Section 8B.14	NO SIGNAL Sign (W10-10) or NO GATES OR LIGHTS Sign (W10-13).....	8B-11
Section 8B.15	LOOK Sign (R15-8) .....	8B-13
Section 8B.16	Low Ground Clearance Highway-Rail Grade Crossing Sign (W10-5).....	8B-13
Section 8B.17	Storage Space Signs (W10-11, W10-11a, W10-11b).....	8B-14
Section 8B.18	Skewed Crossing Sign (W10-12) .....	8B-14
Section 8B.19	Pavement Markings .....	8B-15
Section 8B.20	Stop Lines .....	8B-15
Section 8B.21	Dynamic Envelope Markings .....	8B-19

**CHAPTER 8C. ILLUMINATION . . . . .**

Section 8C.01 Illumination at Highway-Rail Grade Crossings .....8C-1

**CHAPTER 8D. FLASHING-LIGHT SIGNALS, GATES, AND TRAFFIC CONTROL SIGNALS . . . . .**

Section 8D.01 Introduction .....8D-1

Section 8D.02 Flashing-Light Signals, Post-Mounted.....8D-3

Section 8D.03 Flashing-Light Signals, Overhead Structures .....8D-5

Section 8D.04 Automatic Gates .....8D-5

Section 8D.05 Four-Quadrant Gate Systems .....8D-6

Section 8D.06 Train Detection .....8D-9

Section 8D.07 Traffic Control Signals at or Near Highway-Rail Grade Crossings .....8D-10

**FIGURES**

**CHAPTER 8A. GENERAL**

Figure 8A-1 Train Dynamic Envelope.....8A-2

**CHAPTER 8B. SIGNS AND MARKINGS**

Figure 8B-1 Highway-Rail Grade Crossing (Crossbuck) Signs .....8B-2

Figure 8B-2 Crossbuck Shield Sign (R15-9).....8B-3

Figure 8B-3 Advance Warning Signs .....8B-5

Figure 8B-4 Regulatory Signs.....8B-7

Figure 8B-5 Emergency Notification Signs .....8B-11

Figure 8B-6 Warning Signs.....8B-12

Figure 8B-7 Example of Placement of Warning Signs and Pavement Markings at Highway-Rail Grade Crossings .....8B-16

Figure 8B-8 Examples of Highway-Rail Grade Crossing Pavement Markings....8B-17

Figure 8B-9 Example of Train Dynamic Envelope Pavement Markings.....8B-18

**CHAPTER 8D. FLASHING LIGHT SIGNALS, GATES, AND TRAFFIC CONTROL SIGNALS**

Figure 8D-1 Composite Drawing of Active Traffic Control Devices for Highway-Rail Grade Crossings Showing Clearances.....8D-2

Figure 8D-2 Example of Location Plan for Flashing-Light Signals and Four-Quadrant Gates .....8D-8

## CHAPTER 8A. GENERAL

### Section 8A.01 Introduction

Support:

Traffic control for highway-rail grade crossings includes all signs, signals, markings, other warning devices, and their supports along highways approaching and at highway-rail grade crossings. The function of this traffic control is to permit safe and efficient operation of both rail and highway traffic at highway-rail grade crossings.

For purposes of installation, operation, and maintenance of traffic control devices at highway-rail grade crossings, it is recognized that the crossing of the highway and rail tracks is situated on a right-of-way available for the joint use of both highway traffic and railroad traffic.

The highway agency or authority with jurisdiction and the regulatory agency with statutory authority, if applicable, jointly determine the need and selection of devices at a highway-rail grade crossing.

In Part 8, the combination of devices selected or installed at a specific highway-rail grade crossing is referred to as a "traffic control system."

#### **Standard:**

**The traffic control devices, systems, and practices described herein shall be used at all highway-rail grade crossings open to public travel, consistent with Federal, State, and local laws and regulations.**

**To ensure an understanding of common terminology between highway and railroad signaling issues, the following definitions shall be used:**

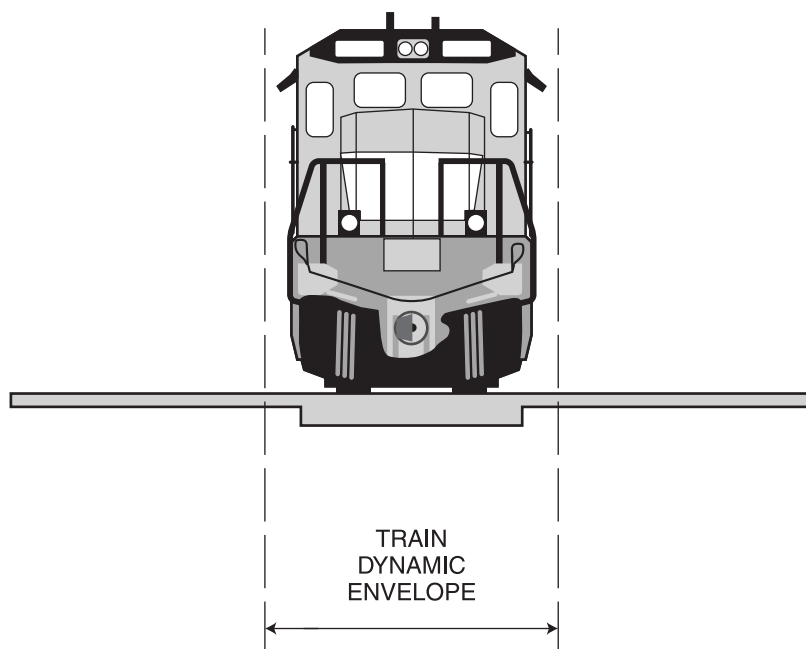
- 1. Advance Preemption—the notification of an approaching train that is forwarded to the highway traffic signal controller unit or assembly by the railroad equipment for a period of time prior to activating the railroad active warning devices.**
- 2. Advance Preemption Time—the period of time that is the difference between the maximum preemption time required for highway traffic signal operation and the minimum warning time needed for railroad operations.**
- 3. Cantilevered Signal Structure—a structure that is rigidly attached to a vertical pole and is used to provide overhead support of signal units.**
- 4. Clear Storage Distance—the distance available for vehicle storage measured between 1.8 m (6 ft) from the rail nearest the intersection to the intersection stop line or the normal stopping point on the highway. At skewed highway-**

rail grade crossings and intersections, the 1.8 m (6 ft) distance shall be measured perpendicular to the nearest rail either along the centerline or edge line of the highway, as appropriate, to obtain the shorter distance. Where exit lane gates are used, the distance available for vehicle storage is measured from the point where the rear of the vehicle would be clear of the exit lane gate arm. In cases where the exit lane gate arm is parallel to the track(s) and is not perpendicular to the highway, the distance is measured either along the centerline or edge line of the highway, as appropriate, to obtain the shorter distance.

5. **Design Vehicle**—the longest vehicle permitted by statute of the road authority (State or other) on that roadway.
6. **Dynamic Envelope**—the clearance required for the train and its cargo overhang due to any combination of loading, lateral motion, or suspension failure (see Figure 8A-1).
7. **Dynamic Exit Lane Gate Operating Mode**—a mode of operation where the exit lane gate operation is based on the presence of vehicles within the minimum track clearance distance.
8. **Exit Lane Gate Operating Mode**—for Four-Quadrant Gate systems, the mode of control used to govern the operation of the exit lane gate arms.

---

*Figure 8A-1. Train Dynamic Envelope*



- 9. Exit Lane Gate Clearance Time—**for Four-Quadrant Gate warning systems, the exit gate clearance time is the amount of time provided to delay the descent of the exit lane gate arm(s) after the approach lane gate arm(s) begin to descend.
- 10. Flashing-Light Signals—**a special type of highway traffic signal used at highway-rail grade crossings to inform drivers of the approach or presence of a train.
- 11. Interconnection—**the electrical connection between the railroad active warning system and the traffic signal controller assembly for the purpose of preemption.
- 12. Maximum Preemption Time—**the maximum amount of time needed following initiation of the preemption sequence for the highway traffic signals to complete the timing of the right-of-way transfer time, queue clearance time, and separation time.
- 13. Minimum Track Clearance Distance—**for standard two-quadrant railroad warning devices, the minimum track clearance distance is the length along a highway at one or more railroad tracks, measured either from the highway stop line, warning device, or 3.7 m (12 ft) perpendicular to the track centerline, to 1.8 m (6 ft) beyond the track(s) measured perpendicular to the far rail, along the centerline or edge line of the highway, as appropriate, to obtain the longer distance. For Four-Quadrant Gate systems, the minimum track clearance distance is the length along a highway at one or more railroad tracks, measured either from the highway stop line or entrance warning device, to the point where the rear of the vehicle would be clear of the exit lane gate arm. In cases where the exit lane gate arm is parallel to the track(s) and is not perpendicular to the highway, the distance is measured either along the centerline or edge of the highway, as appropriate, to obtain the longer distance.
- 14. Minimum Warning Time—Through Train Movements—**the least amount of time active warning devices shall operate prior to the arrival of a train at a highway-rail grade crossing.
- 15. Monitored Interconnected Operation—**an interconnected operation that has the capability to be monitored by the railroad company and/or highway authority at a location away from the highway-rail grade crossing.
- 16. Preemption—**the transfer of normal operation of traffic signals to a special control mode.
- 17. Presignal—**supplemental highway traffic signal faces operated as part of the

**highway intersection traffic signals, located in a position that controls traffic approaching the highway-rail grade crossing and intersection.**

- 18. Queue Clearance Time—the time required for the design vehicle of maximum length stopped just inside the minimum track clearance distance to start up and move through and clear the entire minimum track clearance distance. If presignals are present, this time shall be long enough to allow the vehicle to move through the intersection, or to clear the tracks if there is sufficient clear storage distance. If a Four-Quadrant Gate system is present, this time shall be long enough to permit the exit lane gate arm to lower after the design vehicle is clear of the minimum track clearance distance.**
- 19. Right-of-Way Transfer Time—the maximum amount of time needed for the worst case condition, prior to display of the track clearance green interval. This includes any railroad or traffic signal control equipment time to react to a preemption call, and any traffic signal green, pedestrian walk and clearance, yellow change, and red clearance intervals for conflicting traffic.**
- 20. Separation Time—the component of maximum preemption time during which the minimum track clearance distance is clear of vehicular traffic prior to the arrival of the train.**
- 21. Simultaneous Preemption—notification of an approaching train is forwarded to the highway traffic signal controller unit or assembly and railroad active warning devices at the same time.**
- 22. Timed Exit Gate Operating Mode—a mode of operation where the exit lane gate descent is based on a predetermined time interval.**
- 23. Vehicle Intrusion Detection Devices—a detector or detectors used as a part of a system incorporating processing logic to detect the presence of vehicles within the minimum track clearance distance and to control the operation of the exit lane gates.**
- 24. Wayside Equipment—the signals, switches, and/or control devices for railroad operations housed within one or more enclosures located along the railroad right-of-way and/or on railroad property.**

## **Section 8A.02 Use of Standard Devices, Systems, and Practices**

Support:

Because of the large number of significant variables to be considered, no single standard system of traffic control devices is universally applicable for all highway-rail grade crossings.



Guidance:

The appropriate traffic control system to be used at a highway-rail grade crossing should be determined by an engineering study involving both the highway agency and the railroad company.

Option:

The engineering study may include the Highway-Rail Intersection (HRI) components of the National Intelligent Transportation Systems (ITS) architecture, which is a USDOT accepted method for linking the highway, vehicles, and traffic management systems with rail operations and wayside equipment.

Support:

More detail on Highway-Rail Intersection components is available from USDOT's Federal Railroad Administration, 1120 Vermont Ave., NW, Washington, DC 20590, or [www.fra.dot.gov](http://www.fra.dot.gov).

**Standard:**

**Traffic control devices, systems, and practices shall be consistent with the design and application of the Standards contained herein.**

**Before any new highway-rail grade crossing traffic control system is installed or before modifications are made to an existing system, approval shall be obtained from the highway agency with the jurisdictional and/or statutory authority, and from the railroad company.**

Guidance:

To stimulate effective responses from drivers, pedestrians, and bicyclists, these devices, systems, and practices should use the five basic considerations employed generally for traffic control devices and described fully in Section 1A.02: design, placement, operation, maintenance, and uniformity.

Support:

Many other details of highway-rail grade crossing traffic control systems that are not set forth in Part 8 are contained in the references listed in Section 1A.11.

**Section 8A.03 Uniform Provisions****Standard:**

**All signs used in highway-rail grade crossing traffic control systems shall be retroreflectorized or illuminated as described in Section 2A.08 to show the same shape and similar color to an approaching road user during both day and night.**

**No sign or signal shall be located in the center of an undivided highway, except in an island with non-mountable curbs.**

**Guidance:**

Such signs or signals should be installed with a clearance of at least 0.6 m (2 ft) from the face of the curb to the nearest edge of the sign or signal, except as allowed in Section 2A.19.

Where the distance between tracks, measured along the highway between the inside rails, exceeds 30 m (100 ft), additional signs or other appropriate traffic control devices should be used.

**Section 8A.04 Highway-Rail Grade Crossing Elimination****Guidance:**

Because highway-rail grade crossings are a potential source of congestion, agencies should conduct engineering studies to determine the cost and benefits of eliminating these crossings.

**Standard:**

**When a highway-rail grade crossing is eliminated, the traffic control devices for the crossing shall be removed.**

**If the existing traffic control devices at a multiple-track highway-rail grade crossing become improperly placed or inaccurate because of the removal of some of the tracks, the existing devices shall be relocated and/or modified.**

**Guidance:**

Any highway-rail grade crossing that cannot be justified should be eliminated.

Where a roadway is removed from a highway-rail grade crossing, the roadway approaches in the railroad right-of-way should also be removed and appropriate signs should be placed at the roadway end in accordance with Section 3C.04.

Where a railroad is eliminated at a highway-rail grade crossing, the tracks should be removed or paved over.

**Option:**

The TRACKS OUT OF SERVICE (R8-9) sign (see Figure 8B-4) may be temporarily installed until the tracks are removed or paved over.

**Section 8A.05 Temporary Traffic Control Zones****Support:**

Temporary traffic control planning provides for continuity of operations (such as movement of traffic, pedestrians and bicycles, transit operations, and access to property/utilities) when the normal function of a roadway at a highway-rail grade crossing is suspended because of temporary traffic control operations.

**Standard:**

**Traffic controls for temporary traffic control zones that include highway-rail grade crossings shall be as outlined in Part 6.**

**When a highway-rail grade crossing exists either within or in the vicinity of a temporary traffic control zone, lane restrictions, flagging, or other operations shall not be performed in a manner that would cause vehicles to stop on the railroad tracks, unless a law enforcement officer or flagger is provided at the highway-rail grade crossing to minimize the possibility of vehicles stopping on the tracks, even if automatic warning devices are in place.**

**Guidance:**

Public and private agencies, including emergency services, businesses, and railroad companies, should meet to plan appropriate traffic detours and the necessary signing, marking, and flagging requirements for operations during temporary traffic control zone activities. Consideration should be given to the length of time that the highway-rail grade crossing is to be closed, the type of rail and highway traffic affected, the time of day, and the materials and techniques of repair.

Temporary traffic control operations should minimize the inconvenience, delay, and crash potential to affected traffic. Prior notice should be given to affected public or private agencies, emergency services, businesses, railroad companies, and road users before the free movement of vehicles or trains is infringed upon or blocked.

Temporary traffic control zone activities should not be permitted to extensively prolong the closing of the highway-rail grade crossing. The width and riding quality of the highway surface at a highway-rail grade crossing should, at a minimum, be restored to correspond with the quality of the approaches to the highway-rail grade crossing.

## CHAPTER 8B. SIGNS AND MARKINGS

### Section 8B.01 Purpose

Support:

Passive traffic control systems, consisting of signs and pavement markings, identify and direct attention to the location of a highway-rail grade crossing and advise drivers, bicyclists, and pedestrians to take appropriate action.

### Section 8B.02 Highway-Rail Grade Crossing (Crossbuck) Signs (R15-1, R15-2, R15-9)

**Standard:**

**The Highway-Rail Grade Crossing (R15-1) sign, commonly identified as the Crossbuck sign, shall be retroreflectorized white with the words RAILROAD CROSSING in black lettering, mounted as shown in Figure 8B-1.**

**As a minimum, one Crossbuck sign shall be used on each highway approach to every highway-rail grade crossing, alone or in combination with other traffic control devices.**

**If automatic gates are not present and if there are two or more tracks at the highway-rail grade crossing, the number of tracks shall be indicated on a supplemental Number of Tracks (R15-2) sign of inverted T shape mounted below the Crossbuck sign in the manner and at the height indicated in Figure 8B-1.**

Option:

The supplemental Number of Tracks sign may also be used at highway-rail grade crossings with automatic gates.

A Crossbuck Shield (R15-9) sign (see Figure 8B-2) may be mounted below the Crossbuck sign or Number of Tracks sign as shown in Figure 8B-1.

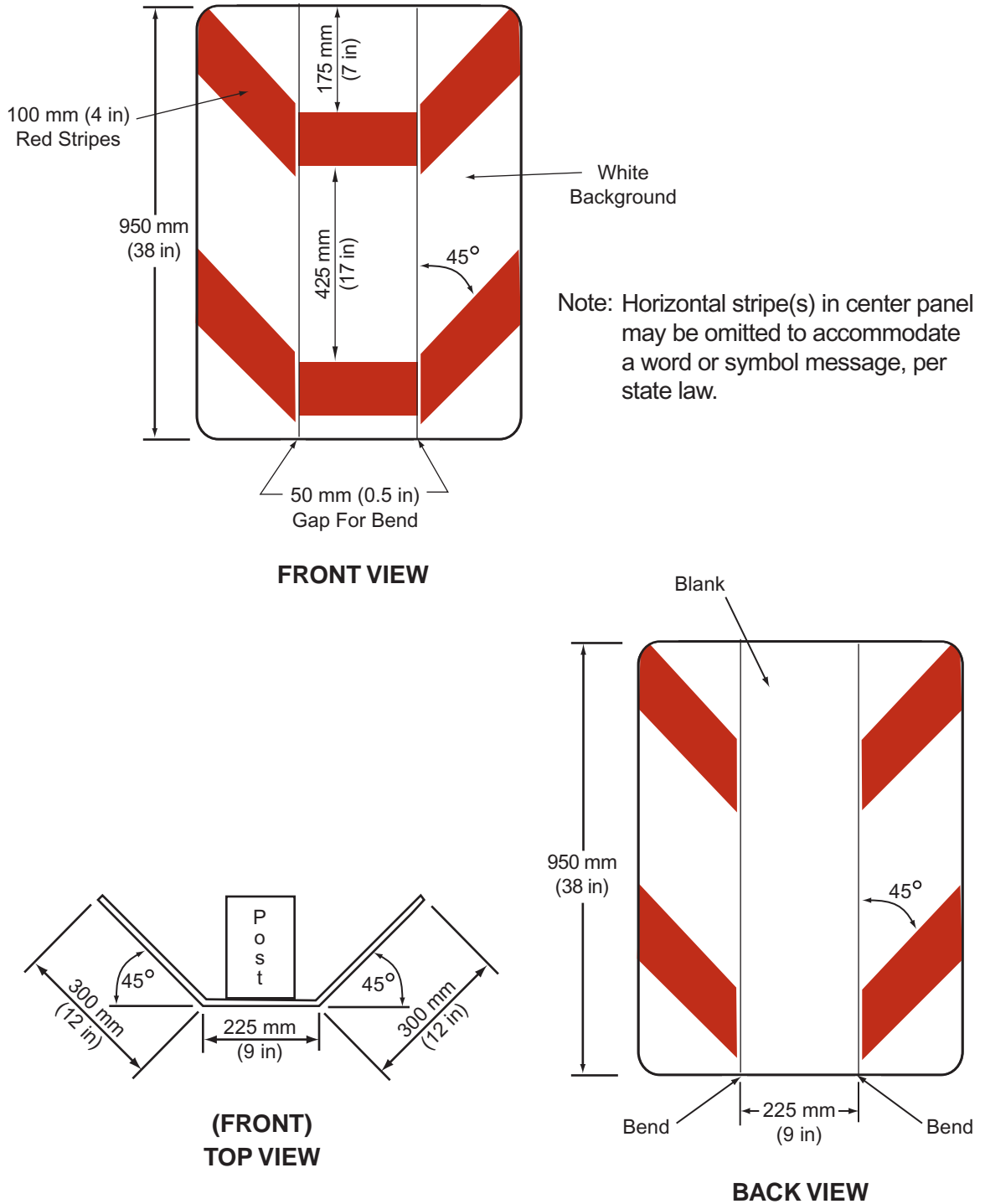
**Standard:**

**If the Crossbuck Shield sign is used, it shall consist of red retroreflective stripes on a white retroreflective background as shown in Figure 8B-2. The red stripes shall have a width of 100 mm (4 in).**

**If used, the Crossbuck Shield sign shall be mounted at a height of 750 mm (30 in) measured from the bottom of the sign to the roadway level.**



**Figure 8B-2. Crossbuck Shield Sign (R15-9)**



**The Crossbuck sign shall be installed on the right side of the highway on each approach to the highway-rail grade crossing. Where restricted sight distance or unfavorable highway geometry exists on an approach to a highway-rail grade crossing, an additional Crossbuck sign shall be installed on the left side of the highway, possibly placed back-to-back with the Crossbuck sign for the opposite approach, or otherwise located so that two Crossbuck signs are displayed for that approach.**

**A strip of retroreflective white material not less than 50 mm (2 in) in width shall be used on the back of each blade of each Crossbuck sign for the length of each blade, at all highway-rail grade crossings, except those where Crossbuck signs have been installed back-to-back.**

**A strip of retroreflective white material, not less than 50 mm (2 in) in width, shall be used on each support at highway-rail grade crossings for the full length of the front and back of the support from the Crossbuck sign or Number of Tracks sign to within 0.3 m (1 ft) of the ground level, except on the side of those supports where a Crossbuck Shield sign or flashing lights have been installed.**

Guidance:

Crossbuck signs should be located with respect to the highway pavement or shoulder in accordance with the criteria in Chapter 2A and Figures 2A-1 and 2A-2, and should be located with respect to the nearest track in accordance with Figure 8D-2.

The minimum lateral clearance for the nearest edge of the Crossbuck sign should be 1.8 m (6 ft) from the edge of the shoulder, or 3.7 m (12 ft) from the edge of the traveled way in rural areas (whichever is greater), and 0.6 m (2 ft) from the face of the curb in urban areas.

Where unusual conditions make variations in location and lateral clearance appropriate, engineering judgment should be used to provide the best practical combination of view and safety clearances.

### **Section 8B.03 Highway-Rail Grade Crossing Advance Warning Signs (W10 Series)**

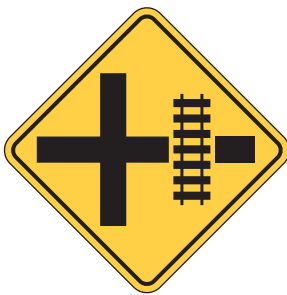
**Standard:**

**A Highway-Rail Grade Crossing Advance Warning (W10-1) sign (see Figure 8B-3) shall be used on each highway in advance of every highway-rail grade crossing except in the following circumstances:**



**Figure 8B-3. Advance Warning Signs**

W10-1



W10-2



W10-3



W10-4

- 
- A. On an approach to a highway-rail grade crossing from a T-intersection with a parallel highway, if the distance from the edge of the track to the edge of the parallel roadway is less than 30 m (100 ft), and W10-3 signs are used on both approaches of the parallel highway; or
  - B. On low-volume, low-speed highways crossing minor spurs or other tracks that are infrequently used and are flagged by train crews; or
  - C. In business districts where active highway-rail grade crossing traffic control devices are in use; or
  - D. Where physical conditions do not permit even a partially effective display of the sign.

**Placement of the Highway-Rail Grade Crossing Advance Warning sign shall be in accordance with Chapter 2A and Table 2C-4.**

Option:

On divided highways and one-way streets, an additional W10-1 sign may be installed on the left side of the roadway.

**Standard:**

**If the distance between the railroad tracks and a parallel highway, from the edge of the tracks to the edge of the parallel roadway, is less than 30 m (100 ft), W10-2, W10-3, or W10-4 signs (see Figure 8B-3) shall be installed on each approach of the parallel highway to warn road users making a turn that they will encounter a highway-rail grade crossing soon after making a turn, and a W10-1 sign for the approach to the tracks shall not be required to be between the tracks and the parallel highway.**

**If the W10-2, W10-3, or W10-4 signs are used, sign placement shall be in accordance with Table 2C-4 (using the speed of the turning maneuver), and shall be measured from the highway intersection.**

**Guidance:**

If the distance between the railroad tracks and the parallel highway, from the edge of the tracks to the edge of the parallel roadway, is 30 m (100 ft) or more, a W10-1 sign should be installed in advance of the highway-rail grade crossing, and the W10-2, W10-3, or W10-4 signs should not be used on the parallel highway.

**Section 8B.04 EXEMPT Highway-Rail Grade Crossing Signs (R15-3, W10-1a)****Option:**

When authorized by law or regulation, a supplemental EXEMPT (R15-3) sign (see Figure 8B-4) with a white background bearing the word EXEMPT may be used below the Crossbuck sign or Number of Tracks sign, if present, at the highway-rail grade crossing, and a supplemental EXEMPT (W10-1a) sign (see Figure 8B-4) with a yellow background bearing the word EXEMPT may be used below the Highway-Rail Advance Warning (W10-1) sign.

**Support:**

These supplemental signs inform drivers of vehicles carrying passengers for hire, school buses carrying students, or vehicles carrying hazardous materials that a stop is not required at certain designated highway-rail grade crossings, except when a train, locomotive, or other railroad equipment is approaching or occupying the highway-rail grade crossing, or the driver's view is blocked.

**Section 8B.05 Turn Restrictions During Preemption**

Guidance:

At a signalized intersection that is located within 60 m (200 ft) of a highway-rail grade crossing, measured from the edge of the track to the edge of the roadway, where the intersection traffic control signals are preempted by the approach of a train, all existing turning movements toward the highway-rail grade crossing should be prohibited during the signal preemption sequences.

Option:

A blank-out or changeable message sign and/or appropriate traffic signal indication or other similar type sign may be used to prohibit turning movements toward the highway-rail grade crossing during preemption. The R3-1a and R3-2a signs shown in Figure 8B-4 may be used for this purpose.

**Figure 8B-4. Regulatory Signs**



R3-1a  
Activated Blank-Out



R3-2a  
Activated Blank-Out



R8-8



R8-9



R8-10



R10-6



R10-11a



R15-8



R15-3 White background  
W10-1a Yellow background

**Standard:**

**Turn prohibition signs that are associated with preemption shall be visible only when the highway-rail grade crossing restriction is in effect.**

**Section 8B.06 DO NOT STOP ON TRACKS Sign (R8-8)**

## Guidance:

Whenever engineering judgment determines that the potential for vehicles stopping on the tracks is high, a DO NOT STOP ON TRACKS (R8-8) sign (see Figure 8B-4) should be used.

The sign, if used, should be located on the right side of the highway on either the near or far side of the highway-rail grade crossing, depending upon which side provides better visibility to approaching drivers.

## Option:

DO NOT STOP ON TRACKS signs may be placed on both sides of the track.

On divided highways and one-way streets, a second DO NOT STOP ON TRACKS sign may be placed on the near or far left side of the highway-rail grade crossing to further improve visibility of the sign.

**Section 8B.07 STOP (R1-1) or YIELD (R1-2) Signs at Highway-Rail Grade Crossings**

## Option:

At the discretion of the responsible State or local highway agency, STOP (R1-1) or YIELD (R1-2) signs (see Figure 2B-1) may be used at highway-rail grade crossings that have two or more trains per day and are without automatic traffic control devices.

## Support:

Two or more trains per day means an average of two or more trains per day operating over the highway-rail grade crossing for a 12-month period prior to the installation of the STOP or YIELD control sign.

## Option:

For other highway-rail grade crossings with passive warning devices, STOP or YIELD signs may be used based on an engineering study.

**Guidance:**

The engineering study should take into consideration such factors as highway and train traffic characteristics (including volume and speed), collision history, the need for active control devices, and sight distance to the approaching train.

**Option:**

If a STOP or YIELD sign is installed at a highway-rail grade crossing, it may be installed on the Crossbuck post or on a separate post at a point where the vehicle is to stop, or as near to that point as practical.

**Standard:**

**For all highway-rail grade crossings where STOP or YIELD signs are installed, the placement shall conform to the requirements of Sections 2B.06 and 2B.10. Stop Ahead (W3-1a) or Yield Ahead (W3-2a) Advance Warning signs (see Figure 2C-5) shall also be installed if the criteria for their installation given in Section 2C.26 is met.**

**Section 8B.08 TRACKS OUT OF SERVICE Sign (R8-9)****Option:**

The TRACKS OUT OF SERVICE (R8-9) sign (see Figure 8B-4) may be used at a highway-rail grade crossing instead of a Crossbuck (R15-1) sign and a Number of Tracks (R15-2) sign (see Figure 8B-1) when railroad tracks have been temporarily or permanently abandoned, but only until such time that the tracks are removed or paved over.

**Standard:**

**When tracks are out of service, traffic control devices and gate arms shall be removed and the signal heads shall be removed or hooded or turned from view to clearly indicate that they are not in operation.**

**The R8-9 sign shall be removed when the tracks have been removed or covered or when the highway-rail grade crossing is returned to service.**

**Section 8B.09 STOP HERE WHEN FLASHING Sign (R8-10)****Option:**

The STOP HERE WHEN FLASHING (R8-10) sign (see Figure 8B-4) may be used at a highway-rail grade crossing to inform drivers of the location of the stop line or the point at which to stop when the flashing-light signals (see Section 8D.02) are activated.

**Section 8B.10 STOP HERE ON RED Sign (R10-6)**

## Support:

The STOP HERE ON RED (R10-6) sign (see Figure 8B-4) defines and facilitates observance of stop lines at traffic signals or traffic gates.

## Option:

A STOP HERE ON RED sign may be used at locations where vehicles frequently violate the stop line or where it is not obvious to road users where to stop.

## Guidance:

If possible, stop lines should be placed at a point where the vehicle driver has adequate sight distance along the track.

**Section 8B.11 Emergency Notification Sign (I-13 or I-13a)**

## Guidance:

An Emergency Notification (I-13 or I-13a) sign (see Figure 8B-5) should be installed at all highway-rail grade crossings to provide for emergency notification. The sign should have a white message on blue background.

Location and placement should be decided cooperatively by the railroad company and the public or private highway agencies based on specific site conditions. However, these signs are typically located on the railroad right-of-way.

This sign, which is for emergency notification, should convey a clear and simple message that is visible to anyone stalled or disabled on the railroad tracks, and to anyone with other emergencies.

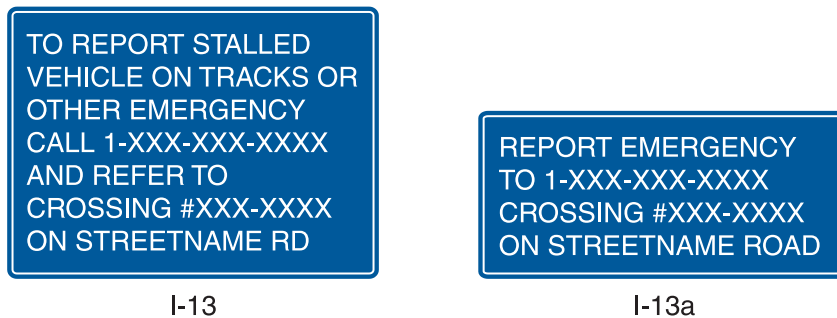
## Support:

Typical sign messages are shown in Figure 8B-5.

**Section 8B.12 TRAINS MAY EXCEED 130 km/h (80 MPH) Sign (W10-8)**

## Guidance:

Where trains are permitted to travel at speeds exceeding 130 km/h (80 mph), a TRAINS MAY EXCEED 130 km/h (80 MPH) (W10-8) sign (see Figure 8B-6) should be installed facing road users approaching the highway-rail grade crossing.

**Figure 8B-5. Emergency Notification Signs**


---

If used, the TRAINS MAY EXCEED 130 km/h (80 MPH) signs should be installed between the Highway-Rail Grade Crossing Advance Warning (W10-1) sign (see Figure 8B-3) and the highway-rail grade crossing on all approaches to the highway-rail grade crossing. The locations should be determined based on specific site conditions.

### **Section 8B.13 NO TRAIN HORN Sign (W10-9)**

#### **Standard:**

A NO TRAIN HORN (W10-9) sign (see Figure 8B-6) shall be installed at each highway-rail grade crossing where there is a Federal Railroad Administration authorization for trains to not sound a horn. The sign shall be mounted as a supplemental plaque below the Highway-Rail Grade Crossing Advance Warning (W10-1) sign (see Figure 8B-3).

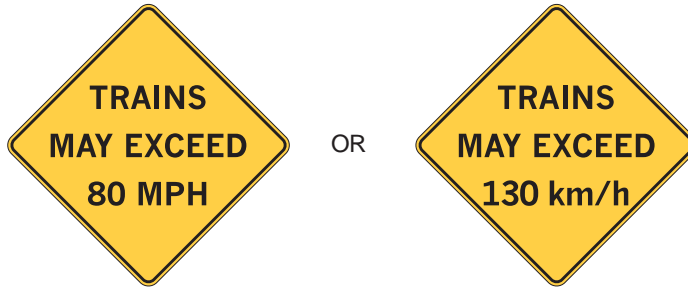
### **Section 8B.14 NO SIGNAL Sign (W10-10) or NO GATES OR LIGHTS Sign (W10-13)**

#### **Option:**

A NO SIGNAL (W10-10) sign or a NO GATES OR LIGHTS (W10-13) sign (see Figure 8B-6) may be installed at highway-rail grade crossings that are not equipped with automated signals.

The NO SIGNAL (W10-10) sign or the NO GATES OR LIGHTS (W10-13) sign may be mounted as a supplemental plaque below the Advance Warning (W10-1) sign.

**Figure 8B-6. Warning Signs**



W10-8



W10-9



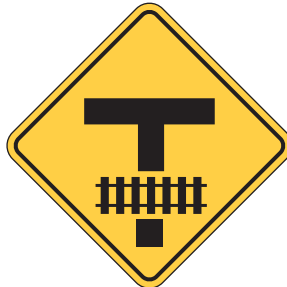
W10-10



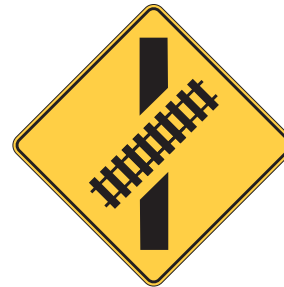
W10-13



W10-5



W10-11



W10-12



W10-11a

OR



W10-11b

OR



Note: The W10-11 sign is a W10-3 sign modified for geometrics. Other signs can be oriented or revised as needed to satisfy the geometrics of the roadways and the railroad tracks.



**Section 8B.15 LOOK Sign (R15-8)****Option:**

At highway-rail grade crossings, the LOOK (R15-8) sign (see Figure 8B-4) may be mounted as a supplemental plaque on the Crossbuck (R15-1) sign post, or as a separate sign in the immediate vicinity of the highway-rail grade crossing on the railroad right-of-way.

**Section 8B.16 Low Ground Clearance Highway-Rail Grade Crossing Sign (W10-5)****Guidance:**

If the highway profile conditions are sufficiently abrupt to create a hang-up situation for long wheelbase vehicles or for trailers with low ground clearance, the Low Ground Clearance Highway-Rail Grade Crossing (W10-5) sign (see Figure 8B-6) should be installed in advance of the highway-rail grade crossing.

**Standard:**

**New warning signs such as this that might not be readily recognizable by the public shall be accompanied by an educational plaque, LOW GROUND CLEARANCE which is to remain in place for at least 3 years after its initial installation (see Section 2A.13).**

**Guidance:**

Auxiliary signs such as AHEAD, NEXT CROSSING, or USE NEXT CROSSING (with appropriate arrows) should be placed at the nearest intersecting highway where a vehicle can detour or at a point on the highway wide enough to permit a U-turn.

If engineering judgment of roadway geometric and operating conditions confirms that vehicle speeds across the railroad tracks should be below the posted speed limit, a W13-1 advisory speed plaque should be posted.

**Option:**

If the highway-rail grade crossing is rough, word message signs such as BUMP, DIP, or ROUGH CROSSING may be installed. A W13-1 advisory speed plaque may be installed below the word message sign in advance of rough crossings.

**Support:**

Information on railroad ground clearance requirements is also available in the "American Railway Engineering and Maintenance-of-Way Association's Engineering Manual," or the American Association of State Highway and Transportation Officials' "Policy on Geometric Design of Highways and Streets" (see Section 1A.11).

**Section 8B.17 Storage Space Signs (W10-11, W10-11a, W10-11b)****Guidance:**

A Storage Space (W10-11) sign supplemented by a word message storage distance (W10-11a) sign (see Figure 8B-6) should be used where there is a highway intersection in close proximity to the highway-rail grade crossing and an engineering study determines that adequate space is not available to store a design vehicle(s) between the highway intersection and the train dynamic envelope.

The Storage Space (W10-11 and W10-11a) signs should be mounted in advance of the highway-rail grade crossing at an appropriate location to advise drivers of the space available for vehicle storage between the highway intersection and the highway-rail grade crossing.

**Option:**

A Storage Space (W10-11b) sign (see Figure 8B-6) may be mounted beyond the highway-rail grade crossing at the highway intersection under the STOP or YIELD sign or just prior to the signalized intersection to remind drivers of the storage space between the tracks and the highway intersection.

**Section 8B.18 Skewed Crossing Sign (W10-12)****Option:**

The Skewed Crossing (W10-12) sign (see Figure 8B-6) may be used at a skewed highway-rail grade crossing to warn drivers that the railroad tracks are not perpendicular to the highway.

**Guidance:**

If used, the symbol on the Skewed Crossing sign should show the direction and approximate angle of the crossing.

**Standard:**

**The Skewed Crossing sign shall not be used as a replacement for the required Advance Warning (W10-1) sign. If used, the Skewed Crossing sign shall supplement the W10-1 sign and shall be mounted on a separate post.**

**Section 8B.19 Pavement Markings****Standard:**

**All highway-rail grade crossing pavement markings shall be retroreflectorized white. All other markings shall be in accordance with Part 3.**

**Pavement markings in advance of a highway-rail grade crossing shall consist of an X, the letters RR, a no-passing marking (two-lane highways), and certain transverse lines as shown in Figures 8B-7 and 8B-8.**

**Identical markings shall be placed in each approach lane on all paved approaches to highway-rail grade crossings where signals or automatic gates are located, and at all other highway-rail grade crossings where the posted or statutory highway speed is 60 km/h (40 mph) or greater.**

**Pavement markings shall not be required at highway-rail grade crossings where the posted or statutory highway speed is less than 60 km/h (40 mph), or in urban areas, if an engineering study indicates that other installed devices provide suitable warning and control.**

**Guidance:**

When pavement markings are used, a portion of the X symbol should be directly opposite the Advance Warning sign. The X symbol and letters should be elongated to allow for the low angle at which they will be viewed.

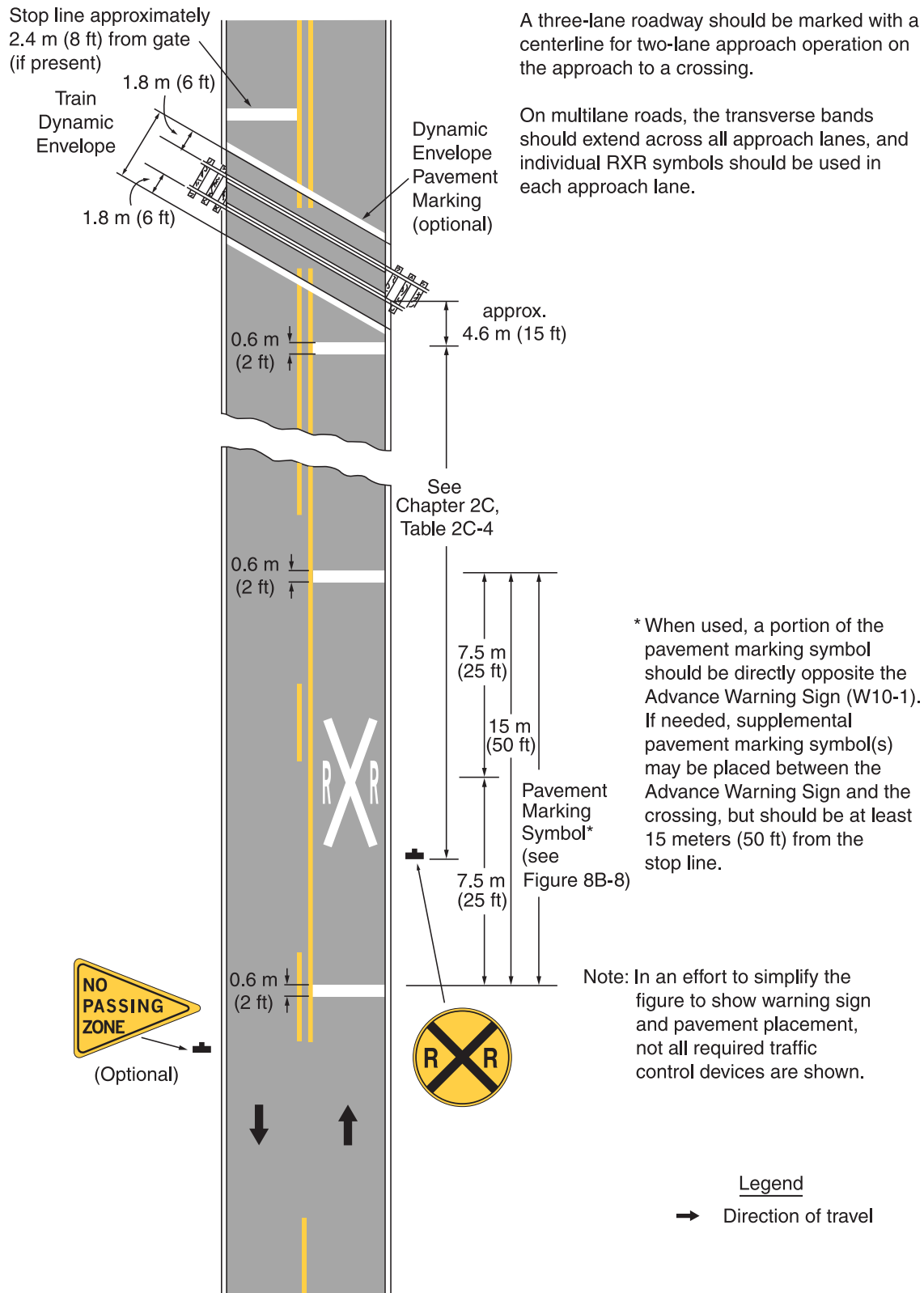
**Option:**

When justified by engineering judgment, supplemental pavement marking symbol(s) may be placed between the Advance Warning sign and the highway-rail grade crossing.

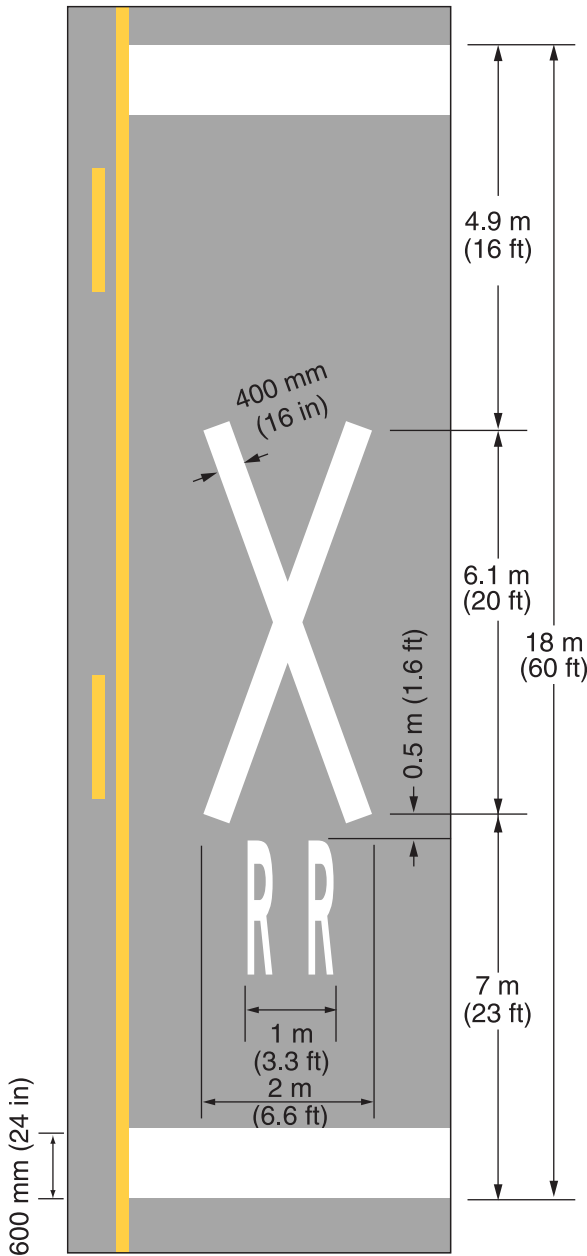
**Section 8B.20 Stop Lines****Guidance:**

The stop line should be a transverse line at a right angle to the traveled way at a point where a vehicle is to stop or as near to that point as possible. The stop line should be placed approximately 2.4 m (8 ft) from the gate (if present), but no closer than 4.6 m (15 ft) from the nearest rail.

**Figure 8B-7. Example of Placement of Warning Signs and Pavement Markings at Highway-Rail Grade Crossings**

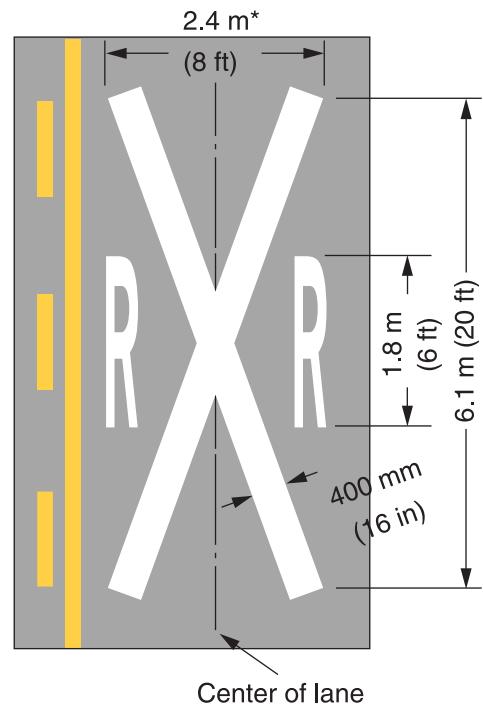


**Figure 8B-8. Examples of Highway-Rail Grade Crossing Pavement Markings**



**Highway-rail grade crossing alternative (narrow) pavement markings**

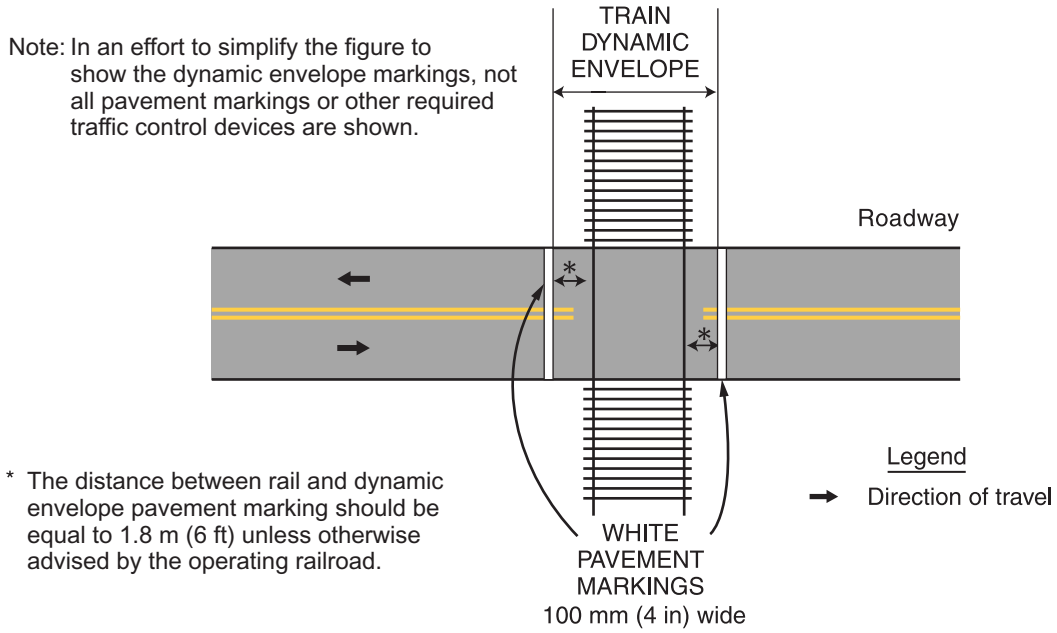
Note: Refer to Figure 8B-7 for placement



**Highway-rail grade crossing pavement markings**

\*Width may vary according to lane width

**Figure 8B-9. Example of Train Dynamic Envelope Pavement Markings**



**Section 8B.21 Dynamic Envelope Markings****Option:**

Dynamic envelope markings may be used to mark the edges of the dynamic envelope where there is a highway intersection in close proximity to the highway-rail grade crossing and an engineering study determines that vehicles might stop within the dynamic envelope area.

Dynamic envelope markings may be installed at all highway-rail grade crossings, unless a Four-Quadrant Gate system (see Section 8D.05) is used.

**Standard:**

**If used, pavement markings for indicating the dynamic envelope shall conform to Part 3 and shall be a 100 mm (4 in) normal solid white line or contrasting pavement color and/or contrasting pavement texture.**

**Guidance:**

If used, dynamic envelope pavement markings should be placed on the highway 1.8 m (6 ft) from the nearest rail, installed parallel to the tracks, unless the operating railroad company advises otherwise. The pavement markings should extend across the roadway as shown in Figure 8B-9.





## CHAPTER 8C. ILLUMINATION

### Section 8C.01 Illumination at Highway-Rail Grade Crossings

#### Guidance:

When an engineering study determines that better nighttime visibility of the train and the highway-rail grade crossing is needed (for example, where a substantial amount of railroad operation is conducted at night, where train speeds are low and highway-rail grade crossings are blocked for long periods, or crash history indicates that drivers experience difficulty in seeing trains or traffic control devices during hours of darkness) illumination should be installed at and adjacent to the highway-rail grade crossing.

#### Support:

Types and location of luminaires for highway-rail grade crossing illumination are contained in the American National Standards Institute's (ANSI) "Practice for Roadway Lighting RP-8" available from the Illuminating Engineering Society (see Section 1A.11).



## **CHAPTER 8D. FLASHING-LIGHT SIGNALS, GATES, AND TRAFFIC CONTROL SIGNALS**

### **Section 8D.01 Introduction**

#### **Support:**

Active traffic control systems inform drivers, bicyclists, and pedestrians of the approach or presence of trains, locomotives, or other railroad equipment at highway-rail grade crossings.

A composite drawing (see Figure 8D-1) shows a post-mounted flashing-light signal (two light units mounted in a horizontal line), a flashing-light signal mounted on an overhead structure, and an automatic gate assembly.

#### **Option:**

Post-mounted and overhead-mounted flashing-light signals may be used separately or in combination with each other as determined by an engineering study. Also, flashing-light signals may be used without automatic gate assemblies, as determined by an engineering study.

#### **Standard:**

**The meaning of flashing-light signals and gates shall be as stated in the "Uniform Vehicle Code" (see Sections 11-701 and 11-703 of the "UVC"), which is available from the National Committee on Uniform Traffic Laws and Ordinances (see Page i for the address).**

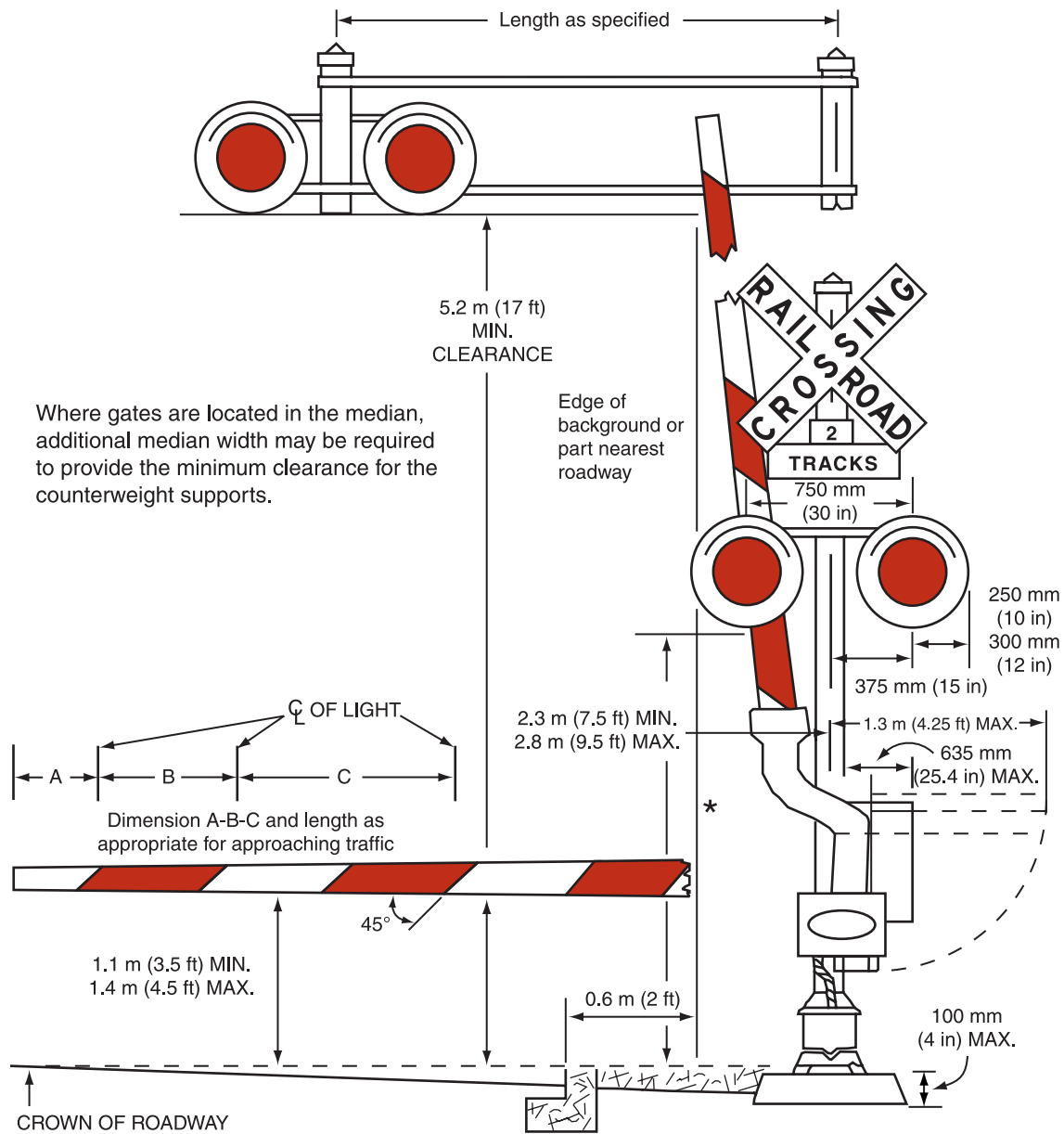
**Location and clearance dimensions for flashing-light signals and gates shall be as shown in Figure 8D-1.**

**When there is a curb, a horizontal clearance of at least 0.6 m (2 ft) shall be provided from the face of the vertical curb to the closest part of the signal or gate arm in its upright position. When a cantilevered-arm flashing-light signal is used, the vertical clearance shall be at least 5.2 m (17 ft) above the crown of the highway to the lowest point of the signal unit.**

**Where there is a shoulder, but no curb, a horizontal clearance of at least 0.6 m (2 ft) from the edge of a paved or surfaced shoulder shall be provided, with a clearance of at least 1.8 m (6 ft) from the edge of the traveled way.**

**Where there is no curb or shoulder, the minimum horizontal clearance shall be 1.8 m (6 ft) from the edge of the traveled way.**

**Figure 8D-1. Composite Drawing of Active Traffic Control Devices for Highway-Rail Grade Crossings Showing Clearances**



\*For locating this reference line at other than curb section installation, see Section 8D.01.

**Guidance:**

Equipment housings (controller cabinets) should have a lateral clearance of at least 9 m (30 ft) from the edge of the highway, and where railroad property and conditions allow, at least 7.6 m (25 ft) from the nearest rail.

If a pedestrian route is provided, sufficient clearance from supports, posts, and gate mechanisms should be maintained for pedestrian travel.

When determined by an engineering study, a lateral escape route to the right of the highway in advance of the highway-rail grade crossing traffic control devices should be kept free of guardrail or other ground obstructions. Where guardrail is not deemed necessary or appropriate, barriers should not be used for protecting signal supports.

The same lateral clearance and roadside safety features should apply to flashing-light signal and automatic gate locations on both the right and left sides of the roadway.

**Option:**

In industrial or other areas involving only low-speed highway traffic or where signals are vulnerable to damage by turning truck traffic, guardrail may be installed to provide protection for the signal assembly.

In-Roadway Stop Line Lights and In-Roadway Warning Lights (see Section 4L.03) may be installed at highway-rail grade crossings that are controlled by active grade crossing warning systems.

**Section 8D.02 Flashing-Light Signals, Post-Mounted****Standard:**

**The flashing-light signal assembly (shown in Figure 8D-1) on the side of the highway shall include a standard Crossbuck (R15-1) sign, and where there is more than one track, a supplemental Number of Tracks (R15-2) sign, all of which indicate to drivers, bicyclists, and pedestrians the location of a highway-rail grade crossing.**

**Option:**

Bells or other audible warning devices may be included in the assembly and may be operated in conjunction with the flashing lights to provide additional warning for pedestrians and bicyclists.

**Standard:**

**When indicating the approach or presence of a train, the flashing-light signal shall display toward approaching highway traffic two red lights mounted in a horizontal line flashing alternately.**

**Flashing-light signals shall be placed to the right of approaching highway traffic on all highway approaches to a highway-rail grade crossing. They shall be located laterally with respect to the highway in conformance with Figure 8D-1 except where such location would adversely affect signal visibility.**

**At highway-rail grade crossings with highway traffic in both directions, back-to-back pairs of lights shall be placed on each side of the tracks. On multi-lane one-way streets and divided highways, flashing light signals shall be placed on the approach side of the highway-rail grade crossing on both sides of the roadway or shall be placed above the highway.**

**Each red signal unit in the flashing-light signal shall flash alternately. The number of flashes per minute for each lamp shall be 35 minimum and 65 maximum. Each lamp shall be illuminated approximately the same length of time. Total time of illumination of each pair of lamps shall be the entire operating time. Flashing-light units shall use either 200 mm (8 in) or 300 mm (12 in) nominal diameter lenses.**

**Guidance:**

In choosing between the 200 mm (8 in) or 300 mm (12 in) nominal diameter lenses for use in highway-rail grade crossing flashing-light signals, consideration should be given to the principles stated in Section 4D.15. In choosing between the two sizes of backgrounds behind the lenses (see Figure 8D-1), the 250 mm (10 in) radius background should be used with the 200 mm (8 in) diameter lenses and the 300 mm (12 in) radius background should be used with the 300 mm (12 in) diameter lenses, unless the required lateral clearances cannot be met when using the 300 mm (12 in) radius background.

**Standard:**

**Highway-rail grade crossing flashing-light signals shall operate at a low voltage using storage batteries either as a primary or stand-by source of electrical energy. Provision shall be made to provide a source of energy for charging batteries.**

**Option:**

Additional pairs of flashing-light units may be mounted on the same supporting post and directed toward vehicular traffic approaching the highway-rail grade crossing from other than the principal highway route, such as where there are approaching routes on highways closely adjacent to and parallel to the railroad.

**Section 8D.03 Flashing-Light Signals, Overhead Structures**

Option:

Flashing-light signals may be installed on overhead structures or cantilevered supports as shown in Figure 8D-1 where needed for additional emphasis, or for better visibility to approaching traffic, particularly on multi-lane approaches or highways with profile restrictions.

If it is determined by an engineering study that one set of flashing lights on the cantilever arm is not sufficiently visible to road users, one or more additional sets of flashing lights may be mounted on the supporting post and/or on the cantilever arm.

**Standard:**

**Breakaway or frangible bases shall not be used for overhead structures or cantilevered supports.**

**Section 8D.04 Automatic Gates**

Support:

An automatic gate is a traffic control device used as an adjunct to flashing-light signals.

**Standard:**

**The automatic gate (see Figure 8D-1) shall consist of a drive mechanism and a fully retroreflectorized red- and white-striped gate arm with lights. When in the down position, the gate arm shall extend across the approaching lanes of highway traffic.**

**In the normal sequence of operation, the flashing-light signals and the lights on the gate arm (in its normal upright position) shall be activated immediately upon detection of the approaching train. The gate arm shall start its downward motion not less than 3 seconds after the flashing-light signals start to operate, shall reach its horizontal position at least 5 seconds before the arrival of the train, and shall remain in the down position as long as the train occupies the highway-rail grade crossing.**

**When the train clears the highway-rail grade crossing, and if no other train is detected, the gate arm shall ascend to its upright position, following which the flashing lights and the lights on the gate arm shall cease operation.**

**Gate arms shall be fully retroreflectorized on both sides, have 45-degree diagonal stripes alternately red and white at 400 mm (16 in) intervals measured horizontally, and shall have at least three red lights as indicated in Figure 8D-1.**

**When activated, the gate arm light nearest the tip shall be illuminated continuously and the other lights shall flash alternately in unison with the flashing-light signals.**

**The approach lane gate arm mechanism shall be designed to fail safe in the down position.**

Guidance:

The gate arm should ascend to its upright position in not more than 12 seconds.

In its normal upright position, when no train is approaching or occupying the highway-rail grade crossing, the gate arm should be either vertical or nearly so (see Figure 8D-1).

In the design of individual installations, consideration should be given to timing the operation of the gate arm to accommodate large and/or slow-moving vehicles.

The gates should cover the approaching highway to block all motor vehicles from being driven around the gate without crossing the centerline.

Option:

Automatic gate installations may include median islands between opposing lanes on an approach to a highway-rail grade crossing.

Where gates are located in the median, additional median width may be required to provide the minimum clearance for the counterweight supports.

### **Section 8D.05 Four-Quadrant Gate Systems**

Option:

Four-Quadrant Gate systems may be installed to improve safety at highway-rail grade crossings based on an engineering study when less restrictive measures, such as automatic gates and median islands, are not effective.

**Standard:**

**A Four-Quadrant Gate system shall consist of a series of automatic gates used as an adjunct to flashing-light signals to control traffic on all lanes at the highway-rail grade crossing.**

**The Four-Quadrant Gate system shall consist of a drive mechanism and fully retroreflectorized red- and white-striped gate arms with lights, and when in the**



**down position the gate arms extend individually across the approach and exit lanes of highway traffic as shown in Figure 8D-2. Standards contained in Sections 8D.01 through 8D.03 for flashing-light signals shall be followed for signal specifications, location, and clearance distances.**

**In the normal sequence of operation, the flashing-light signals and the lights on the gate arms (in their normal upright positions) shall be activated immediately upon detection of the approaching train. The gate arms for the approach lanes of traffic shall start their downward motion not less than 3 seconds after the flashing-light signals start to operate and shall reach their horizontal position at least 5 seconds before the arrival of the train. Exit lane gate arm activation and downward motion shall be based on detection or timing requirements established by an engineering study of the individual site. The gate arms shall remain in the down position as long as the train occupies the highway-rail grade crossing.**

**When the train clears the highway-rail grade crossing, and if no other train is detected, the gate arms shall ascend to their upright positions, following which the flashing lights and the lights on the gate arms shall cease operation.**

**Gate arm design, colors, and lighting requirements shall be in accordance with the Standards contained in Section 8D.04.**

**Except as noted in the Option below, the exit lane gate arm mechanism shall be designed to fail-safe in the up position.**

**At locations where gate arms are offset a sufficient distance for vehicles to drive between the approach and exit lane gate arms, median islands shall be installed in accordance with the needs established by an engineering study.**

Guidance:

The gate arm should ascend to its upright position in not more than 12 seconds.

Four-Quadrant Gate systems should only be used in locations with constant-warning-time train detection.

The operating mode of the exit lane gates should be determined based upon an engineering study.

If the Timed Exit Lane Gate Operating Mode is used, the engineering study should also determine the Exit Lane Gate Clearance Time (see Section 8A.01).

If the Dynamic Exit Lane Gate Operating Mode is used, vehicle intrusion detection devices should be installed to control exit lane gate operation based on vehicle presence within the minimum track clearance distance.



Regardless of which exit lane gate operating mode is used, the Exit Lane Gate Clearance Time should be considered when determining additional time requirements for the Minimum Warning Time.

If a Four-Quadrant Gate system is used at a location that is adjacent to an intersection that could cause vehicles to queue within the minimum track clearance distance, the Dynamic Exit Lane Gate Operating Mode should be used unless an engineering study indicates otherwise.

If a Four-Quadrant Gate system is interconnected with a highway traffic signal, backup or standby power should be considered for the highway traffic signal. Also, circuitry should be installed to prevent the highway traffic signal from leaving the track clearance green interval until all of the gates are lowered.

At locations where sufficient space is available, exit lane gates should be set back from the track a distance that provides a safe zone long enough to accommodate at least one design vehicle between the exit lane gate and the nearest rail.

Four-Quadrant Gate systems should include remote health (status) monitoring capable of automatically notifying railroad signal maintenance personnel when anomalies have occurred within the system.

Option:

Exit lane gate arms may fail in the down position if the highway-rail grade crossing is equipped with remote health (status) monitoring.

Four-Quadrant Gate installations may include median islands between opposing lanes on an approach to a highway-rail grade crossing.

Guidance:

Where sufficient space is available, median islands should be at least 18 m (60 ft) in length.

## **Section 8D.06 Train Detection**

**Standard:**

**The devices employed in active traffic control systems shall be actuated by some form of train detection.**

**Train detection circuits, insofar as practical, shall be designed on the fail-safe principle.**

**Flashing-light signals shall operate for at least 20 seconds before the arrival of any train, except as noted in the Option below.**

Option:

On tracks where all trains operate at less than 32 km/h (20 mph) and where flagging is performed by an employee on the ground, a shorter signal operating time for the flashing-light signals may be used.

Additional warning time may be provided when determined by an engineering study.

Guidance:

Where the speeds of different trains on a given track vary considerably under normal operation, special devices or circuits should be installed to provide reasonably uniform notice in advance of all train movements over the highway-rail grade crossing. Special control features should be used to eliminate the effects of station stops and switching operations within approach control circuits to prevent excessive activation of the traffic control devices while trains are stopped on or switching upon the approach track control circuits.

#### **Section 8D.07 Traffic Control Signals at or Near Highway-Rail Grade Crossings**

Option:

Traffic control signals may be used instead of flashing-light signals to control road users at industrial highway-rail grade crossings and other places where train movements are very slow, such as in switching operations.

**Standard:**

**The appropriate provisions of Part 4 relating to traffic control signal design, installation, and operation shall be applicable where traffic control signals are used to control road users instead of flashing-light signals at highway-rail grade crossings.**

**Traffic control signals shall not be used instead of flashing-light signals to control road users at a mainline highway-rail grade crossing.**

Guidance:

The highway agency with jurisdiction, the regulatory agency with statutory authority, if applicable, and the railroad company should jointly determine the preemption operation at highway-rail grade crossings adjacent to signalized highway intersections.

If a highway-rail grade crossing is equipped with a flashing-light signal system and is located within 60 m (200 ft) of an intersection or mid-block location controlled by a traffic control signal, the traffic control signal should be provided with preemption in accordance with Section 4D.13.

Coordination with the flashing-light signal system, queue detection, or other alternatives should be considered for traffic control signals located farther than 60 m (200 ft) from the highway-rail grade crossing. Factors to be considered should include traffic volumes, vehicle mix, vehicle and train approach speeds, frequency of trains, and queue lengths.

**Standard:**

**If preemption is provided, the normal sequence of traffic control signal indications shall be preempted upon the approach of trains to avoid entrapment of vehicles on the highway-rail grade crossing by conflicting aspects of the traffic control signals and the highway-rail grade crossing flashing-light signals.**

**This preemption feature shall have an electrical circuit of the closed-circuit principle, or a supervised communication circuit between the control circuits of the highway-rail grade crossing warning system and the traffic control signal controller. The traffic control signal controller preemptor shall be activated via the supervised communication circuit or the electrical circuit that is normally energized by the control circuits of the highway-rail grade crossing warning system. The approach of a train to a highway-rail grade crossing shall de-energize the electrical circuit or activate the supervised communication circuit, which in turn shall activate the traffic control signal controller preemptor. This shall establish and maintain the preemption condition during the time the highway-rail grade crossing warning system is activated, except that when crossing gates exist, the preemption condition shall be maintained until the crossing gates are energized to start their upward movement. When multiple or successive preemptions occur, train activation shall receive first priority.**

**Guidance:**

If a highway-rail grade crossing is located within 15 m (50 ft) (or within 23 m (75 ft) for a highway that is regularly used by multi-unit vehicles) of an intersection controlled by a traffic control signal, the use of pre-signals to control traffic approaching the grade crossing should be considered.

**Standard:**

**If used, the pre-signals shall display a red signal indication during the track clearance portion of a signal preemption sequence to prohibit additional vehicles from crossing the railroad track.**

**Guidance:**

Consideration should be given to using visibility-limited signal faces (see Section 4A.02) at the intersection for the signal faces that control the approach that is equipped with pre-signals.

**Option:**

The pre-signal phase sequencing may be timed with an offset from the signalized intersection such that the railroad track area and the area between the railroad track and the downstream signalized intersection is generally kept clear of stopped vehicles.

**Standard:**

**If a pre-signal is installed at an interconnected highway-rail grade crossing near a signalized intersection, a STOP HERE ON RED (R10-6) sign shall be installed near the pre-signal or at the stop line if used. If there is a nearby signalized intersection with insufficient clear storage distance for a design vehicle, or the highway-rail grade crossing does not have gates, a NO TURN ON RED (R10-11) sign shall be installed for the approach that crosses the railroad track.**

**Option:**

At locations where a highway-rail grade crossing is located more than 15 m (50 ft) (or more than 23 m (75 ft) for a highway regularly used by multi-unit vehicles) from an intersection controlled by a traffic control signal, a pre-signal may be used if an engineering study determines a need.

If highway traffic signals must be located within close proximity to the flashing-light signal system, the highway traffic signals may be mounted on the same overhead structure as the flashing-light signals.

**Support:**

Section 4D.13 describes additional considerations regarding preemption of traffic control signals at or near highway-rail grade crossings.